

Satel®

INT-SZ

Code lock

CE

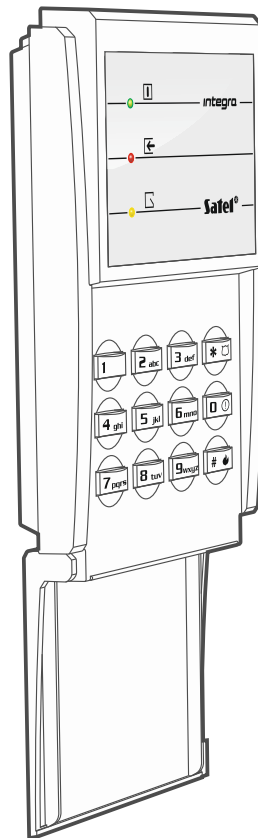

Firmware version 2.02

int-sz_en 08/20

SATEL sp. z o.o. • ul. Budowlanych 66 • 80-298 Gdańsk • POLAND
tel. +48 58 320 94 00
www.satel.eu

IMPORTANT

The device should be installed by qualified personnel.

Read carefully this manual before proceeding to installation.

Changes, modifications or repairs not authorized by the manufacturer shall void your rights under the warranty.

SATEL aims to continually improve the quality of its products, which may result in changes in their technical specifications and software. Current information about the changes being introduced is available on our website.

Please visit us:
<http://www.satel.eu>

The declaration of conformity may be consulted at www.satel.eu/ce

The following symbols may be used in this manual:





- note;



- caution.

CONTENTS

1. Features	2
2. Installation	2
2.1 Address setting	3
2.2 Description of terminals	4
3. Configuring	4
3.1 Description of parameters and options	4
4. Using	7
4.1 LED indicators	7
4.2 Sound signaling	7
4.2.1 Beeps generated when operating	7
4.2.2 Signaling events	7
4.3 Code	8
4.4 Available functions	8
4.4.1 [Code]*  / [Code]# 	8
4.4.2 Triggering the alarm from keypad	8
4.4.3 Code changing	8
5. Specifications	8

The INT-SZ code lock can control the access to a single door. The device can be used in conjunction with the INTEGRA and INTEGRA Plus control panels. The code lock is offered in two versions differing in key backlight color:

INT-SZ-GR – green backlight,

INT-SZ-BL – blue backlight.

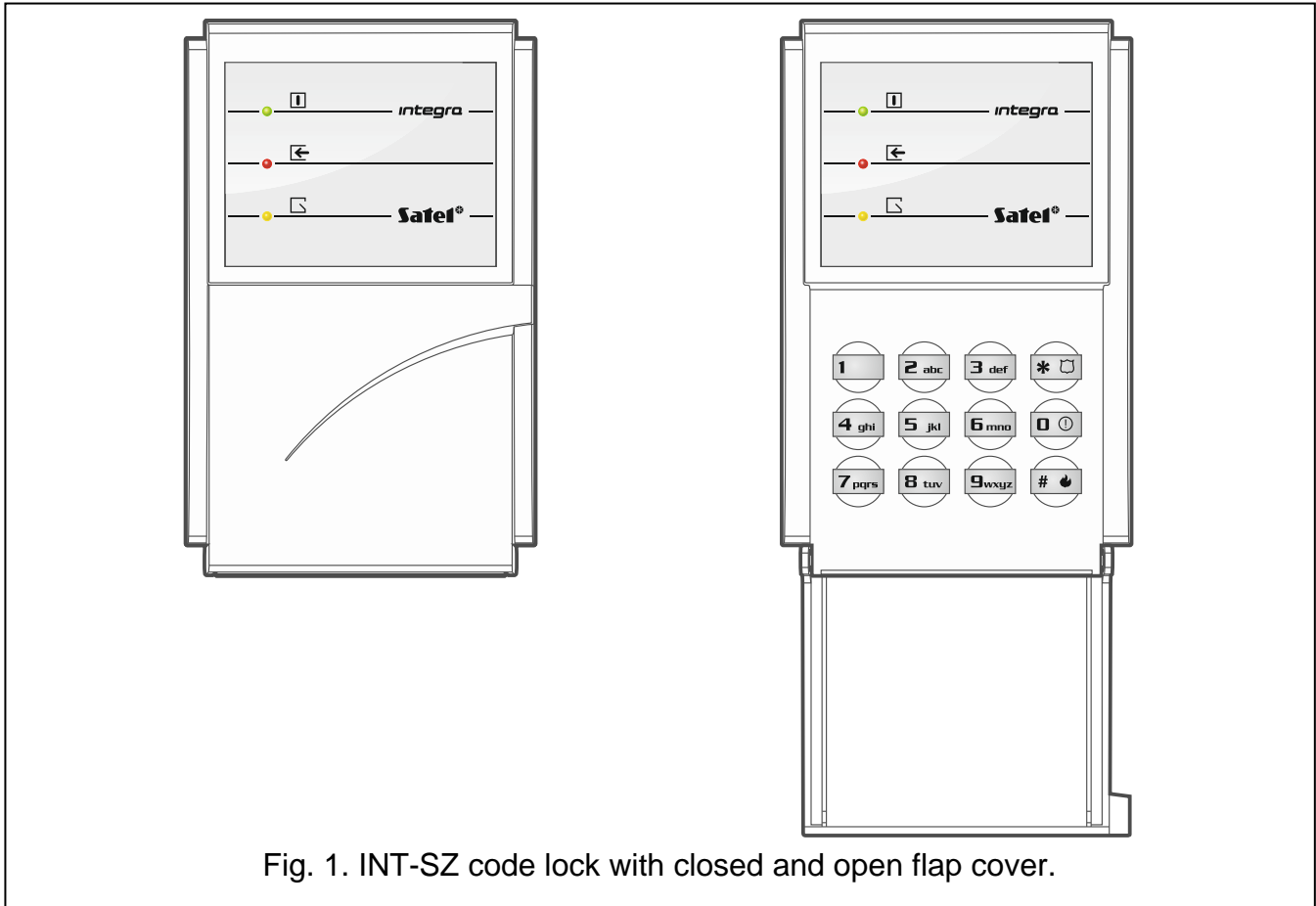

Fig. 1. INT-SZ code lock with closed and open flap cover.

1. Features

- Single door control:
 - relay output for control of electric strike, electromagnetic lock or another door actuator,
 - door status input (NC).
- Capability of triggering alarm from the keypad.
- Control of “24. MONO switch” and “25. BI switch” type outputs.
- The ability to change access code by the user.
- LEDs indicating the lock and door status.
- 12 keys with backlighting.
- Built-in sounder.
- Tamper protection against enclosure opening and removal from the wall.

2. Installation



Disconnect power before making any electrical connections.

The code lock is designed for indoor installation. The place of installation should be readily accessible to the system users.

1. Open the code lock enclosure.
2. Set the code lock address (see "Address setting" p. 3).
3. Place the enclosure base on the wall and mark the location of mounting holes.
4. Drill the holes for wall plugs (anchors).
5. Run the wires through the opening in the enclosure base.
6. Using wall plugs (anchors) and screws, fasten the enclosure base to the wall. Select wall plugs specifically intended for the mounting surface (different for concrete or brick wall, different for drywall, etc.).
7. Connect the CLK, DTA and COM terminals to the appropriate terminals of the control panel expander bus (see the control panel installer manual). It is recommended that an unshielded non-twisted cable be used for making the connection. If you use the twisted-pair type of cable, remember that CLK (clock) and DTA (data) signals must not be sent through one twisted-pair cable. The wires must be run in one cable.
8. Connect the wires for control of electric strike, electromagnetic lock or another door actuator to the NO terminals (see Fig. 2). It is not recommended that the door actuator be powered from the same source as the code lock.

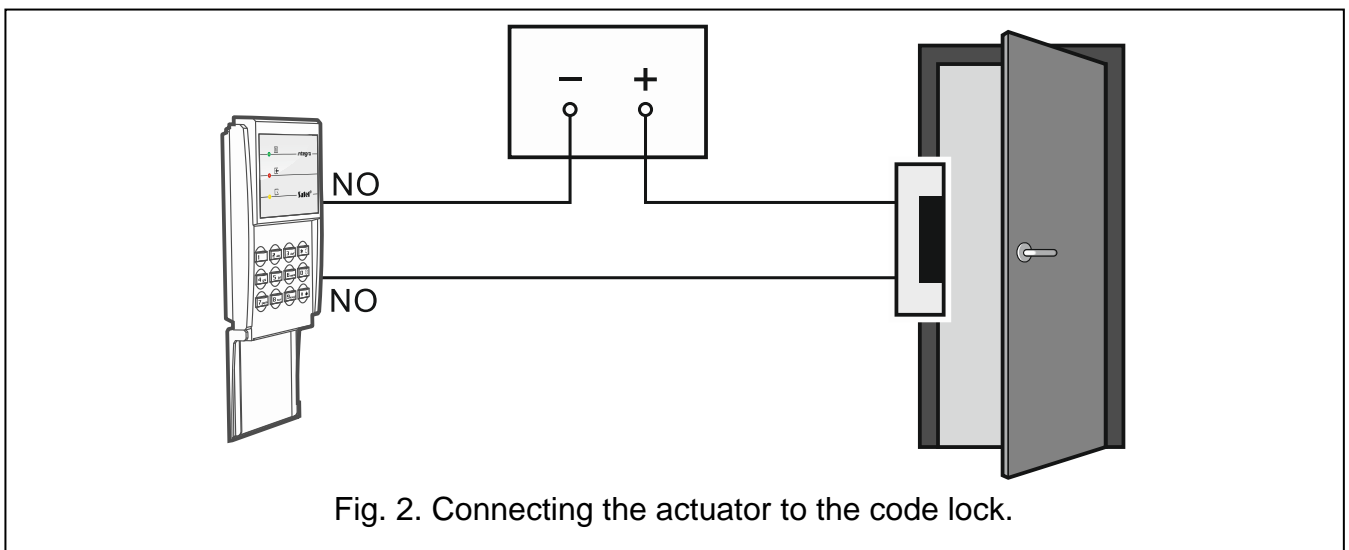

Fig. 2. Connecting the actuator to the code lock.

9. If the code lock is to supervise the door status, connect the detector supervising the door status to the IN and COM terminals. If the code lock is not to supervise the door status, connect the IN terminal to the COM terminal or, when configuring the code lock, set value 0 for the "Max. door open time" parameter.
10. Connect the power wires to the 12V and COM terminals. The code lock may be powered directly from the control panel, from an expander with power supply or from a power supply unit.
11. Close the enclosure.
12. Power on the alarm system.
13. Start the identification function in the control panel (see the control panel installer manual). The code lock will be identified as "INT-SZ/SZK".

2.1 Address setting

An individual address (different from that in the other devices connected to the control panel bus) must be set in the code lock.

To set the address, use the DIP switches on the electronics board. The switches have numbers assigned to them. The number for OFF position is 0. The numbers assigned to the switches in ON position are presented in the table 1. The sum of these numbers is the address set.

Switch (ON position)	1	2	3	4	5
Number	1	2	4	8	16

Table 1.

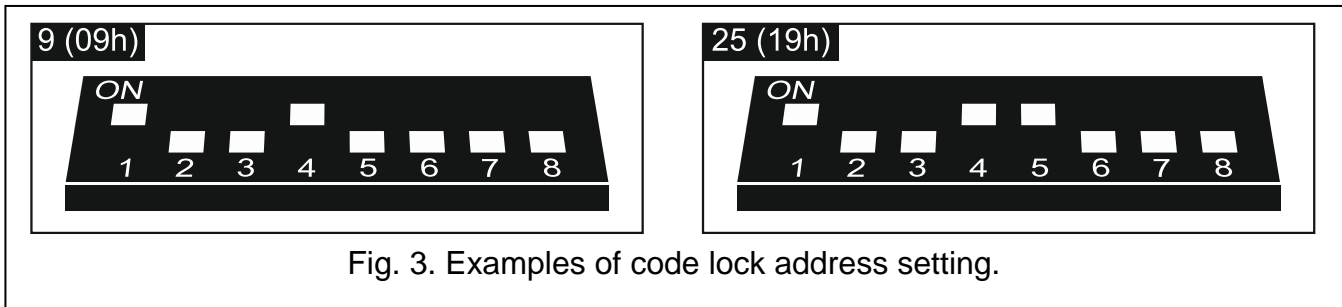

Fig. 3. Examples of code lock address setting.

2.2 Description of terminals

- NO** - relay output
- 12V** - power input
- DTA** - data (expander communication bus)
- CLK** - clock (expander communication bus)
- COM** - common ground
- IN** - door status input (NC)

3. Configuring

The code lock settings you can configure using:

- DLOADX program: →“Structure” window →“Hardware” tab →“Expansion modules” branch →[code lock name],
- LCD keypad: ▶“Service mode” ▶“Structure” ▶“Hardware” ▶“Expanders” ▶“Settings” ▶[code lock name].

3.1 Description of parameters and options

Names of parameters and options from the DLOADX program are used in this manual. Shown in square brackets at the description of a parameter or option is the name presented on the display of the LCD keypad.

Name – individual name of the device (up to 16 characters).

Partition – partition to which the code lock belongs (alarms will be triggered in this partition).

Lock features [Lock function] – mode of operation of the relay output after the access is granted:

Fixed ON time [ON time] – the relay output will be turned on for the “Relay ON time”.

Fixed ON time – OFF if door open [ON, open→off] – the relay output will be turned on until the door is opened (door status input is disconnected from common ground), however not longer than for the “Relay ON time”.

Fixed ON time – OFF if door closed [ON, close→off] – the relay output will be turned on until the door is closed (door status input is reconnected to common ground), however not longer than for the “Relay ON time”.

Relay ON time – the time during which the relay output can be turned on after the access is granted. You can program from 1 to 255 seconds.

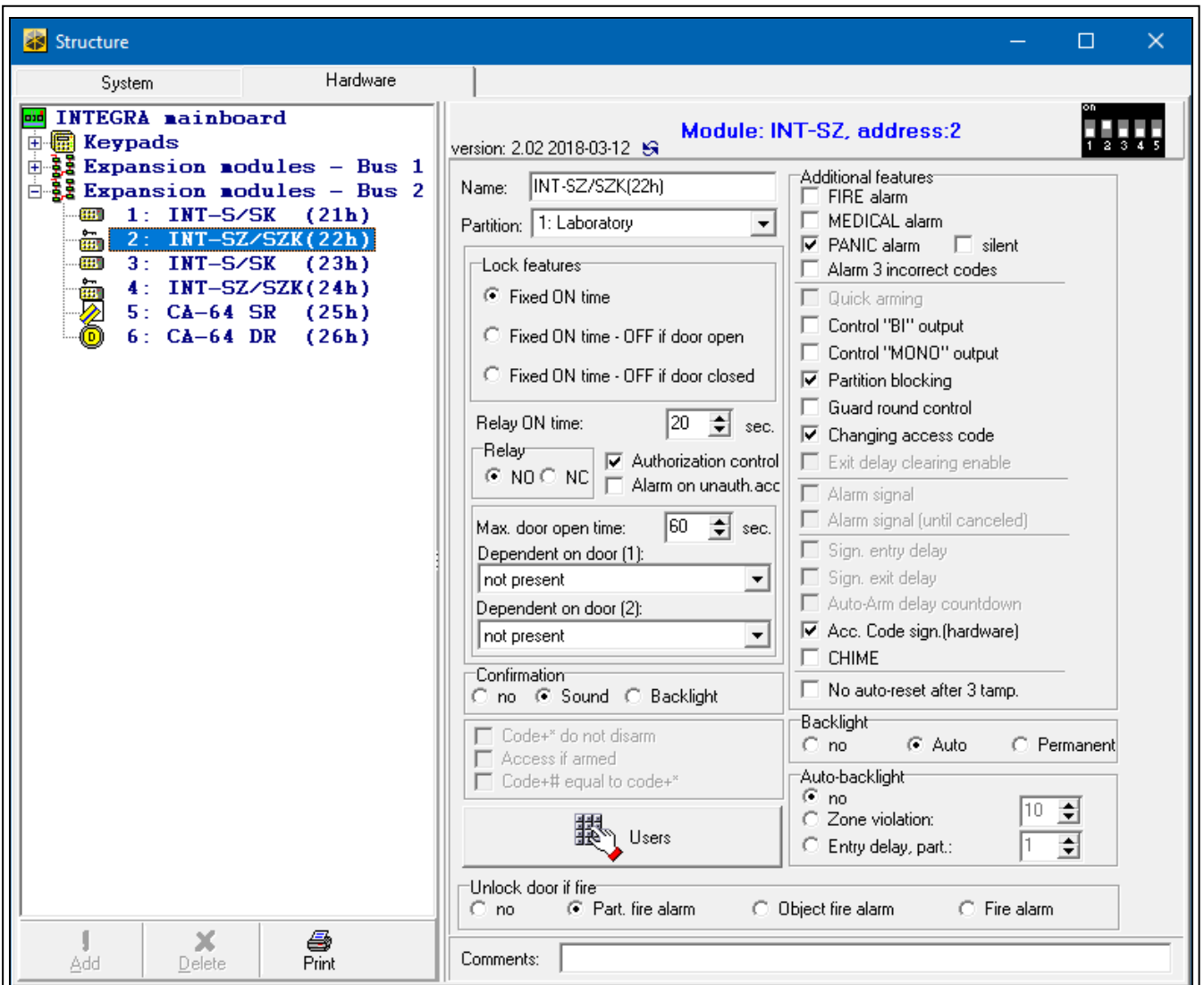

Fig. 4. DLOADX program: parameters and options of code lock.

Relay [Relay type] – status of the deactivated relay:

NO [Normal.open NO] – the relay contacts are open (they close on activating the relay).

NC [Normal.closed NC] – the relay contacts are closed (they open on activating the relay).

Authorization control [Unauth. event] – if this option is enabled, unauthorized opening of the door will save the event to the control panel memory.

Alarm on unauth. access [Unauth. alarm] – if this option is enabled, unauthorized opening of the door when the partition is armed will trigger an alarm. The option is available if the “Authorization control” option is enabled.

Max. door open time [Max. door open] – the maximum period of time during which the door can be open (the door status input can be disconnected from common ground). If the door is open longer, audible alarm will be triggered in the code lock, and the event will be saved to the control panel memory. You can enter from the 0 to 255 seconds. If you enter 0, the door can be open for (any long period of time).

Dependent on door (1) / Dependent on door (2) – you can select the door that must be closed so that the user can get access (turn the relay output on). It allows you to create an airlock. You may select a door supervised by another expander or alarm system zone programmed as type “57 Technical – door open”.

Confirmation – method of providing feedback to the user after using the code lock:

No – no feedback.

Sound – the code lock will use sounds to give feedback to the user.

Backlight – the code lock will use key backlight to give feedback to the user.

Users [Master users / Users] – the administrators and users which are permitted to use the code lock.

FIRE alarm – if this option is enabled, pressing and holding  for 3 seconds will trigger the fire alarm.

AUX. alarm [Medical alarm] – if this option is enabled, pressing and holding  for 3 seconds will trigger the medical alarm.

PANIC alarm – if this option is enabled, pressing and holding  for 3 seconds will trigger the panic alarm.

silent [Silent panic] – if this option is enabled, the panic alarm triggered from the keypad will be a silent one, i.e. the code lock will not indicate it, there will be no audible signal, but the alarm will be reported to the monitoring station. The silent panic alarm is useful when the control panel is sending events to the monitoring station, but unauthorized persons should not be aware of the alarm being triggered. This option is available, if the “PANIC alarm” option is enabled.

Alarm 3 incorrect codes [3 wrong codes] – if this option is enabled, entering a wrong code three times will trigger an alarm.

Control “BI” output [BI outs ctrl.] – if this option is enabled, the ““BI” output operating” type of users can use the code lock to control outputs.

Control “MONO” output [MONO outs ctr.] – if this option is enabled, the ““Mono” output operating” type of users can use the code lock to control outputs.

Partition blocking [Part.blocking] – if this option is enabled, using the code by a user of the “Blocking partition” or “Guard” type will block the armed partition (violating a zone belonging to the partition will trigger no alarm). The duration of blocking is to be defined for the partition or the user (the user of “Blocking partition” type).

Guard round control [Guard control] – if this option is enabled, using the code by a user of the “Guard” type will be registered as the guard round.

Changing access code [Changing code] – if this option is enabled, the user can change own code from the code lock.

Acc. code sign. (hardware) [Code entered] – if this option is enabled, the code lock will confirm with a single beep that the code has been entered. The signaling is useful when there is a delay between entering the code and the sounds emitted after verification of the code by the control panel.

CHIME [Chime zones] – if this option is enabled, the code lock will audibly signal violation of zones with “Chime in module” option enabled, belonging to the same partition as code lock.

No auto-reset after 3 tamp. [No autorst.3t.] – if this option is enabled, the feature reducing the number of tamper alarms from the module to three is disabled (the feature prevents multiple logging of the same events and applies to successive uncleared alarms).

Backlight – keys backlight operation mode:

No – always off.

Auto – on for about 40 seconds after pressing any key. Additionally, it can be turned on if a specific event occurs (see the “Auto-backlight” parameter).

Permanent – always on.

Auto-backlight – if the keys backlight comes on automatically, you can additionally define whether and what event will turn the backlight on:

No – the keys backlight will not be additionally turned on.

Zone violation – the keys backlight will additionally go on if a selected zone is violated.

Entry delay, part. – the keys backlight will additionally go on if entry delay countdown starts in the selected partition.

Unlock door if fire [Doors on fire] – you can define whether and when the fire alarm will unlock the door controlled by the code lock (i.e. will activate the relay output):

No [no open] – the door will not be unlocked in the event of fire alarm.



Part. fire alarm [on partit. fire] – the door will be unlocked in the event of fire alarm in the partition to which the code lock belongs.

Object fire alarm [on object fire] – the door will be unlocked in the event of fire alarm in the object to which the code lock belongs.

Fire alarm [on any fire] – the door will be unlocked in the event of fire alarm in the alarm system.

4. Using

4.1 LED indicators

LED	Color	Description
	green	ON – code lock is operated by the control panel
	red	ON – access granted – door unlocked
	yellow	flashing – door open



All LEDs flashing in turn indicate that there is no communication with the control panel.

4.2 Sound signaling

4.2.1 Beeps generated when operating



The installer can disable the sound signaling or replace it with flashing of the keys backlight (see “Configuring”).

1 short beep – any number key is pressed or the code is used.

4 short and 1 long beeps – confirmation of door unlocking or execution of another function.

3 pairs of short beeps – code change is required.

2 long beeps – unknown code.

3 long beeps – unavailable function.

4.2.2 Signaling events



The installer defines whether events are to be signaled audibly (see “Configuring”).

5 short beeps – zone violation (CHIME).

Very short beeps – door open too long.

4.3 Code

Most of the functions are available after entering the code. By factory default, the following codes are programmed in the control panel:

service code: 12345

object 1 master user (administrator) code: 1111



The factory default codes should be changed before you start using your alarm system



Do not make your code available to other people.

4.4 Available functions

Availability of the functions depends on:

- type and rights of the user,
- code lock settings,
- partition state.

4.4.1 [Code]* / [Code]#



Enter the code and press  or  to:

- gain access (turn on the code lock relay output),
- toggle the state of “25. BI switch” type outputs,
- turn on the “24. MONO switch” type outputs,
- confirm the guard round,
- temporary block the partition.

4.4.2 Triggering the alarm from keypad

The installer can permit triggering alarms from the keypad. To trigger an alarm, do the following:







fire alarm – press and hold down  for about 3 seconds,

medical (auxiliary) alarm – press and hold down   for about 3 seconds,

panic alarm – press and hold down  for about 3 seconds. The installer defines whether the audible or silent panic alarm will be triggered.

4.4.3 Code changing

You can change your code if the “Changing access code” option is enabled.

1. Press and hold the  key for about 3 seconds.
2. When the  and  LEDs start flashing alternately, enter the old code and press .
3. When the  and  LEDs start flashing alternately, enter the new code and press .

5. Specifications

Supply voltage 12 VDC ±15%

Standby current consumption30 mA

Maximum current consumption80 mA

Relay output (resistive load)	1 A / 30 VDC
Environmental class according to EN50130-5	II
Operating temperature range.....	-10°C...+55°C
Maximum humidity	93±3%
Dimensions	80 x 127 x 24 mm
Weight.....	110 g