

# ASP-100

## WIRELESS OUTDOOR SIREN

asp-100\_en 03/18

The ASP-100 wireless siren provides information about alarm situations by means of optical and acoustic signaling. The siren is designed for operation within the ABAX two-way wireless system. This manual applies to the siren with firmware version 1.00, which is supported by ACU-120 and ACU-270 controllers with firmware version 5.02.

**Notes:**

- Up to 8 ASP-100 sirens can be registered in the controller.
- The siren is not supported by the ACU-100 and ACU-250 controllers, ARU-100 radio signal repeater and INTEGRA 128-WRL control panel.

### 1. Features

- Acoustic signaling by means of piezoelectric transducer.
- Optical signaling by means of LEDs.
- Remote configuration.
- Power supply from 3.6 V lithium thionyl chloride battery.
- Battery status control.
- Weatherproofed electronic circuit.
- Tamper protection against cover removal and tearing enclosure from the wall.
- High-impact polycarbonate enclosure, featuring a very high mechanical strength.

### 2. Specifications

|  |                       |
|--|-----------------------|
| Operating frequency band .....                   | 868.0 MHz ÷ 868.6 MHz |
| Radio communication range (in open area) .....   | up to 500 m           |
| Battery .....                                    | ER34615 3.6 V / 13 Ah |
| Battery life expectancy .....                    | up to 2.5 years       |
| Standby current consumption .....                | 2 mA                  |
| Maximum current consumption .....                | 65 mA                 |
| Sound pressure level (at 1 m distance) .....     | up to 105 dB          |
| Environmental class according to EN50130-5 ..... | IIIA                  |
| Operating temperature range .....                | -40°C ... +55°C       |
| Maximum humidity .....                           | 93±3%                 |
| Dimensions .....                                 | 148 x 254 x 64 mm     |
| Weight .....                                     | 860 g                 |

**Hereby, SATEL sp. z o.o., declares that this siren is in compliance with the essential requirements and other relevant provisions of Directive 2014/53/EU. The declaration of conformity may be consulted at [www.satel.eu/ce](http://www.satel.eu/ce)**

### 3. Description

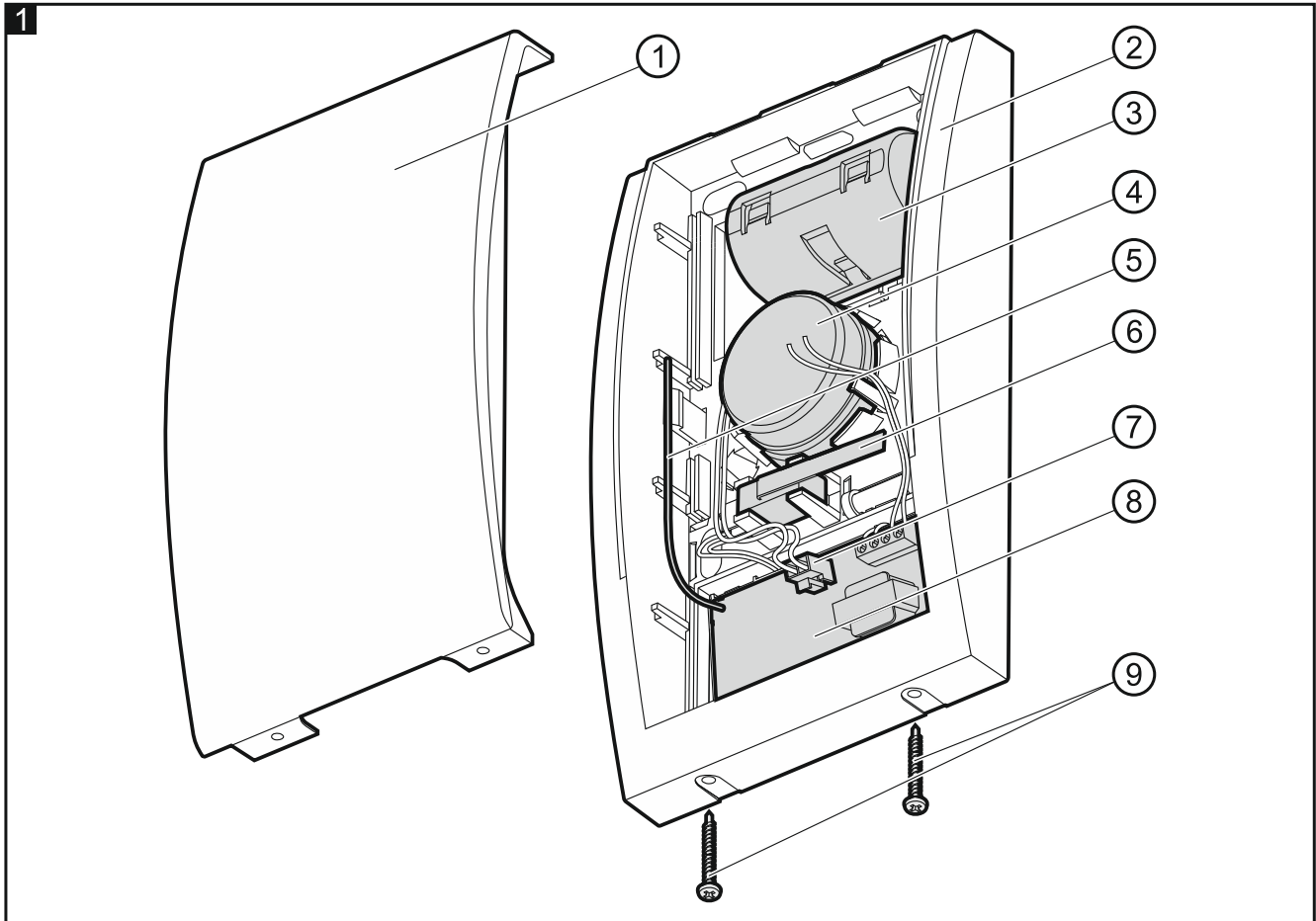

Explanations for Fig. 1:

- ① enclosure cover.
- ② enclosure base.
- ③ battery cover.
- ④ piezoelectric transducer.
- ⑤ antenna.



**Never shorten or deform the antenna.**

- ⑥ tamper switch (tamper alarm triggered if open).
- ⑦ battery connector.
- ⑧ electronics module.
- ⑨ cover locking screws.

#### Triggering the alarm signaling

The alarm signaling is triggered:

- on receiving a radio command from the controller – optical and acoustic signaling are controlled independently,
- on opening the tamper switch – both optical and acoustic signaling is triggered. Opening the tamper switch will not trigger the alarm in the following cases:
  - for 10 minutes after connecting the battery,
  - when the control panel is running in service mode (a few seconds delay may occur between entering the service mode and blocking the tamper signaling)

When the tamper signaling is blocked, the leftmost LED is blinking every 3 seconds.

Duration of the signaling and type of the acoustic signaling are remotely programmable.



|   |  |   |
|---|--|---|
| 1 | Two sound frequencies (1450 Hz/2000 Hz) alternating within 1 second                            |  |
| 2 | Sound with rising frequency (from 1450 Hz to 2000 Hz) within 1 second                          |  |
| 3 | Sound with smoothly rising and falling frequency (1450 Hz – 2000 Hz – 1450 Hz) within 1 second |  |
| 4 | Sound with falling frequency (from 2000 Hz to 1450 Hz) within 1 second                         |  |

Table 1. Tone types for acoustic signaling.

**Power supply**

The siren is powered from a 3.6 V lithium thionyl chloride battery. It is a high-current battery, characterized by high capacity. The battery is offered by SATEL.

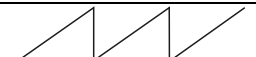
**Given the specific nature of the battery, it must be properly initialized to reach the required performance. The battery initialization procedure starts automatically after first-time connection of the battery. During battery replacement, follow the procedure described at the end of this manual to initialize a new battery.**

When initializing a battery, the leftmost LED on the siren is blinking every second. The siren will not be ready for operation until the battery initialization procedure is completed.

The siren informs about low battery.

**Periodic transmissions**

Every 15 minutes, the siren sends a transmission with information on the current status of the tamper switch and battery. Periodic transmissions are used to monitor presence and operation of the siren.

**Note:** *If any value different from 0 is programmed for the FILTER parameter for the ASP-100 siren, the lack of presence will be reported if no transmission from the detector is received within one hour.*

**Enclosure base**

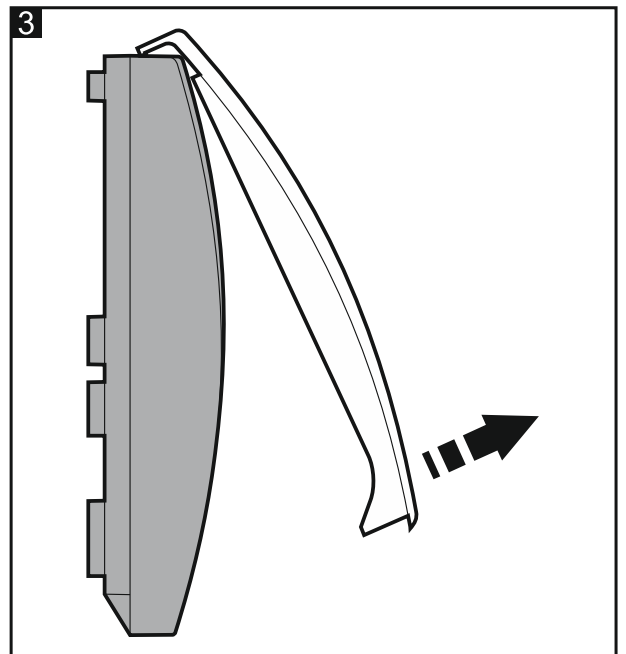
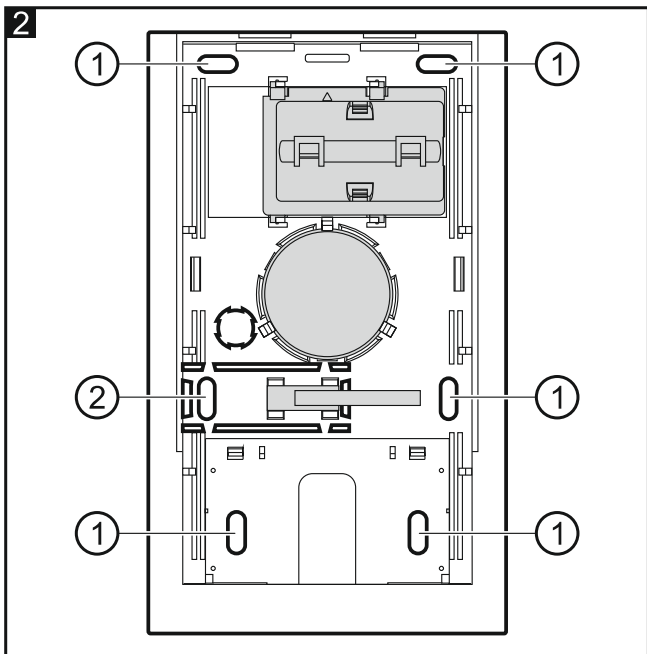

Explanations for Fig. 2:

- ① mounting hole.
- ② tamper mounting hole.

## 4. Installation and start-up

---



**There is a danger of battery explosion when using a different battery than recommended by the manufacturer, or handling the battery improperly.**

**Be particularly careful during installation and replacement of the battery. The manufacturer is not liable for the consequences of incorrect installation of the battery.**

The siren must be installed on the wall, high above the floor, at a hard to access location, so as to minimize the risk of tampering. Make sure that some free space is left above the siren (at least 2.5 cm). Otherwise, it will be impossible to replace the cover.

1. Remove the cover locking screws.
2. Lift up the enclosure cover by approx. 60° and remove it (see Fig. 3).
3. Connect the battery and add the siren to the wireless system (see the ACU-120 / ACU-270 controller manual or installer manuals for VERSA / VERSA IP / VERSA Plus control panels). The sticker with serial number which shall be entered when registering the siren in the system can be found on the electronics board.
4. Replace the siren cover.
5. Place the siren in the location intended for its installation.
6. Check the level of signal received from the siren by the ACU-120 / ACU-270 controller. If the signal level is lower than 40%, select another place for installation. Sometimes, it is sufficient to shift the device ten or twenty centimeters to obtain a considerable improvement in the signal quality.
7. Remove the siren cover.
8. Disconnect the battery.
9. Move aside the catches holding the electronics module and remove it.
10. Place the enclosure base on the wall and mark the location of mounting holes (see Fig. 2). Be sure to take into account the tamper mounting hole.
11. Drill the holes for wall plugs (screw anchors).
12. Secure the enclosure base to the wall with wall plugs (screw anchors) and screws. Remember about the tamper mounting hole. The wall plugs (screw anchors) and screws delivered with the siren are intended for brick, concrete and similar mounting surfaces. For other surfaces (e.g. drywall, wood, styrofoam), use other wall plugs (screw anchors), as required.
13. Secure the electronics module in the enclosure base.
14. Connect the battery.
15. Replace the siren cover and fasten it with screws.
16. Configure the siren (set the signaling duration, type of acoustic signaling, etc.). For detailed information on this subject, refer to the controller manual.

## 5. Battery replacement

---



**The used batteries must not be discarded, but should be disposed of in accordance with the existing rules for environment protection.**

1. Start the service mode in the control panel.
2. After the leftmost LED on the siren starts blinking every 3 seconds, you can open the siren enclosure.
3. Disconnect the battery.
4. Remove the battery cover (grasp the upper part of the cover with your fingers and pull it down).
5. Remove the old battery and place the new one in the battery cover.
6. Install the battery cover in the siren enclosure.
7. Press and hold down the tamper switch.
8. Connect the new battery.
9. When the leftmost LED on the siren starts blinking every second, release the tamper switch.