



The APS-1012 power supply unit has been designed for use with 12 V DC electrical installations (e.g. access control systems). Due to application of an energy-efficient pulse power system, supplied directly from the mains with 230 V AC, the thermal losses have been minimized, while the reliability have been enhanced. The APS-1012 has an input interference filter and a power factor compensation system, as well as short-circuit and overload protection of output.

Precision voltage control, microprocessor-based battery charge status control and automatic cut-off of the battery function in case of its excessive discharge, enable the battery to be used longer without any risk of being damaged. For operation with the APS-1012 it is recommended to use the lead batteries 12 V 17 Ah. In the housing there is enough place to install two parallel-connected batteries, 17 Ah capacity each. It enables to use the APS-1012 two time longer in case of AC power loss.



The APS-1012 is fitted with four LEDs, which indicate: the mains supply and battery condition, current overload, and excessive temperature rise. The detected troubles are signaled on the four OC type outputs and may be additionally signaled by the buzzer. During normal operation of the APS-1012, the signaling outputs are shorted to ground (0V), but when a fault occurs, the respective output is cut off from the ground. The tamper contact, installed on the housing, makes it possible to include the APS-1012 into the tamper circuit of the alarm system.

1. Power supply description

Four LEDs are provided on the power supply housing:

- 1  – **[MAINS]** (green):
 - ON – normal operation, with 230 V AC voltage present on the input,
 - OFF – no 230 V AC voltage or F1 fuse blown (3,15 A).
- 2  – **[BATTERY]** (green):
 - ON – battery voltage OK,
 - blinking – battery voltage drop below 11 V,
 - OFF – no battery or F3 fuse blown (10 A).

Note: If there is no load at the power supply output, the  LED indication can be unstable. For a proper battery state indication, at least 200 mA load of the output is required.

- 3  – **[OVERLOAD]** (yellow):
 - OFF – normal operation.
 - ON – current consumption in excess of 10 A.
- 4  – **[TEMPERATURE]** (red):
 - OFF – normal operation
 - blinking – elevated working temperature (above 45 °C) if there is no fan, or fan trouble.
 - ON – dangerous working temperature (above 65 °C), which may cause damage to the power supply unit.

The APS-1012 is fitted with a fan, which ensures air circulation that decreases operation temperature. When power supply temperature inside housing is above 45 °C, the processor turns on the fan and, if there is no proper fan rotation, the [TEMPERATURE] LED starts blinking. When the temperature is above 65 °C the red [TEMPERATURE] LED goes on and the AWT output goes into active mode (disconnection from common ground). A drop in temperature below 65°C will extinguish the LED steady light. The fan will stop when the temperature drops below 45°C.

If the power supply output is shorted to the common ground (mount failure, cable fault) the power supply is turned off – all four LEDs start blinking. This situation last until the failure is removed. The short circuit may damage the F3 fuse in the battery circuit (if the battery was connected).

Explanations to Figure 2:

- 1 – **F1 mains fuse T3.15 A** – input circuit protection.
- 2 – **F3 fuse T10 A** – protection of battery charging circuit.
- 3 – **battery connecting cables 12 V** (red +; black -).
- 4 – **pins for setting power supply working parameters** – ● symbol on the electronics board denotes shorted pins (jumper on), ○ denotes open pins (jumper off). By default, jumpers are set on all pins.

AC FAIL DELAY – determination of the time that must elapse from the moment of AC supply failure to the moment of signaling the same on the AWS output (1800 or 10 seconds). By default, 1800 seconds.

BATT. CHARGE – determination of the battery charging current (2 A – pins open or 4 A – pins shorted). By default, 2 A.

Note: *To short the charging time of the high capacity battery the battery charging current has been changed and it is higher than shown on the electronics board.*

BATT. CHECK – battery test enabled/disabled. Disabling the test does not disable the battery discharge control feature. By default, the battery test is enabled.

BEEP – audible trouble signal enabled/disabled. By default, the buzzer is enabled.

- 5 – **buzzer** – audible trouble signal.
- 6 – **FAN** – connector for connection of a fan.

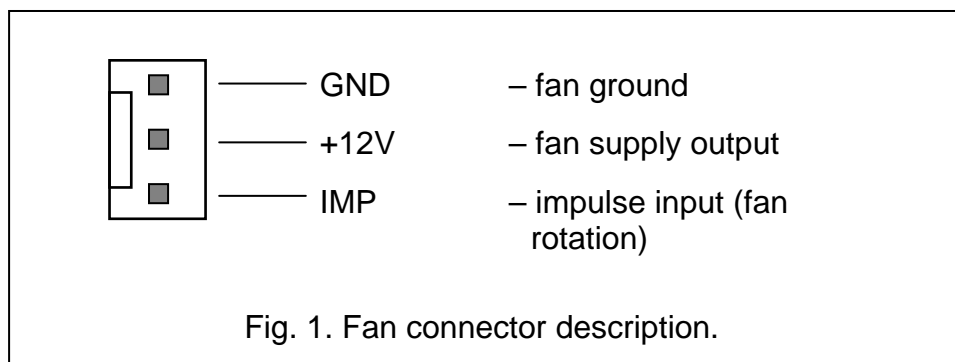

Fig. 1. Fan connector description.

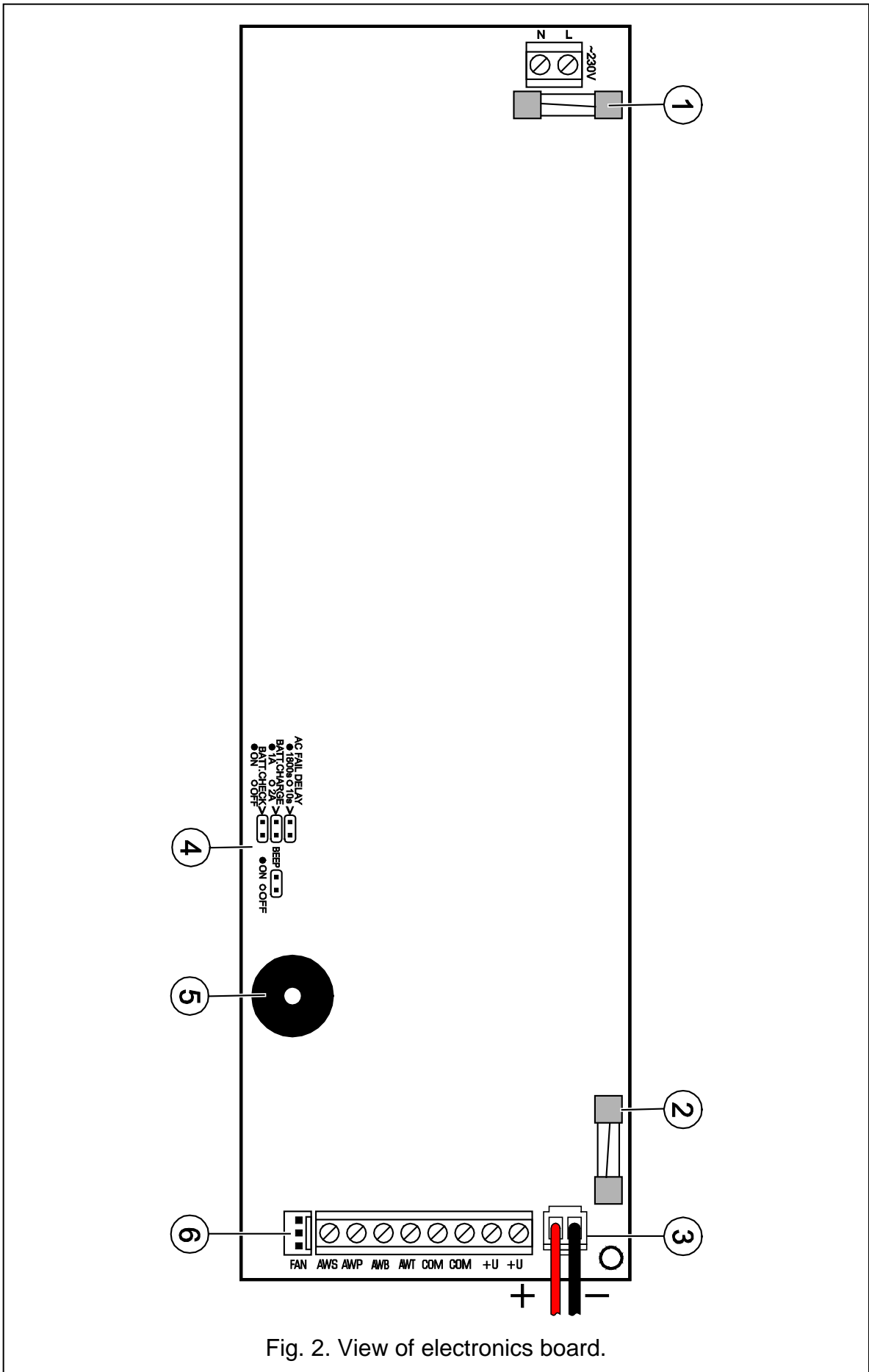

Fig. 2. View of electronics board.

Description of terminals:

- 230 and AC** – mains power supply inputs (230 V AC).
+U – power supply outputs (13.6 – 13.8 V DC). Total current capacity of outputs 10 A.
COM – common ground (0V).
AWT – alarm output (OC): excessive permissible working temperature.
AWB – alarm output (OC): low battery voltage – below 11 V.
AWP – alarm output (OC): excessive permissible overload current – current consumption over 10 A.
AWS – alarm output (OC): loss of 230 V AC – output activation delay 1800 s or 10 s.

2. Installation

Prior to commencement of installation, load balance of the power supply should be drawn up. **The current derived from the APS-1012 by external devices must not exceed 10 A.**

During operation, the APS-1012 should be permanently connected to the mains supply. Therefore, get yourself familiar with electrical installation in the building before you proceed to making the cable connections. To supply the device, you should choose a circuit which is always alive and suitably protected.

The power supply should only operate while being permanently connected to mains supply. Hence, before making the connections it is necessary to familiarize with the electric system in the facility. For powering the device choose the circuit which is always live. The power supply circuit should be protected with a proper fuse.



Before connecting a device to the power supply circuit from which it will be powered, make sure the circuit is not alive.

1. Attach the mounting (plastic) pins to the back side of the housing.
2. Mount the power supply housing in selected location and connect all electric leads .
3. Put the APS-1012 board on the pins.
4. Fix the LED board to the housing lid with two steel sheet metal screws (green LEDs in upward position).
5. Connect the 230 V AC power wires to the 230 V and AC terminals of the APS-1012. Connect the grounding wire to the terminal situated inside, on the rear panel of the metal housing and marked by the ground symbol , connect a plug of the fan to the FAN connector.
6. Connect the supply cables for external devices to the terminals +U and COM on the APS-1012 board.
7. If necessary, make use of the trouble signaling outputs (e.g. to control relays or connect to the control panel zones).

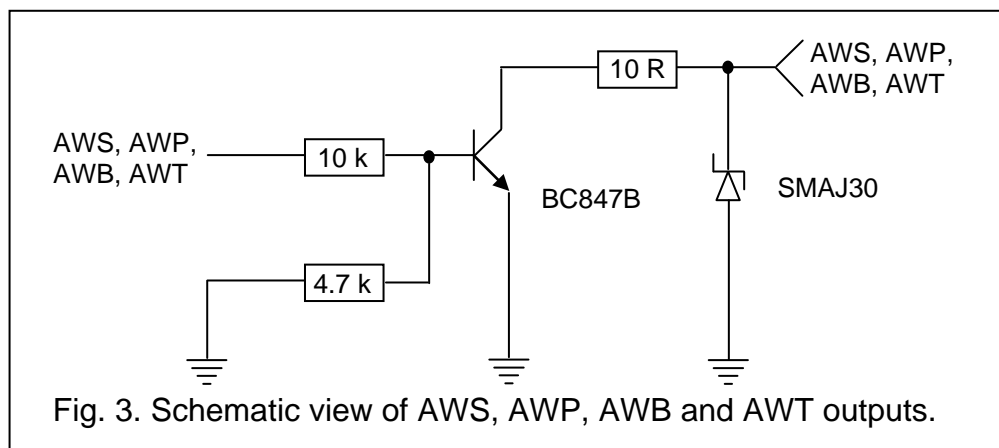



Fig. 3. Schematic view of AWS, AWP, AWB and AWT outputs.

8. By putting jumpers on the **AC FAIL DELAY** pins, set the time delay after which 230 V AC mains failure will be signaled on the AWS output. This setting specifies also the AWS output restore time (when output goes back to its normal state), which must elapse from the end of a failure.

Possible time delay settings:

- 1800 seconds –  Pins shorted
 10 seconds –  Pins open

9. Using the **BEEP** pins, determine, whether the buzzer is to signal troubles (jumper on), or not (jumper off).



In order to avoid the risk of electric shock, put and remove jumpers only in deenergized state, i.e. with power supply disconnected.

10. Connect the batteries according to the color markings.

The green LED  [BATTERY] lights up as soon as 230 V power supply is on, however the battery charge status will only be known after a full test, i.e. after approx. 12 minutes. The battery charge status check is performed every 4 minutes and lasts some ten to twenty seconds. During the tests, the processor reduces the power supply voltage to approx. 10,5 V, and the loads are switched over to battery supply. If the battery voltage drops to approx. 11 V during three consecutive cycles, the APS-1012 will report a trouble, and when the voltage drops down to 9,5 V, the APS-1012 will disconnect the battery to prevent it from being fully discharged and damaged.





After completion of the test, the LED will remain ON if the APS-1012 detects presence of a charged battery, or will start blinking if the battery is discharged, or will go out, if there is no battery supply.

Note: *If the battery is not detected after reconnection, the power supply circuit will only detect the presence of the battery on the AWB output when a full test is completed (approx. 12 min.).*

The battery test may be optionally disabled – to do so, remove the **BATT. CHECK** jumper. Disabling the test will also deactivate the battery trouble signaling on the AWB output, however it will not disable the circuit protecting the battery from complete discharge.

Note: *Due to the risk associated with a rapid charge equalization when two batteries with a capacity of 17 Ah are connected in parallel, the following rules must be respected:*

- use only two identical batteries (the same manufacturer and type),
- before connection, charge both batteries independently with an external charging device until the final voltage is reached, according to the given type of battery,
- if the battery replacement is necessary, replace both batteries at the same time, making sure that the abovementioned rules are complied with.

11. Switch on 230 V AC power supply (if all connections have been made properly, the LEDs  [MAINS] and  [BATTERY] should come on, while the LEDs  [OVERLOAD] and  [TEMPERATURE] should remain off).

12. Then, you can check the trouble control circuits for proper functioning (with BATT. CHECK jumper on):

Disconnect mains supply – the  [MAINS] LED will go out and the APS-1012 will start audibly signaling the trouble. After the time set on the pins has elapsed, the AWS output status will change. After restoring the mains, the LED will come on with steady light, the

sound will be muted, and – after expiry of the time set on the pins – the AWS output will stop signaling trouble.

Disconnect battery – after approx. 12 minutes the green [BATTERY] LED will go out and the APS-1012 will start audibly signaling the trouble. The AWB output will signal emergency condition. Reconnecting the battery will stop the trouble signaling by the LED indicator and buzzer after approx. 12 minutes. When the APS-1012 has been installed and tested for operation, its housing can be closed.

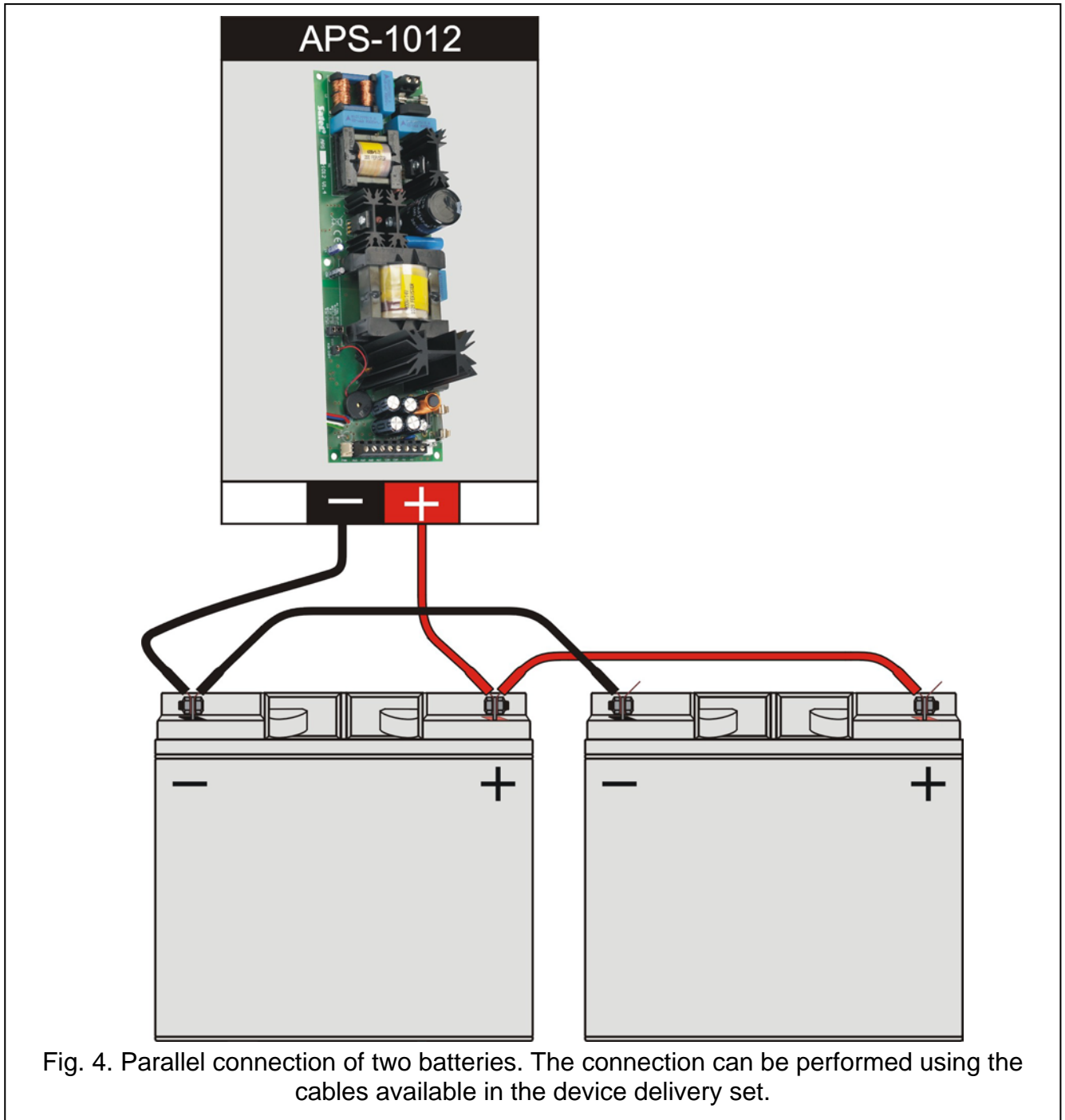

Fig. 4. Parallel connection of two batteries. The connection can be performed using the cables available in the device delivery set.



As the APS-1012 has no isolating switch to disconnect the mains supply, it is important that the user/owner of the device be advised on how it should be disconnected from the mains (e.g. by indicating the fuse which protects the supply circuit on the electric switchgear).

3. Specifications

Type of power supply unit	A
Supply voltage	230 V AC
Rated output voltage.....	12 V DC
Current capacity.....	10 A
Maximum battery charging current (switchable)	2 A or 4 A
Energy efficiency	up to 84%
Recommended battery	2 x 12 V/17 Ah
Load-carrying capacity, outputs: AWS, AWB, AWP, AWT (OC type)	max. 50 mA
Operating temperature range (Class I)	+5...+45 °C
Electronics board dimensions.....	233 x 73 mm
Housing dimensions	403 x 323 x 100 mm
Weight (without battery).....	3.44 kg

WARNING

This is a Class A device. It may cause radio interference in residential environment. In such cases, the user may be required to apply suitable countermeasures.



The control panel power supply unit has been designed for work with lead batteries or other batteries with a similar charging curve. Using any other batteries than recommended may cause a blow-up.

The batteries, when used-up, must not be thrown away, but disposed of as required by the existing regulations (European Directives 91/157/EEC and 93/86/EEC).

The latest EC declaration of conformity and certificates are available for downloading on our website www.satel.pl

