

Alarm Control Panel

VERSA

Firmware Version 1.09

Satel® 



INSTALLER MANUAL

SATEL sp. z o.o.
ul. Budowlanych 66
80-298 Gdańsk
POLAND
tel. +48 58 320 94 00
www.satel.eu

WARNINGS

The security alarm system should be installed by qualified personnel.

Prior to installation, please read carefully this manual in order to avoid mistakes that can lead to malfunction or even damage to the equipment.

Disconnect power before making any electrical connections.

Changes, modifications or repairs not authorized by the manufacturer shall void your rights under the warranty.

SATEL's goal is to continually upgrade the quality of its products, which may result in some changes of their technical specifications and firmware. The current information on the introduced modifications is available on our website.

Please visit us:
<http://www.satel.eu>

The declaration of conformity may be consulted at www.satel.eu/ce

The following symbols may be used in this manual:



- note,



- caution.

Changes made to the firmware versions 1.08 and 1.09

Global parameters	New option: BACKLIGHT OFF ON AC LOSS.
Partitions	New option: ENTRY DELAY IN NIGHT ARM.
Ethernet module	Changed names of options: <ul style="list-style-type: none">– SATEL SERVER (LAN) has been replaced with LAN,– GET DATE AND TIME FROM A TIME SERVER (LAN) has been replaced with LAN. New options: <ul style="list-style-type: none">– DO NOT REPORT SATEL SERVER CONNECTION TROUBLE,– ALARM 3 INCORRECT CODES (MOBILE APPLICATION).
ABAX wireless system	If the ACU-120 / ACU-270 controller with firmware version 5.03 is connected to the control panel: <ul style="list-style-type: none">– you can select whether the AMD-101 detector is to occupy one or two positions on the list of wireless devices,– the users can replace batteries in the wireless keypad after starting the REPLACE BAT. function. APT-100 keyfob LEDs can indicate that partitions are disarmed.
E-mail messaging	Changed name of option: E-MAIL MESSAGING (LAN) has been replaced with LAN.
Entering code	After an incorrect code has been entered, the “Wrong code” message will be displayed on the LCD keypad. The same message will also be displayed after entering a correct code, when the keypad is blocked.
User functions	A new function in the 0.SERVICE submenu: 9.REPLACE BAT.

CONTENTS

1. Introduction	4
2. Features	4
3. Keypads	6
3.1 Keypads features.....	6
4. Expansion modules	7
5. System installation	7
5.1 Installation plan.....	7
5.2 Estimation of the system current consumption.....	8
5.3 Cabling.....	8
5.4 Installation of control panel mainboard.....	8
5.4.1 Description of the mainboards.....	9
5.5 Connecting devices to the communication bus.....	11
5.5.1 Connecting hardwired keypads.....	11
5.5.2 Connecting Ethernet module.....	12
5.5.3 Connecting 433 MHz keyfobs receiver expansion module.....	13
5.5.4 Connecting 433 MHz wireless system controller.....	13
5.5.5 Connecting ABAX wireless system controller.....	14
5.5.6 Connecting the hardwired zone expanders.....	15
5.5.7 Connecting the hardwired output expander.....	16
5.5.8 Connecting proximity card arm/disarm devices.....	17
5.5.9 Connecting voice module / voice synthesizer expander.....	18
5.6 Connecting the detectors.....	18
5.6.1 End-of-line resistors.....	19
5.7 Connecting the sirens.....	19
5.8 Connecting the radio monitoring transmitter.....	20
5.9 Connecting the analog telephone line.....	21
5.10 Connecting the power supply and starting the control panel.....	22
5.10.1 Main power supply.....	22
5.10.2 Backup power supply.....	22
5.10.3 Control panel power-up / start-up procedure.....	23
5.10.4 Emergency procedure of the control panel start-up.....	23
5.10.5 First steps after starting-up the control panel.....	24
5.11 Programming addresses for the hardwired keypads.....	24
5.11.1 Programming the address by means of the service function.....	24
5.11.2 Programming the address without entering the service mode.....	25
5.12 Identification of devices connected to the bus.....	25
5.12.1 Starting the identification function from keypad.....	26
5.12.2 Starting the identification function from DLOADX program.....	26
5.13 Connecting the computer to the control panel.....	26
5.14 Installation of ABAX wireless devices.....	26
5.14.1 Adding new ABAX wireless devices.....	27
5.14.2 Removing ABAX wireless devices.....	28
5.15 Installation of 433 MHz wireless detectors.....	29
5.15.1 Adding new 433 MHz wireless detectors.....	29
5.15.2 Removing 433 MHz wireless detectors.....	30
6. Numeration of zones and outputs in the system	30
6.1 Numeration of zones.....	30

6.1.1	Hardwired zones	30
6.1.2	Wireless zones	30
6.2	Numeration of outputs	31
6.2.1	Hardwired outputs	31
6.2.2	Wireless outputs	31
7.	Specifications	31
7.1	Control panel	31
7.2	VERSA-LCD keypad	32
7.3	VERSA-LCDM keypad	32
7.4	VERSA-LCDR keypad	33
7.5	VERSA-LED keypad	33
8.	Manual update history	33

1. Introduction

This manual describes the VERSA 5, VERSA 10 and VERSA 15 control panels and how to install them. In addition, the manual provides information on devices which can be used with the control panels and how they should be connected.

The VERSA series alarm control panels meet the requirements of the following standards: EN 50131-1 Grade 2, EN 50131-3 Grade 2, EN 50131-6 Grade 2, EN 50130-4 and EN 50130-5 Class II.

2. Features

System structure

- 2 partitions (group of zones).
- Each zone can be assigned to two partitions.

Zones

- 5 (VERSA 5), 10 (VERSA 10) or 15 (VERSA 15) programmable hardwired zones on the control panel mainboard:
 - support for NO and NC type detectors, as well as roller shutter and vibration detectors,
 - support for Single EOL and Double EOL configuration.
- Maximum number of programmable zones: 30.
- 20 zone types.
- NC type tamper input on the control panel mainboard.

Outputs

- 4 programmable hardwired outputs on the control panel mainboard:
 - 2 high-current outputs,
 - 2 low-current outputs, OC type.
- Maximum number of programmable outputs: 12.
- 22 performed functions.
- Capability to operate the radio monitoring transmitter using the mainboard low-current outputs (support for PC-16 OUT format).
- 2 power supply outputs on the control panel mainboard.

Communication bus

- Capability to connect keypads and expansion modules.

Communication

- Built-in analog telephone communicator.
- Built-in 300 bps modem.

Reporting

- Reporting events to two monitoring stations:
 - several communication formats (including Contact ID and SIA),
 - 4 identifiers.
- Sending event codes to the monitoring station through:
 - analog telephone network,
 - Ethernet network [requires ETHM-1 / ETHM-1 Plus module to be connected].

Messaging

- Event messaging to 8 phone numbers in the form of:
 - 16 voice messages,
 - 64 text messages.
- Sending event notifications to 8 e-mail addresses using e-mail messages [requires ETHM-1 Plus module to be connected].
- Informing users of the VERSA CONTROL application about events using push notifications [requires ETHM-1 Plus module to be connected].

Remote operation using a telephone [requires INT-VG module to be connected]

- Checking the alarm system status.
- Control of the alarm system.
- Capability to define macrocommands to run a number of different functions, thus facilitating remote control via telephone.
- Voice menu to make operation easier.

VERSA CONTROL mobile application [requires ETHM-1 Plus module to be connected]

- Operating the alarm system from mobile devices:
 - control of the alarm system,
 - checking the alarm system status.

Event log

- 2047 events.

Users

- 30 users.
- Capability to assign to the user:
 - a code,
 - a proximity card (125 kHz passive transponder, which may be in the form of a card, tag, etc.),
 - keyfob.
- Authority level determining the scope of access to the system.

Timers

- 4 timers to automatically:
 - arm/disarm the partitions,
 - control the outputs (switching the lights on/off, watering the garden, etc.).

Programming

- Local programming:
 - keypad,
 - computer with the DLOADX program installed, connected to the control panel RS-232 (TTL) port.
- Remote programming using a computer with DLOADX program installed, via:
 - telephone network (modem),
 - Ethernet network [requires ETHM-1 / ETHM-1 Plus module to be connected].

Mainboard

- RS-232 (TTL) port to allow:
 - local programming by means of a computer with the DLOADX program installed,

- firmware update for the control panel.
- Electrical protection of all hardwired zones and outputs, and communication bus.
- Switching power supply with short-circuit protection, provided with a battery status supervision and low battery disconnect system.

3. Keypads

SATEL offers the following keypads for VERSA alarm control panels:

INT-TSG – hardwired touchscreen keypad,

INT-TSH – hardwired touchscreen keypad,

VERSA-LCD – hardwired LCD keypad with mechanical keys,

VERSA-LCDM – hardwired LCD keypad with mechanical keys,

VERSA-LCDR – hardwired LCD keypad with mechanical keys and built-in proximity card reader,

VERSA-LCDM-WRL – wireless LCD keypad with mechanical keys and built-in proximity card reader (supported by ACU-120 and ACU-270 controllers),

VERSA-LED – hardwired LED keypad with mechanical keys.

The keypads are also available with different color options for display and backlight of keys. The color variant is indicated by the additional designation in the keypad name (e.g. VERSA-LCD-GR – green display and keys backlight; VERSA-LCDM-WH – white display and keys backlight).

i For information on the INT-TSG, INT-TSH and VERSA-LCDM-WRL keypads, please refer to the manuals delivered with the keypads.

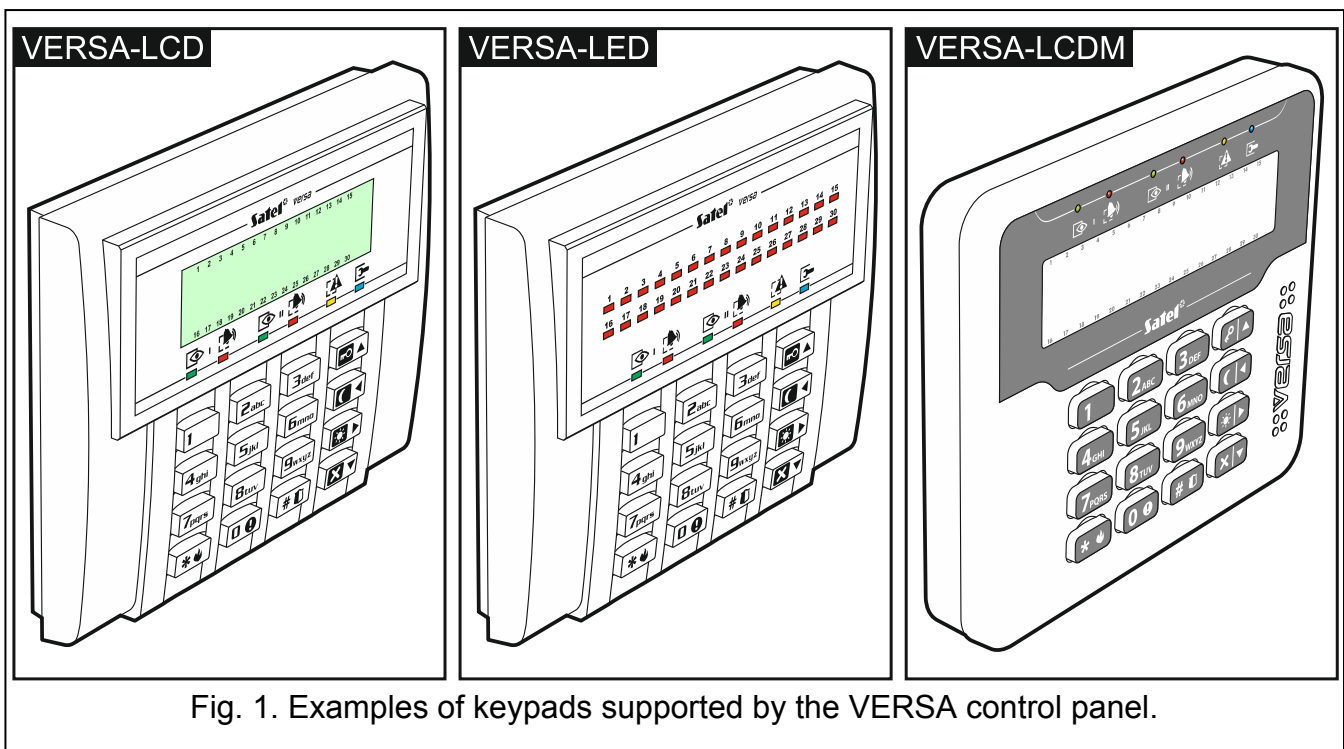

Fig. 1. Examples of keypads supported by the VERSA control panel.

3.1 Keypads features

- Display 2 x 16 characters with backlight. **VERSA-LCD / VERSA-LCDM / VERSA-LCDR**
- LEDs indicating the status of the zones. **VERSA-LED**

- LEDs indicating the status of the partitions and the system.
- 12 keys, bearing designations according to telephone standard and intended for entering data.
- 4 additional keys for menu navigation and arming/disarming.
- Backlit keys.
- Built-in proximity card reader. **VERSA-LCDR**
- Tamper contact reacting to the enclosure opening or detaching from the wall.

4. Expansion modules

ETHM-1 Plus / ETHM-1. Ethernet communication module. Enables reporting events as well as operating and programming the control panel via the Ethernet network.

INT-RX-S / INT-RX. 433 MHz keyfobs receiver expansion module. Enables operation of the alarm system using the 433 MHz keyfobs.

VERSA-MCU. 433 MHz wireless system controller. Enables the alarm system to be operated using the 433 MHz keyfobs and the 433 MHz wireless detectors to be used in the alarm system.

ACU-120 / ACU-270 / ACU-100 / ACU-250. ABAX wireless system controller. Enables the alarm system to be operated using the ABAX keyfobs and the ABAX bidirectional wireless devices to be used in the alarm system.

INT-E / CA-64 E / CA-64 EPS. Zone expander. Adds 8 programmable hardwired zones to the security system.

INT-O / INT-ORS / CA-64 O / CA-64 OPS. Output expander. Adds 8 programmable hardwired outputs to the security system.

INT-CR / INT-IT-2 / INT-IT. Proximity card arm/disarm device. Enables arming / disarming and alarm clearing in partitions by means of proximity cards, proximity tags and other passive transponders.

CA-64 SM. Voice synthesizer expander. It can store 16 voice messages for telephone messaging.

INT-VG. Voice module. Allows remote operation of the control panel from the telephone keypad (interactive voice menu). It can store 16 voice messages for telephone messaging.

5. System installation



Disconnect power before making any electrical connections.

The following tools will be useful during installation:

- blade screwdriver 2.5 mm,
- Phillips screwdriver,
- precision pliers,
- flat nose pliers,
- drill with a set of drill bits.

5.1 Installation plan

The installation must be preceded by preparation of a plan of the security alarm system. It is advisable to draw up a sketch of the premises and mark on it all the devices that are to be

included in the alarm system: control panel, keypads, detectors, sirens, expansion modules etc. The control panel and other alarm system components should be installed within the protected area.

5.2 Estimation of the system current consumption

At the security system planning stage you should sum up the currents consumed by all devices included in the system (control panel mainboard, keypads, additional modules, detectors, sirens, etc.). The calculation should take into account the battery charging current. If the sum of currents exceeds the maximum output current of the control panel power supply, expander with power supply or an additional power supply unit should be used.

The sum of currents consumed by the devices connected to the power supply unit (expander with power supply) must not exceed the power supply output current.

If you plan to connect devices to particular power outputs (of the control panel, expander with power supply, etc.), remember that the sum of currents consumed by these devices must not exceed the maximum current carrying capacity of those outputs.

5.3 Cabling

It is recommended that an unshielded non-twisted cable be used for making electric connections between devices included in the system.



If you use the twisted-pair type of cable, remember that CLK (clock) and DTA (data) signals must not be sent through one pair of twisted conductors.

Select cross-section of the power supply wires so that the supply voltage drop between the power supply and the supplied device should not exceed 1 V as against the output voltage.

In order to guarantee correct functioning of the system components it is important that resistance and capacitance of the signal wires be as low as possible. When the distances between the devices are greater, several wires connected in parallel may have to be used for each signal, in order to reduce conductor resistance. This, however, may lead in consequence to an increase in conductor capacitance. Too high resistance or capacitance of the cables connecting the control panel to keypads or expansion modules can prevent the devices from working correctly (e.g. the control panel will be unable to identify devices, absence of devices will be reported, etc.). When selecting the length of cables, follow recommendations set out in sections on connection of particular types of devices.

Avoid running the cables in parallel to or in close vicinity of the 230 V AC wires, as this may result in malfunctioning of the system.

5.4 Installation of control panel mainboard



The control panel mainboard contains electronic components sensitive to electric charges.

Before connecting the mainboard to power supply source (battery, alternating voltage from transformer), you must first complete all the installation work with hardwired devices (connection of keypads, expansion modules, detectors etc.).

The control panel should be installed indoors, in spaces with normal humidity of air. The control panel must be protected against unauthorized access. The installer should provide protection for the users and service personnel by using a suitable device enclosure.

A 230 V AC power supply circuit with protective grounding must be available at the control panel installation place.

5.4.1 Description of the mainboards

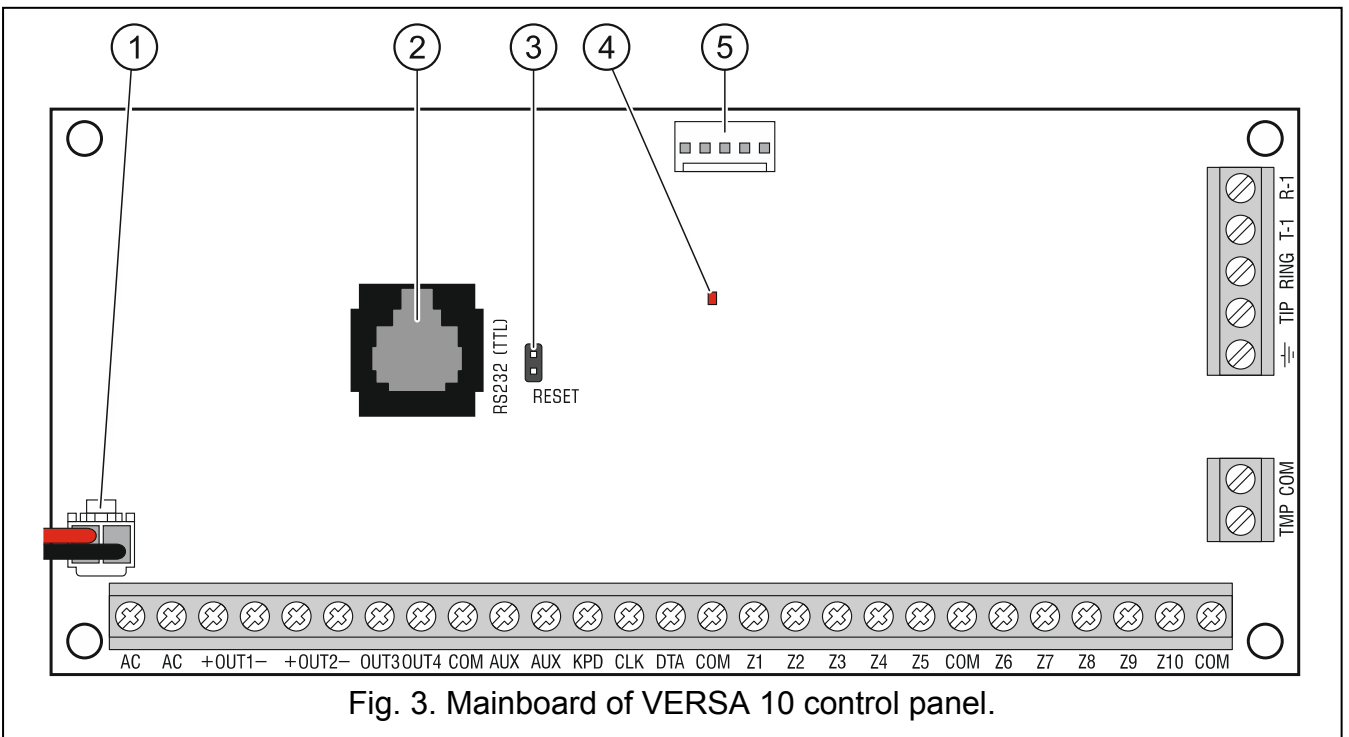
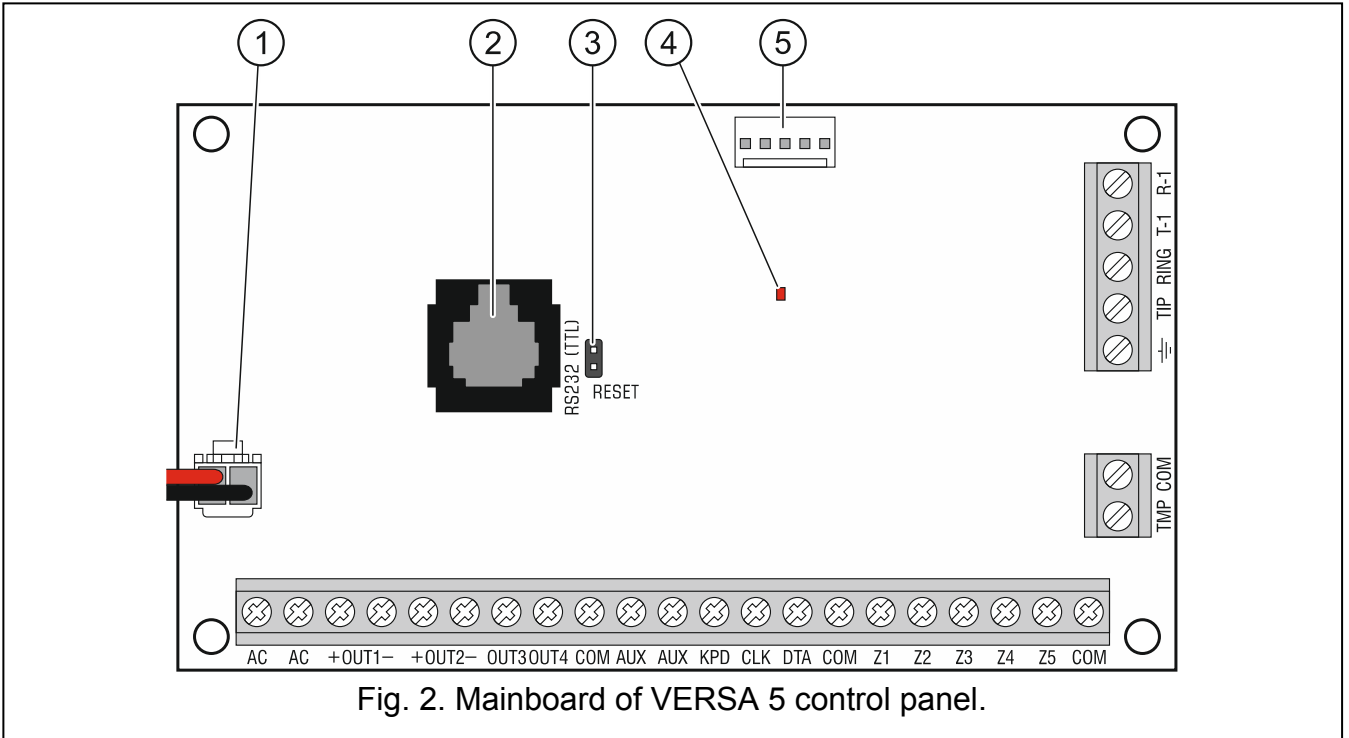

- ① battery connection cables (red +, black -).
- ② RS-232 (TTL) port.
- ③ RESET pins for emergency starting the control panel (see: “Emergency procedure of the control panel start-up” p. 23).
- ④ DIALER LED. Indicates the status of control panel telephone communicator.
- ⑤ socket for connecting the INT-VG voice module, CA-64 SM voice synthesizer expander or SM-2 synthesizer.

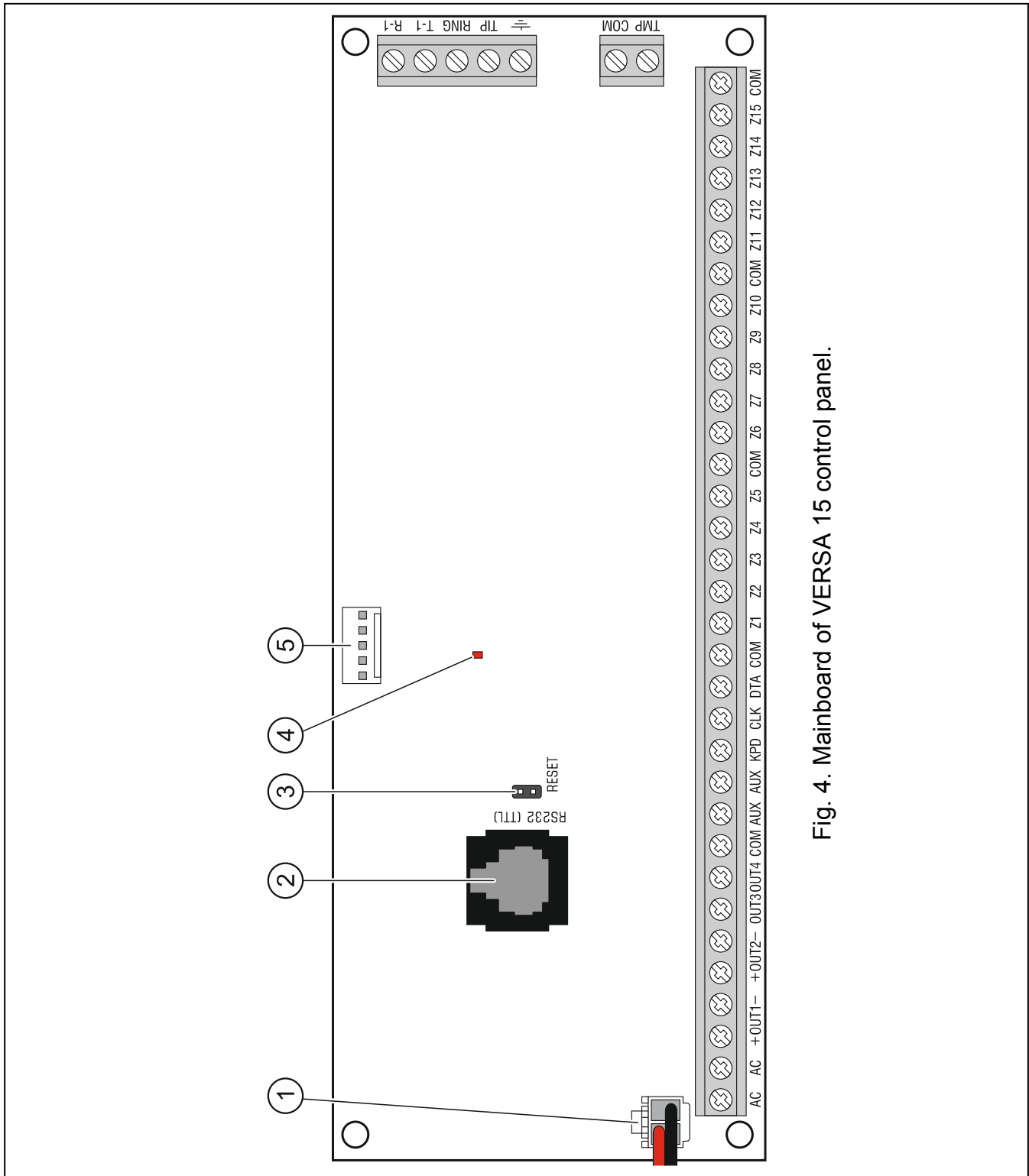



Fig. 4. Mainboard of VERSA 15 control panel.

Description of terminals:

- AC** - power input (18 V AC).
- COM** - common ground.
- +OUT1-, +OUT2-** - programmable high-current outputs. +12 V DC voltage is always present at the “+” terminal. The “-” terminal is either shorted to or disconnected from the common ground, depending on the output status (active/inactive) and polarity.
- OUT3, OUT4** - programmable low-current outputs, OC type.
- AUX** - +12 V DC power output.

KPD	- +12 V DC power output.
CLK	- communication bus clock.
DTA	- communication bus data.
Z1...Z4	- zones.
TMP	- tamper input (NC) – if not used, it should be shorted to the common ground. The TMP input has number 31 in the system.
	- protective terminal of telephone communicator (to be connected only to the PE protective earth circuit of 230 V AC mains).
T-1, R-1	- telephone line output (to premise telephones).
TIP, RING	- telephone line input (from telephone provider).

5.5 Connecting devices to the communication bus



The bus wires must be run in one cable.

The total length of the expander bus may not exceed 600 m.

The device can be powered directly from the control panel, if the distance to the control panel does not exceed 300 m. Where the distance is greater, another power source must be provided for the device (power supply or expander with power supply).

The Table 1 shows the number of wires required for correct connection of the device to the expander bus if conductors with 0.5 mm diameter are used.

Distance	CLK	DTA	COM
	Number of wires		
up to 300 m	1	1	1
300-600 m	2	2	2

Table 1.

For most devices to be connected to the communication bus, setting of a suitable address is required. Two devices must not share the same address (otherwise their identification will be impossible). For information on the requirements related to address setting, please refer to the sections describing how specific devices are to be connected.

5.5.1 Connecting hardwired keypads



To meet the EN 50131 standard requirements for Grade 2:

- keypads with firmware version 1.01 or newer must be connected to the control panel,*
- at least one LCD keypad must be connected to the control panel.*

This will allow the users to be informed about the system state, as required by the standard.

The control panel supports up to 6 wired and wireless keypads. Addresses of the keypads must be set within a range from 0 to 5. Description of programming keypad addresses – see p. 24.



If the ETHM-1 / ETHM-1 Plus module is connected to the control panel (address 4), the control panel can support up to 5 keypads.

Mounting the keypad

The keypads are designed for indoor installation. The place of installation should be readily accessible to the system users.

1. Open the keypad enclosure.
2. Put the enclosure base on the wall and mark the location of mounting holes.
3. Drill the holes for wall plugs (screw anchors).
4. Run wires through the opening in the enclosure base.
5. Using wall plugs (screw anchors) and screws, fasten the enclosure base to the wall.
6. Connect the keypad terminals to the corresponding terminals of the control panel (see: Fig. 5).
7. Close the keypad enclosure.

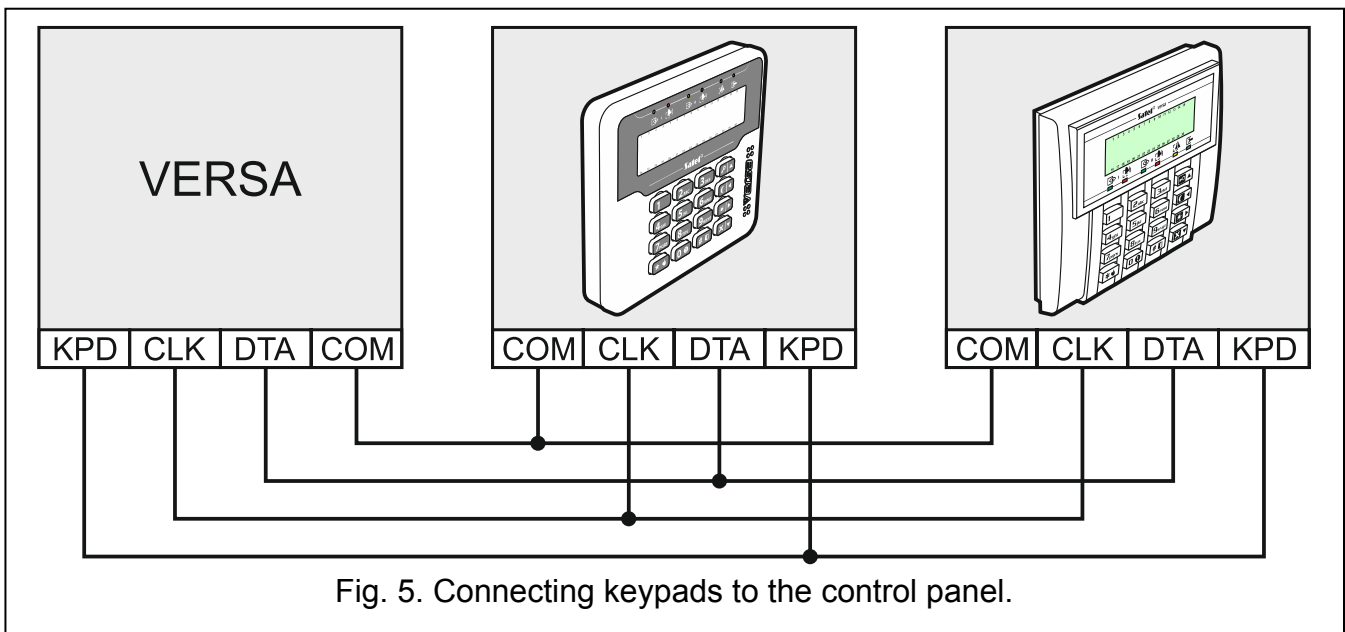

5.5.2 Connecting Ethernet module

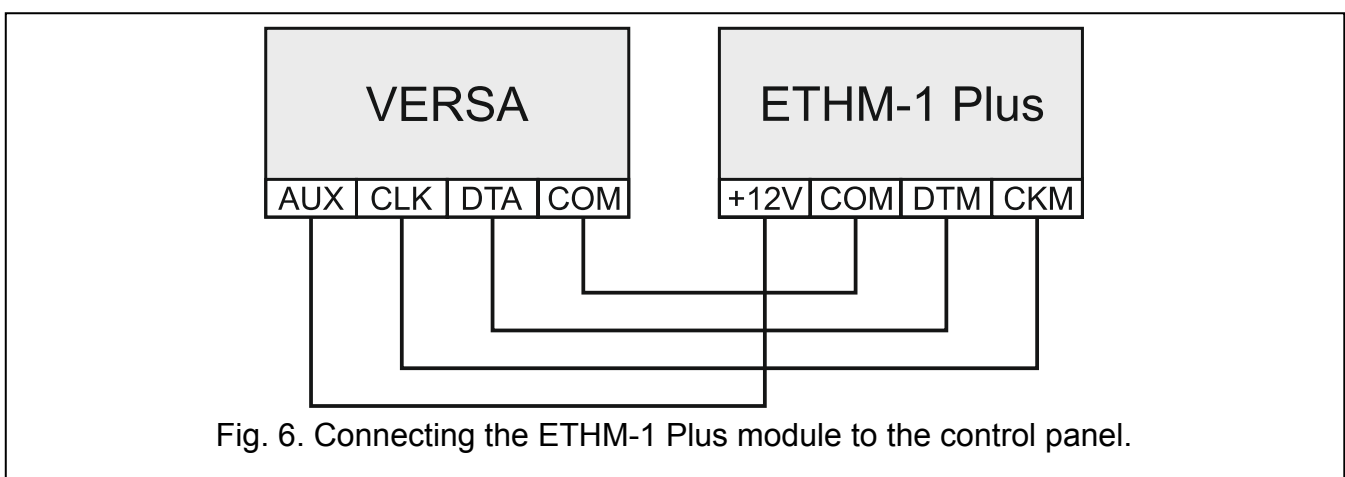

One ETHM-1 Plus or ETHM-1 module can be connected to the control panel. It allows reporting of events and programming of the control panel via the Ethernet network. Additionally, the ETHM-1 Plus module makes possible notification of events by means of e-mail messages as well as operation of the alarm system from mobile devices by means of VERSA CONTROL application.

Address 4 (04h) must be set in the Ethernet module.

i If the Ethernet module is connected to the control panel, the keypad with address 4 cannot be installed in the system.

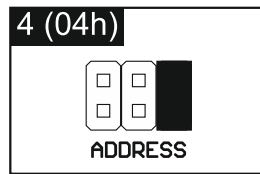

Fig. 7. Setting address in the ETHM-1 Plus module (■ - jumper on; □ - jumper off).

5.5.3 Connecting 433 MHz keyfobs receiver expansion module

One INT-RX-S or INT-RX expansion module can be connected to the control panel. The module enables 433 MHz keyfobs to be assigned to the users (up to 30 keyfobs). Address 7 (07h) must be set in the module.

i If the INT-RX / INT-RX-S expansion module is connected to the control panel, installation of the VERSA-MCU controller in the system is impossible.

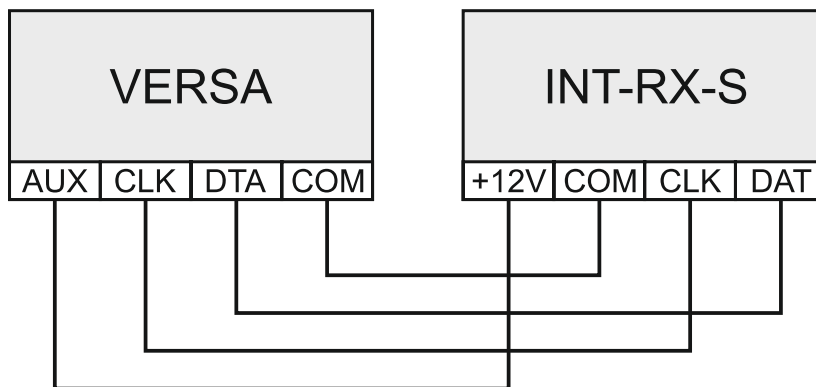

Fig. 8. Connecting the INT-RX-S expander to the control panel.



Fig. 9. Setting address in the INT-RX-S / INT-RX expander.

5.5.4 Connecting 433 MHz wireless system controller

One VERSA-MCU controller can be connected to the control panel. The controller enables 433 MHz keyfobs to be assigned to the users (up to 30 keyfobs). It also enables up to 30 433 MHz wireless detectors to be installed in the alarm system (the control panel can support up to 30 wireless zones). If the wireless zone number coincides with that of the wired zone (on mainboard or in expander), you can select which zone is to be supported (see: PROGRAMMING manual). The controller DIP-switches are not used.

i The VERSA-MCU controller is identified by the control panel as two devices: INT-RX (address 7) and VERSA-MCU (address 8).

If the VERSA-MCU controller is connected to the control panel, installation of the INT-RX-S / INT-RX expansion module and the ACU-120 / ACU-270 / ACU-100 / ACU-250 controller in the system is impossible.

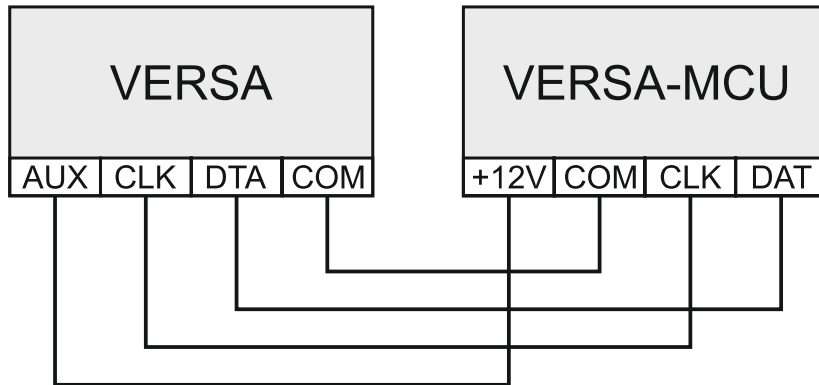

Fig. 10. Connecting the VERSA-MCU controller to the control panel.

5.5.5 Connecting ABAX wireless system controller

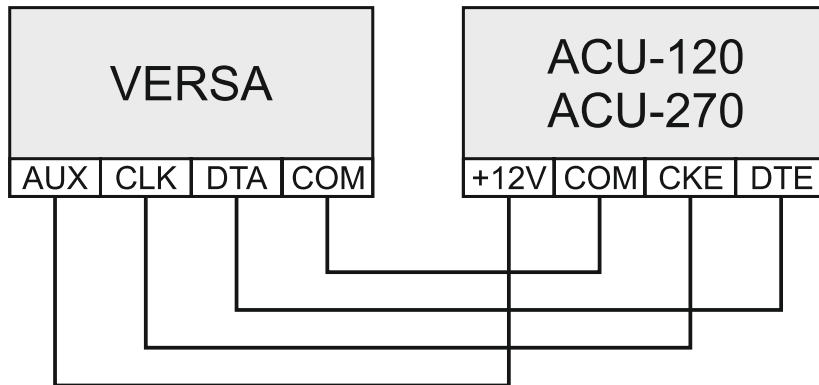

Fig. 11. Connecting the ACU-120 / ACU-270 controller to the control panel.

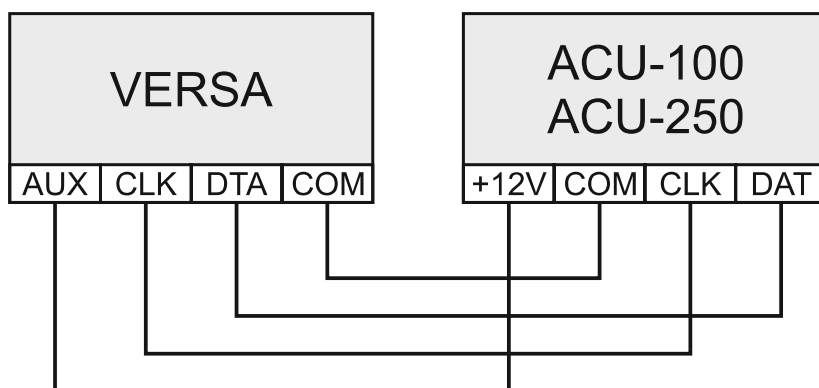

Fig. 12. Connecting the ACU-100 / ACU-250 controller to the control panel.

One ACU-120 / ACU-270 / ACU-100 / ACU-250 controller can be connected to the control panel. The controller enables ABAX keyfobs to be assigned to the users (up to 30 keyfobs). It also enables up to 30 ABAX wireless devices to be installed in the alarm system (the control panel can support up to 30 wireless zones and 12 wireless outputs). If the wireless zone number coincides with that of the wired zone (on mainboard or in expander), you can select which zone is to be supported (see: PROGRAMMING manual). The ACU-120 / ACU-270 controller enables the VERSA-LCDM-WRL wireless keypads to be used in the system.

Depending on the controller, set the DIP-switches as required:

ACU-120 / ACU-270: switch 8 to ON position, the status of the other switches being irrelevant,

ACU-100: switches 4, 7 and 8 to ON position, and the other ones to OFF position (address 8 (08h) and the VERSA control panel compatibility mode enabled),

ACU-250: switch 4 to ON position, and the other ones to OFF position (address 8 (08h)).



All controllers of the ABAX wireless system are identified by the control panel as the ACU-100 controller.

If the ACU-120 / ACU-270 / ACU-100 / ACU-250 controller is connected to the control panel, installation of the VERSA-MCU controller in the system is impossible.

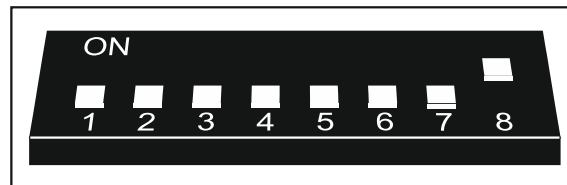

Fig. 13. Setting the DIP-switches in the ACU-120 / ACU-270 controller.

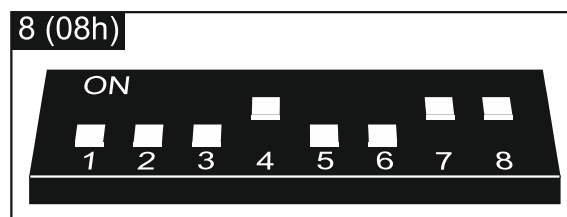

Fig. 14. Setting the DIP-switches in the ACU-100 controller.

5.5.6 Connecting the hardwired zone expanders

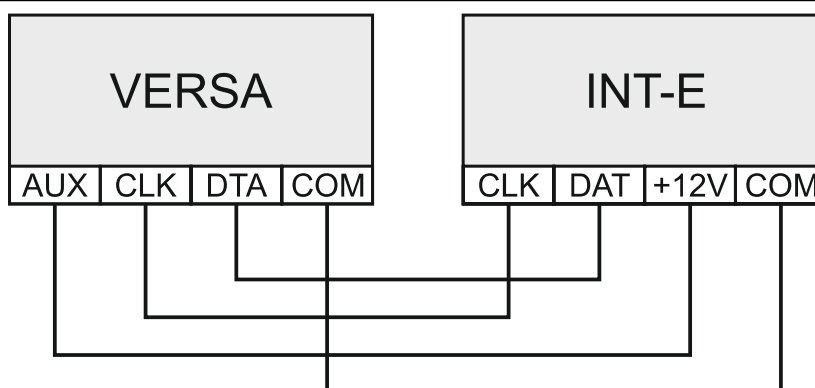

Fig. 15. Connecting the INT-E expander to the control panel.

Up to three INT-E / CA-64 E / CA-64 EPS expanders can be connected to the control panel. This enables expansion of the system by adding up to 24 programmable wired zones. Using the expander DIP-switches:

- set an address within the range from 12 (0Ch) to 14 (0Eh) – switches 1-5,
- define how the expander is to be identified – switch 10 (INT-E) or 8 (CA-64 E / CA-64 EPS).

For detailed information on how the expander will be identified and what are the functional differences resulting from the identification, please refer to the manual delivered with the expander.

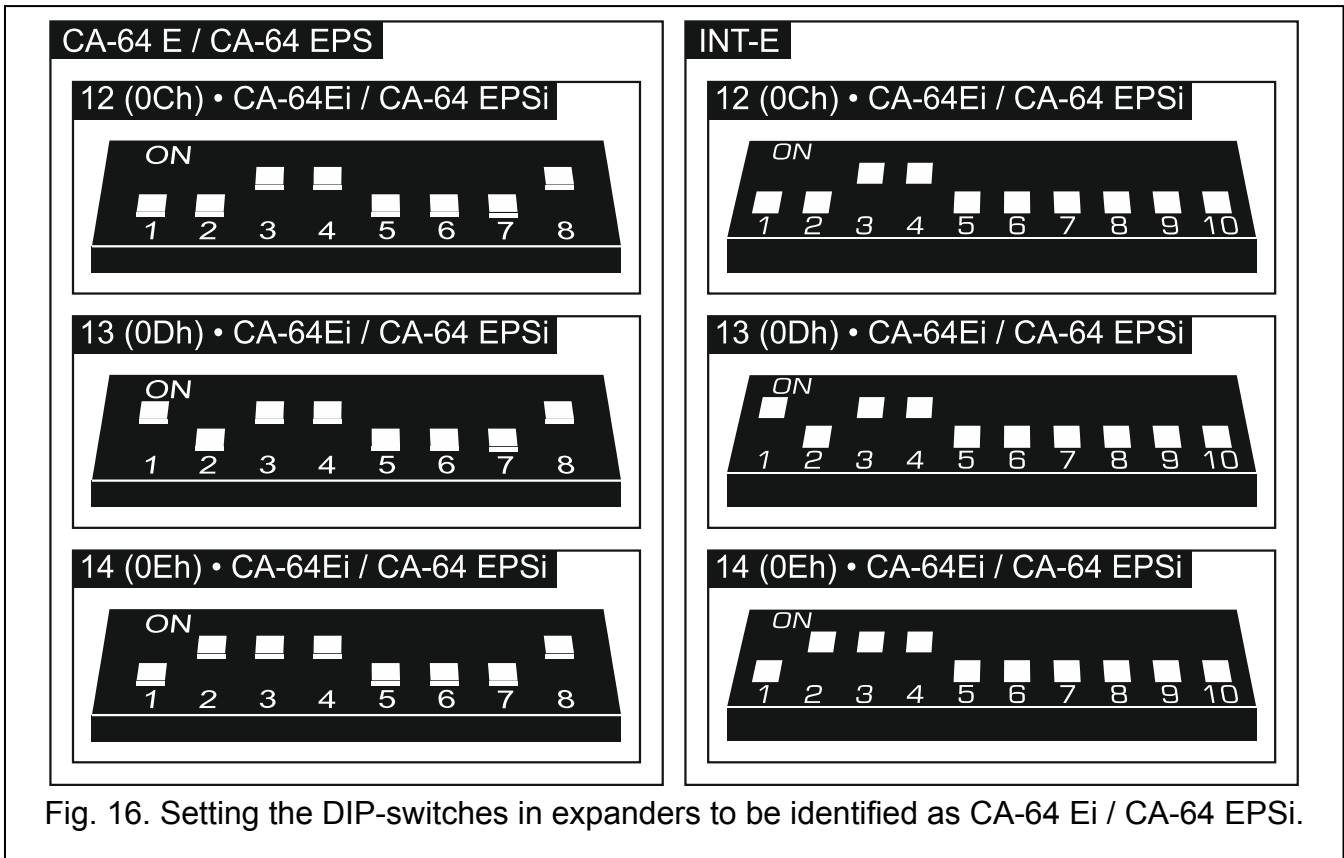

Fig. 16. Setting the DIP-switches in expanders to be identified as CA-64 Ei / CA-64 EPSi.

Table 2 shows numbering of the expander zones depending on the address set. If a number of expander zone coincides with a number of mainboard zone or a number of wireless zone, you can select which zone is to be supported (see: PROGRAMMING manual).

Expander address		Zone numbers
decimally	hexadecimally	
12	0C	7-14
13	0D	15-22
14	0E	23-30

Table 2.

5.5.7 Connecting the hardwired output expander

One INT-O / INT-ORS / CA-64 O / CA-64 OPS expander can be connected to the control panel. This enables expansion of the system by adding 8 programmable wired outputs. Address 15 (0Fh) must be set in the expander. In the case of the INT-ORS expander, you must also use the DIP-switches to define how the expander is to be identified (for detailed information please refer to the manual delivered with the expander).

i The INT-O expander is identified as CA-64 O (the dedicated power supply not connected to the expander) or CA-64 OPS (the dedicated power supply connected to the expander).

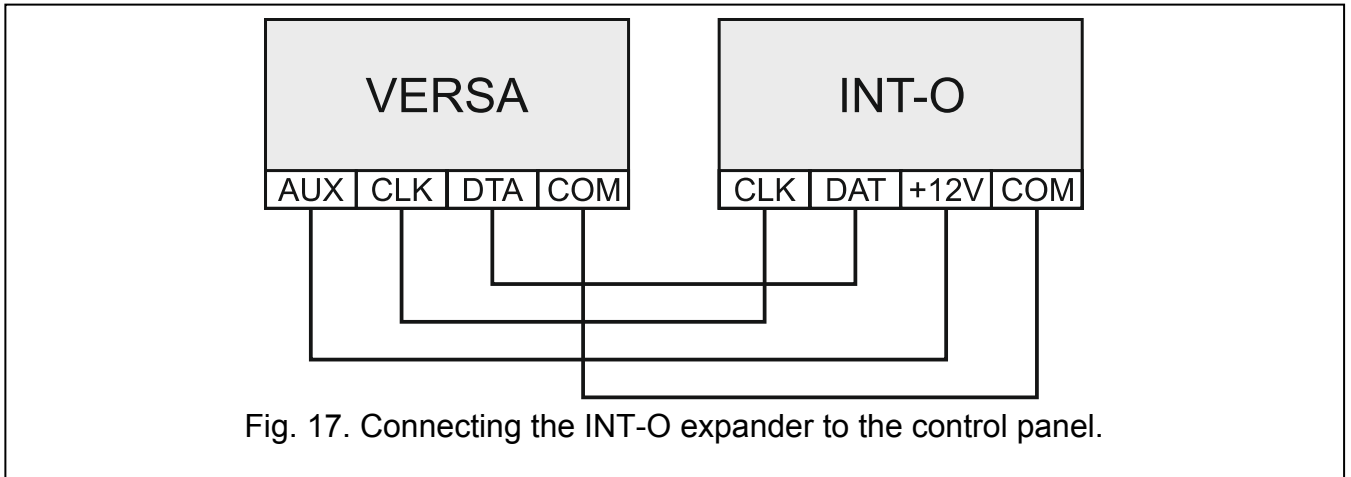

Fig. 17. Connecting the INT-O expander to the control panel.

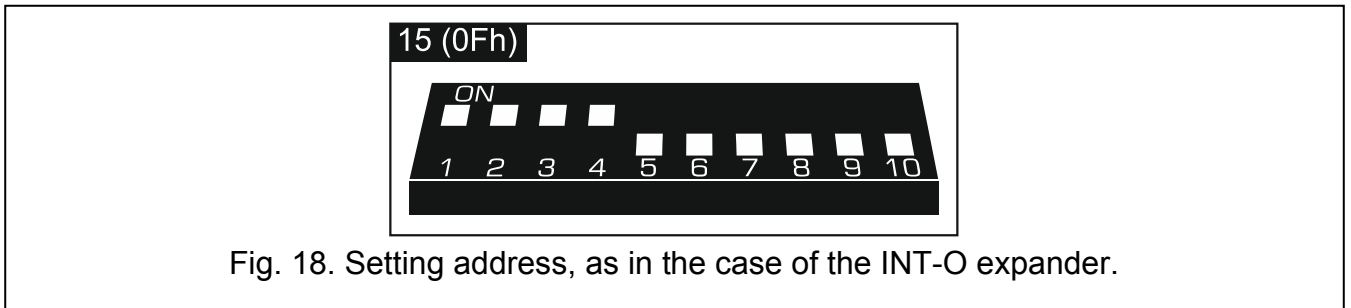

Fig. 18. Setting address, as in the case of the INT-O expander.

5.5.8 Connecting proximity card arm/disarm devices

Up to 6 INT-CR / INT-IT / INT-IT-2 devices can be installed in the system. Addresses from the 16 (10h) to 21 (15h) range should be set in the devices.



All the proximity card arm/disarm devices are identified by the control panel as the INT-IT module.

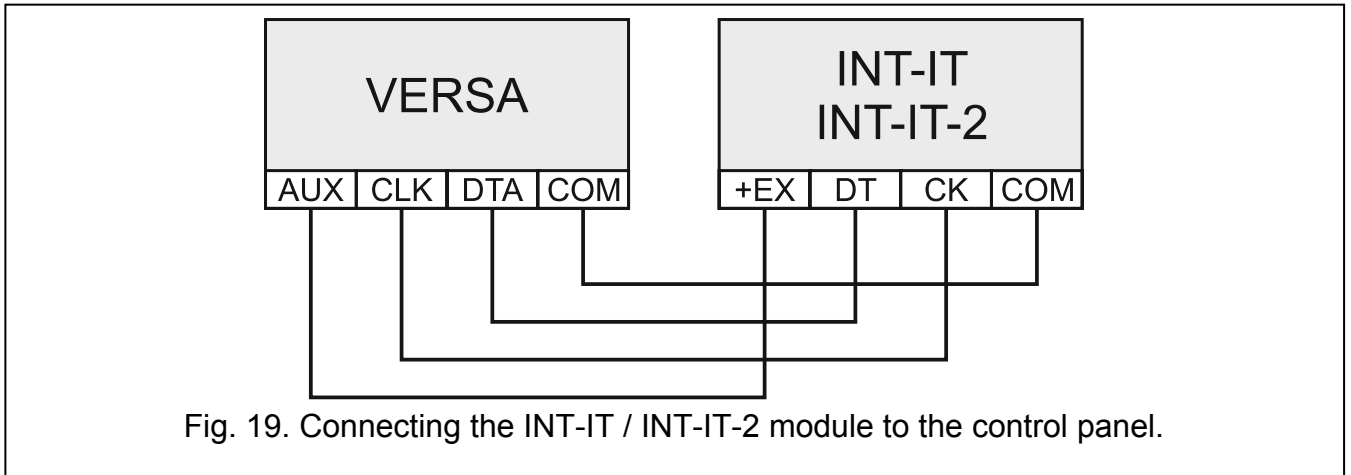

Fig. 19. Connecting the INT-IT / INT-IT-2 module to the control panel.

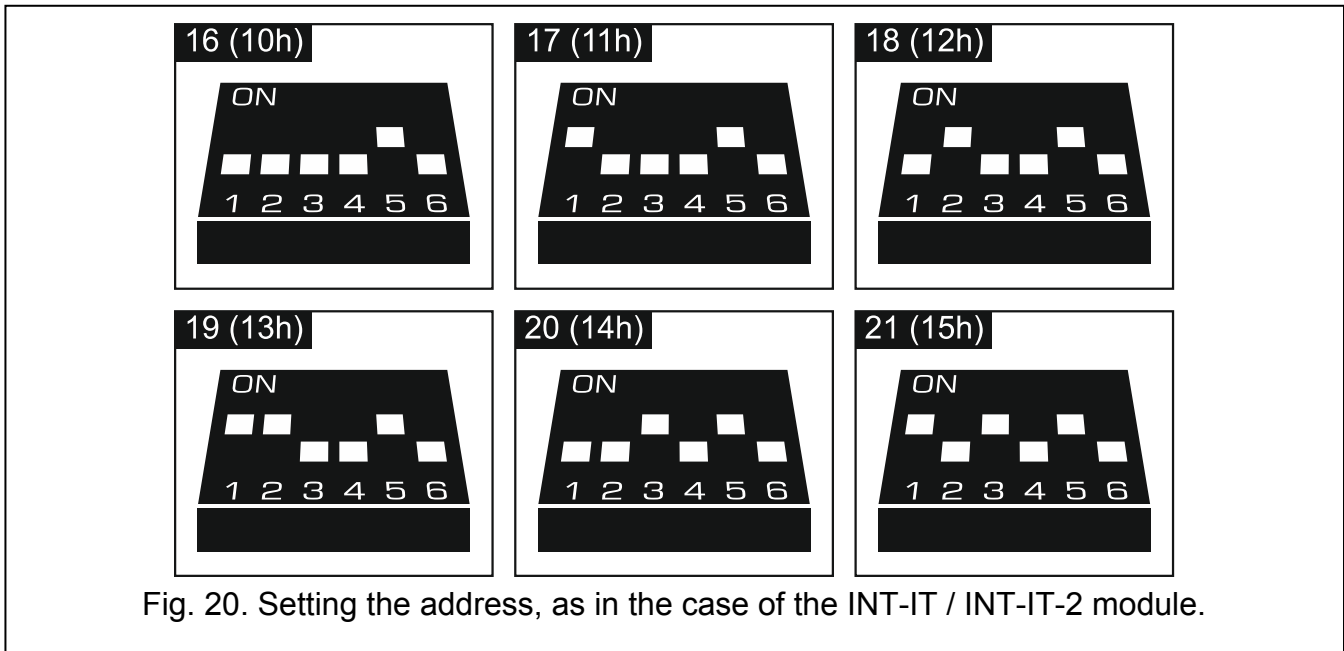

Fig. 20. Setting the address, as in the case of the INT-IT / INT-IT-2 module.

5.5.9 Connecting voice module / voice synthesizer expander

One INT-VG module / CA-64 SM expander can be connected to the control panel. It allows recording of voice messages that will be used for telephone notification of events. In addition, the INT-VG module offers the ability to operate the control panel from the telephone keypad (interactive voice menu).

Address 23 (17h) must be set in the module / expander. The switch 7 in INT-VG module is used to define how the device is to be identified by the control panel (OFF – INT-VG; ON – CA-64 SM). The switch 8 disables / enables the recording of messages by means of built-in microphone in both devices.

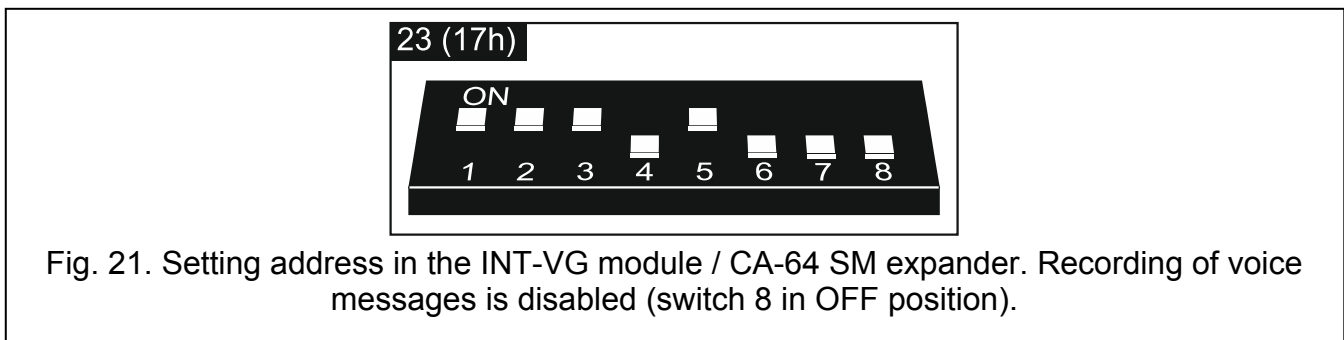

Fig. 21. Setting address in the INT-VG module / CA-64 SM expander. Recording of voice messages is disabled (switch 8 in OFF position).

Connect the CLK and DTA terminals (INT-VG) / wires (CA-64 SM) to the communication bus of the alarm control panel, and the plug to the dedicated socket.

5.6 Connecting the detectors

How the detector is connected to the zone must be suitable for the configuration chosen for that zone. The zones on the control panel mainboard support the following configurations:

- NC** – the wiring type dedicated to connecting devices with the NC (normally closed) alarm output. Opening the circuit will trigger an alarm.
- NO** – the wiring type dedicated to connecting devices with the NO (normally open) alarm output. Closing the circuit will trigger an alarm.
- EOL** – this wiring type may be used to connect devices having the NC or NO alarm output. Closing or opening the circuit will trigger an alarm.

2EOL/NC – the wiring type recommended to connect detectors having the NC alarm output and a tamper output. The zone can recognize 3 states: normal, alarm and tamper.

2EOL/NO – the wiring type similar as 2EOL/NC, but for detectors with the NO alarm output.

Roller – the wiring type dedicated to connecting roller shutter detectors.

Vibration – the wiring type dedicated to connecting vibration detectors. The zone will also accept connection of a detector with the NC alarm output (e.g. a vibration detector and a magnetic contact can be connected in series).

- i** | The *ROLLER* and *VIBRATION* wiring types are supported by:
- all zones on the mainboard of *VERSA 5* control panel,
 - zones from 1 to 8 on the mainboard of *VERSA 10* or *VERSA 15* control panel.

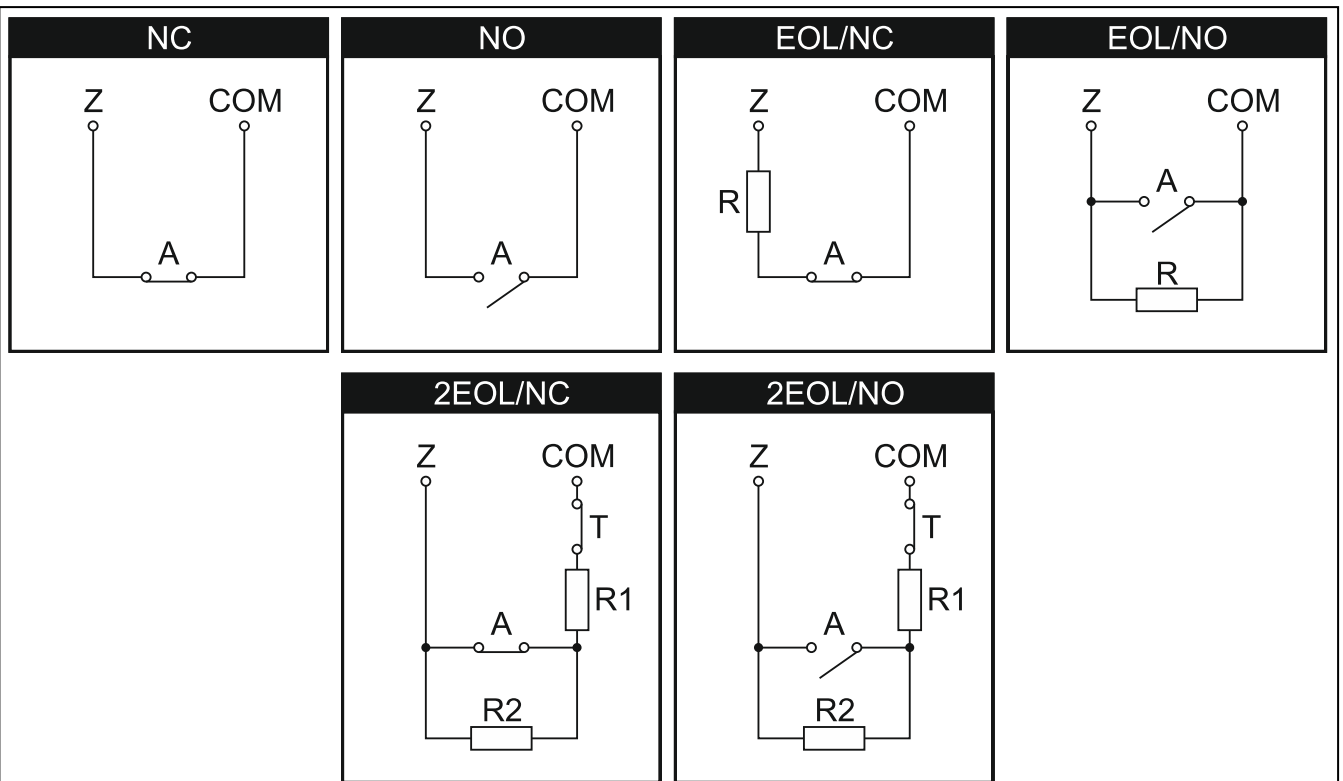

Fig. 22. The ways to connect detectors to zones. The detector outputs are designated with letters: A - alarm, T – tamper. $R=R1+R2$.

5.6.1 End-of-line resistors

For the zones on the control panel mainboard and in the expanders identified by the control panel as CA-64 Ei and CA-64 EPSi, the EOL resistor value is programmable within the range from 500 Ω to 15 kΩ (the sum of programmable values must not exceed 15 kΩ – see the PROGRAMMING manual).

- i** | If the resistor value in the expander is not programmable, in Single EOL configuration, the 2.2 kΩ resistor is required, and in Double EOL (2EOL) configuration – two 1.1 kΩ resistors.

5.7 Connecting the sirens

- i** | It is recommended that the control panel be started without connected sirens. This will prevent accidental triggering of the alarm after the control panel is started.

Depending on the siren type:

- sirens without own power supply (e.g. SP-500, SP-4001, SP-4003, SPL-2010, SPW-100, SPW-210, SPW-220) – high-current outputs are to be used to trigger the signaling,
- sirens with own power supply (e.g. SP-4002, SP-4004, SP-4006, SP-6500, SPLZ-1011, SD-3001, SD-6000) – it is recommended to use low-current outputs to trigger the signaling, and high-current ones – to supply power.

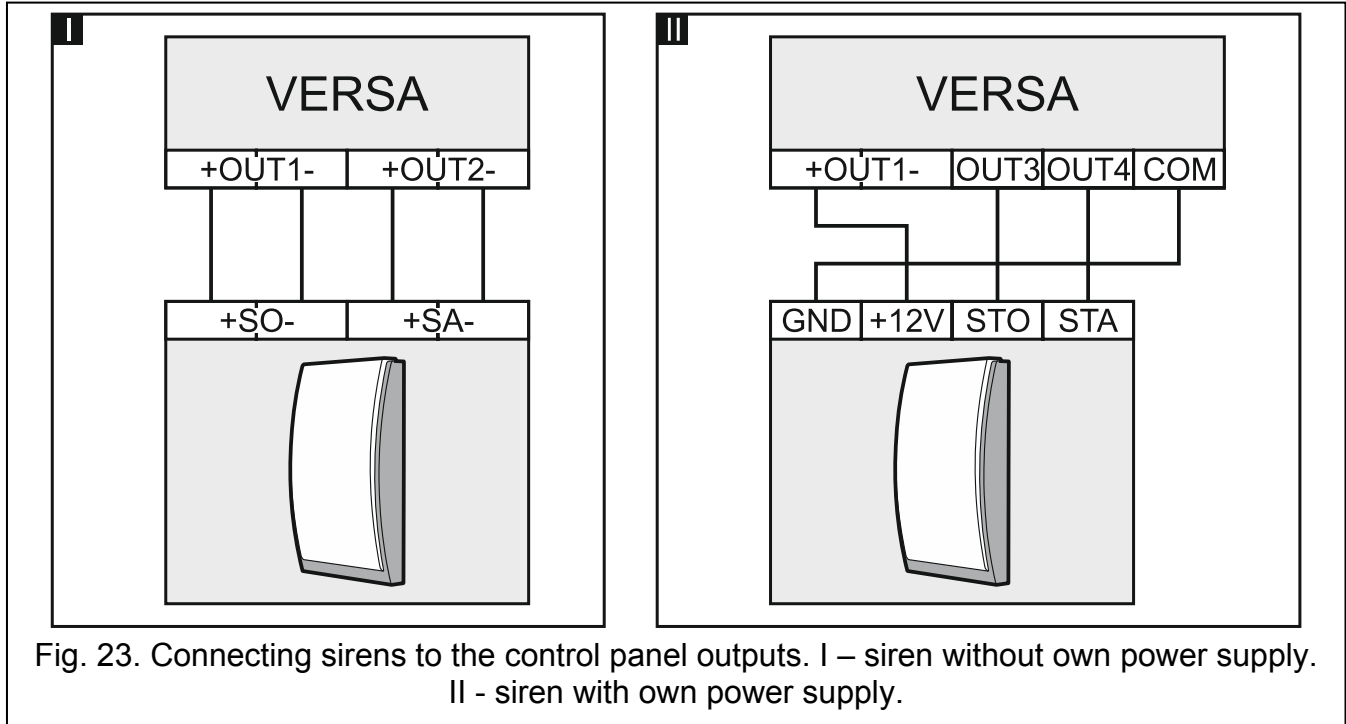

5.8 Connecting the radio monitoring transmitter

The OUT3 and OUT4 outputs of the control panel can be used for control of the NR2-DSC radio monitoring transmitter (NEMROD system – format PC-16 OUT) manufactured by NOKTON. In such a case, the SERIAL DATA ON OUT 3/4 global option must be enabled in the control panel (see PROGRAMMING manual). Table 3 contains description of the connector contacts in the NOKTON NR2-DSC transmitter, used for connecting to the VERSA control panel.

Contact number	Description	Connection method
2	alternating voltage check	connect to control panel AC terminal
12	power supply	connect directly to battery “+” through 2 A fuse
13	common ground	connect to control panel COM terminal
14	TAKT	connect to control panel OUT3 terminal
15	PGM	connect to control panel OUT4 terminal

Table 3.



Never connect the contact 13 (common ground) of the NR2-DSC transmitter connector to the battery “-”. Connecting the transmitter common ground to the battery “-” may not only cause quick discharge of the battery, but even damage to the control panel.

Never connect the contact 13 (common ground) of the NR2-DSC transmitter connector to the control panel COM terminal and the battery “-”, as it may cause damage to the control panel.

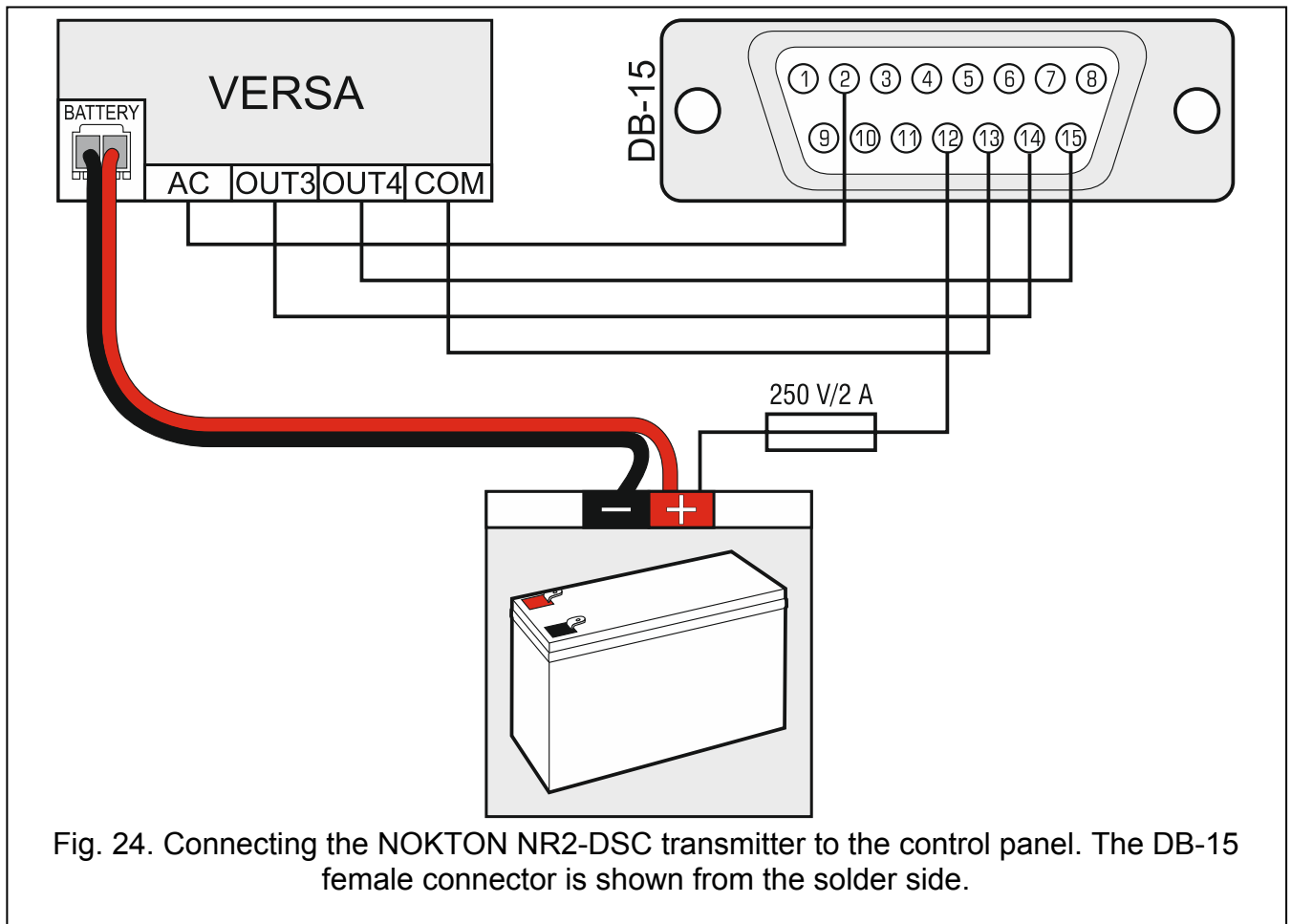

Fig. 24. Connecting the NOKTON NR2-DSC transmitter to the control panel. The DB-15 female connector is shown from the solder side.

5.9 Connecting the analog telephone line



Do not send telephone signals and alarm system signals by one multicore cable. This may cause damage to the system in case of a high-voltage punch-through coming from the telephone.

The control panel may only be connected to analog PSTN lines.

The system installer should inform the user about the way of connecting the control panel to the telephone network.

The control panel must be connected directly to the telephone line (terminals marked TIP, RING). Other devices using the telephone line (e.g. telephone, fax) should be connected after the control panel (terminals marked T-1, R-1). Hence the telephone line should be connected to the control panel using a four-wire cable. When connected in this manner, the control panel will be able to completely capture the line for the time of making a call. This will prevent the control panel telephone dialer from being blocked, e.g. by lifting the telephone receiver (such a situation would take place, if the control panel was connected to the telephone line after the telephone set).

If the ADSL service is used on the premises where the control panel is installed, the control panel should be connected after the ADSL filter, and the other devices using the analog telephone line should be connected to the control panel.

To protect the telephone communicator against over-voltage, connect the \perp terminal to the protective earth conductor (PE) of the 230 V AC mains. To make the connection, use a conductor with $\geq 0,75 \text{ mm}^2$ cross-section. Never connect the \perp terminal to the neutral conductor (N).

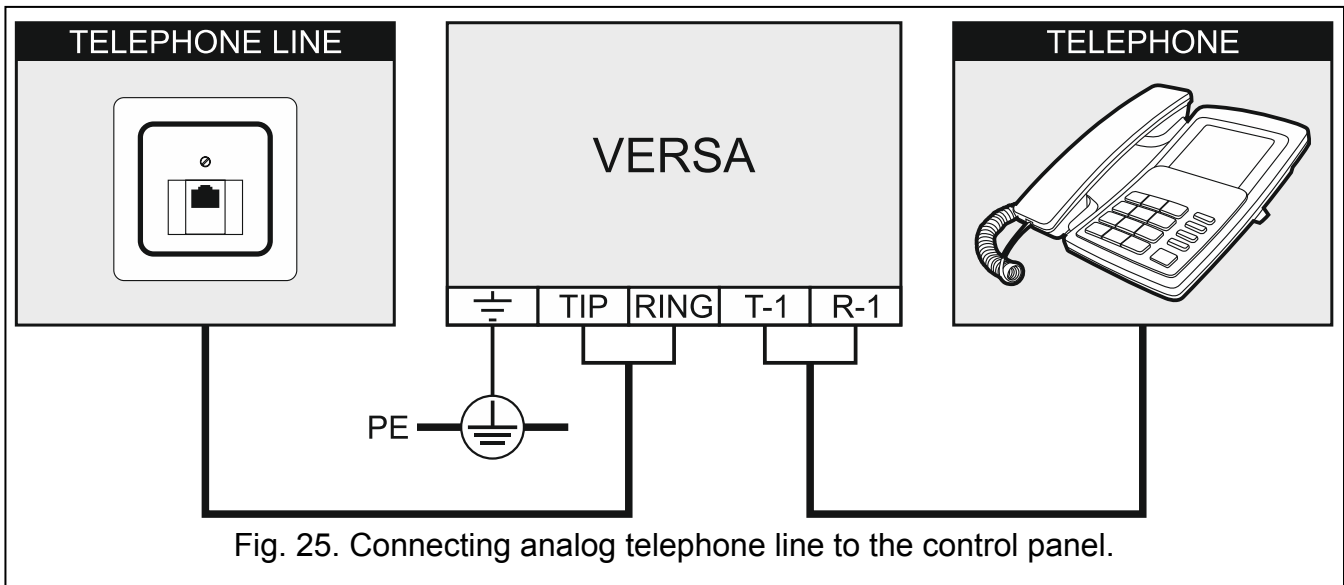

5.10 Connecting the power supply and starting the control panel



Do not connect power until all installation operations are completed.

5.10.1 Main power supply

The control panel requires 18 V AC ($\pm 10\%$) power supply. It is recommended that a transformer with up to 40 VA rating be used.

The transformer should be permanently connected to the 230 V AC mains supply. Before you make the cabling, familiarize yourself with the electrical installation of the facility. Make sure that the circuit you choose for powering the control panel will be always alive. The circuit must be provided with a 2-pole switch disconnecter with at least 3 mm contact separation and/or short-circuit protection with a 16 A time-delay fuse. The owner or user of the alarm system should be instructed on how to disconnect the transformer from the mains (e.g. by indicating the fuse which protects the control panel supply circuit).



Never connect two devices with power supply unit to one transformer.

Before connecting transformer to a circuit from which it will be powered, make sure the circuit is de-energized.

5.10.2 Backup power supply

A 12 V lead-acid sealed battery should be connected to the control panel as a backup power source. The battery capacity must be adequately selected to match current consumption in the system. According to EN 50131 Grade 2, the battery must ensure operation of the system without mains supply for 12 hours.

If the battery voltage drops below 11 V for longer than 12 minutes (3 battery tests), the control panel will indicate battery failure. When the voltage goes down to approx. 10.5 V, the battery will be disconnected.



Do not connect deeply discharged battery to the control panel (with voltage across unloaded terminals below 11 V). The battery should be precharged with a proper charger.

The used batteries must not be discarded, but should be disposed of in accordance with the existing rules for environment protection.

5.10.3 Control panel power-up / start-up procedure

1. De-energize the 230 V AC circuit to which the transformer is to be connected.
2. Connect the 230 V AC wires to the terminals of transformer primary winding.
3. Connect the terminals of transformer secondary winding to the control panel AC terminals. To make the connection, use flexible conductors with a cross-section of 0.5 – 0.75 mm², or rigid conductors with a cross-section of 1 – 2.5 mm².
4. Connect the battery to the dedicated leads (positive terminal to RED lead, negative terminal to BLACK lead). If the battery has screw-type cable lugs, use adapters delivered with the control panel (do not cut off the battery cable lugs). **The control panel will not start after connecting the battery alone.**
5. Turn on 230 V AC power supply in the circuit to which the transformer is connected. The control panel will start operating.



The above mentioned power-up sequence (first the battery, then the 230 V AC mains) will ensure proper operation of the power supply unit and the electronic protection circuits, thus preventing damage to the alarm system components caused by installation mistakes, if any.

If it is necessary to de-energize the control panel, turn off the main power supply (AC) first, and the backup power supply (battery) afterwards. Observe the above described procedure when reconnecting the power supply.







5.10.4 Emergency procedure of the control panel start-up

If the control panel fails to start properly, keypads are not supported, codes are not accepted by the control panel etc., despite all connections having been made correctly, follow the steps below:

1. Turn off the control panel power supply (first disconnect the AC power, and then the battery).
2. Put a jumper on the RESET pins.
3. Turn on the control panel power supply (first connect the battery and then the AC power).
4. Wait a few seconds and remove the jumper from the RESET pins. The control panel will enter the service mode. The service mode menu will be displayed on the keypad with the lowest address (in the case of a wireless keypad, the menu will be displayed on pressing any key).



If the SERVICE MODE FROM RESET PINS option is disabled in the control panel then, depending on the type of keypad in which the lowest address is set:

- LCD: the ,  and  (of the second partition) LEDs will be lit, and the message “Restore factory settings ? 1=Yes” will come up on the display,
- LED: the , and  (of the second partition) LEDs will be lit and the  LED will be blinking rapidly.

Pressing the  key will reset the control panel to its factory settings, but will enable entering the service mode.

5.10.5 First steps after starting-up the control panel

Having started the control panel with factory defaults:

1. Set individual, correct addresses in the keypads.
2. Run the identification function for devices connected to the communication bus of the control panel.

Programming the control panel settings will only be possible after completion of the above steps.











5.11 Programming addresses for the hardwired keypads

Each keypad connected to the control panel must have an individual address set within the 0 to 5 range. By default, address 0 is set in all wired keypads. When started with factory default settings, the control panel will support all keypads connected to the bus, irrespective of what addresses are set in them. Thus it is possible to set correct individual addresses in the keypads.

i Remember to program an individual address if a new keypad is connected to the already functioning alarm system.

5.11.1 Programming the address by means of the service function

i The address programming function can be started from either a wired or wireless keypad, but it will only allow setting addresses in the wired keypads.

1. Enter the service code (by default 12345) and press the  key.
2. Press in turn the     keys. The service mode will start.
3. Press in turn the      keys. The KEYPADS ADDR. function will start. All LEDs designated with icons will start blinking in keypads and information on the current address will be presented by means of:

LCD: displayed message – see Fig. 26,

LED: rapid blinking of the LED designated with the number corresponding to the keypad address (for address 0 – LED 30) – see Fig. 27.

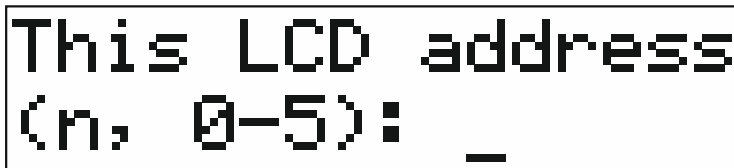

n=0...5 currently set keypad address

Fig. 26. Programming LCD keypad address.

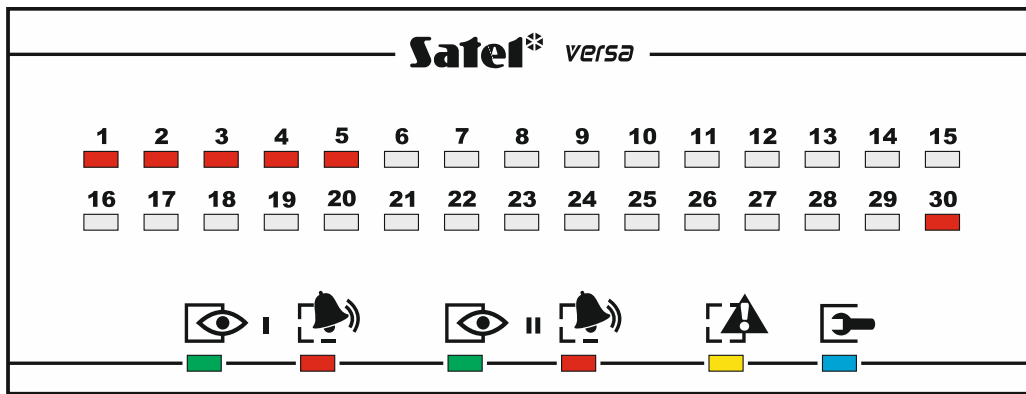



Fig. 27. Programming LED keypad address. LEDs designated with numbers from 1 to 5 and 30 are used for address presentation (30 – for address 0). The LED corresponding to the current address is blinking rapidly, the other ones are lit.

4. In the keypad in which a new address is to be set, press the key number corresponding to the new address. The address change will be confirmed by four short beeps followed by a long one.
5. Press the  key to finish the function. The keypad will be restarted. The function will be finished automatically after 2 minutes since it was launched.

5.11.2 Programming the address without entering the service mode

This way of address programming is useful when the keypad operation is blocked and starting the service mode is impossible.

1. Power off the keypad.
2. Disconnect cables from the keypad CLK and DTA terminals.
3. Short the CLK and DTA keypad terminals.
4. Power on the keypad. The LEDs designated with icons will start blinking in the keypads and information on the current address will be presented by means of:
 - LCD: displayed message,
 - LED: rapid blinking of the LED designated with the number corresponding to the keypad address – see Fig. 27.
5. Press the key with the number corresponding to the new address. The address change will be confirmed by four short beeps followed by a long one. Pressing  allow to change the address again (the keypad restart will follow and information on the current address will be displayed again).
6. Power off the keypad.
7. Open the CLK and DTA keypad terminals.
8. Connect cables properly to the CLK and DTA keypad terminals.
9. Power on the keypad.









5.12 Identification of devices connected to the bus

Devices connected to the communication bus will not be properly supported, unless they have been identified by the control panel. Identification of the devices is required after the first start-up of the control panel and then each time after a new device is added or the address was changed in a device supported by the control panel.



Disconnecting an identified device from the communication bus will trigger the tamper alarm.

5.12.1 Starting the identification function from keypad

1. Enter the service code (by default 12345) and press the  key.
2. Press in turn the    keys. The service mode will start.
3. Press in turn the     keys. The IDENTIFICATION function will start. Three short beeps will indicate that identification has been completed and information on the identified devices will be presented (on the display in the LCD keypad and by means of LEDs in the LED keypad).
4. Press the  key to quit the function.



If the identification is terminated by two long beeps, this means that a wrong address is set in the device connected to the communication bus (unsuitable for this type of device or the same in at least two devices). The displayed message (in the LCD keypad) or the blinking LED corresponding to the device address (in the LED keypad) will be helpful in diagnosing the problem. Press , set the correct address in the device, and then restart the IDENTIFICATION function.

5.12.2 Starting the identification function from DLOADX program

1. Click on the  button in the main menu. The “VERSA – Structure” window will open.
2. Click on the “Hardware” tab.
3. Click on the “Expanders” branch.
4. Click on the “Identification” button to run the identification function.
5. After the identification is finished, a window will appear with a prompt whether to read the data. Click “OK”.

5.13 Connecting the computer to the control panel

Using a computer, you can configure the alarm system (DLOADX program) or update the control panel firmware. The communication is encrypted. The RS-232 port (TTL) of the control panel can be connected with the USB port of the computer by means of the USB-RS converter offered by SATEL.

5.14 Installation of ABAX wireless devices



This section does not cover installation of the wireless keypads. They constitute a separate category of devices and should be installed according to the manual delivered with the device.

If an ABAX wireless system controller (ACU-120 / ACU-270 / ACU-100 / ACU-250) is connected to the control panel, you can proceed to installation of ABAX wireless devices after control panel start-up and controller identification by the control panel. Before installing a wireless device, check the level of radio signal received by the device from controller and by the controller from device at the planned installation place. The ARF-100 tester is a useful tool to check the signal level. The level of signal received by device/controller may not be lower than 40%. If the radio signal level at the planned installation place is too low, select another installation location. Sometimes it is sufficient to move the device ten or twenty centimeters to obtain a significant improvement of signal quality. You can install the device permanently only after reaching the optimum level of radio signal.

The wireless devices must be registered to the alarm system. This can be done using the DLOADX program or LCD keypad.

5.14.1 Adding new ABAX wireless devices

The control panel can support up to 30 wireless devices. The number of actually supported devices depends on how many positions the individual devices occupy. Each position means one wireless zone or one wireless zone and one wireless output.

If a device occupies two or more positions, its addition will respectively decrease the number of wireless devices that can still be registered (e.g. after adding a ACX-200 expander, which takes up 4 positions, the controller can still support 26 other wireless devices).

Even if a device occupies several zones in the system, only the first of them should be indicated during the device adding procedure. The next ones are assigned automatically (these are the zones following the selected one).



For some wireless devices, you can select whether the device will take up one or two positions (channels) on the list of devices. Depending on the device, if one position is selected:

- AMD-101 – only additional NC input will be supported,
- AMD-102 – only additional inputs (roller shutter and NC) will be supported;
- AOD-200 – only the motion detector will be supported;
- AVD-100 – only the vibration detector will be supported.

If the device occupies an output as well, its number will be the same as the number of zone selected during the device adding procedure.

The control panel does not support wireless outputs with numbers from 13 to 30.

DLOADX program







You can add ABAX wireless devices in the “VERSA – Structure” window, “Hardware” tab, after clicking on the ABAX system controller name in the list of devices.

1. In the “Zones/Outputs” tab, click on the “Read” button to read the data related to wireless devices from the controller (these data are not read after clicking on the  button in the main menu).
2. Click on the zone to which a new wireless device is to be assigned (you can also select the zone later in the “New wireless dev.” window).
3. Click on the “New device” button. The “New wireless dev.” window will open.
4. Enter the 7-digit serial number of the added device. The serial number can be found on the electronics board or on the enclosure. Each ARF-100 radio signal level tester has serial number 0000500.
5. Depending on the device type:
ACX-200 / ACX-201: power-up the expander,
ARF-100: turn on the device,
ASW-100 E / ASW-100 F: insert the controller into 230 V AC socket,
other devices: open the tamper contact.
6. The message will confirm that a new device has been added (unless you have entered an invalid serial number, of which you will be informed by a message). The new zone name will be displayed. You can change it. The same name will also be given to the output, if the device is assigned to the output.
7. Click on the “OK” button (you can click on the “Quit” button to cancel adding a new device or on the “Next” button to proceed to adding a next wireless device).

8. Click on the “Write” button to write the new wireless device data to the controller (these data will not be written after clicking on the  button in the main menu).

LCD keypad

You can add ABAX wireless devices in the service mode by means of the NEW DEVICE function (SERVICE MODE ►2. HARDWARE ►1. KPDS. & EXPS. ►3. WIRELESS MOD. ►1. NEW DEVICE).

1. Having started the function, enter the 7-digit serial number of the added device and press the  key. The serial number can be found on the electronics board or on the enclosure. Each ARF-100 radio signal level tester has serial number 0000500.
2. When the “Open device tamper” message is displayed, depending on the device type:
ACX-200 / ACX-201: power-up the expander,
ARF-100: turn on the device,
ASW-100 E / ASW-100 F: insert the controller into 230 V AC socket,
other devices: open the tamper contact.
3. Information on the device to be added will be displayed (if nothing happens, it can mean that you have entered an invalid serial number – if this is the case, press  to return to the submenu). Press to confirm your intention to add a device.
4. Using the  and  keys, select the zone to which the device is to be assigned and then press .
5. The new name of the zone will be displayed. You can change it. The same name will also be given to the output, if the device is assigned to the output. Press  to save the name. If the device takes up several positions, the name-giving procedure must be repeated for them.
6. In the next steps, you can configure the device (see the PROGRAMMING manual).

5.14.2 Removing ABAX wireless devices



DLOADX program

You can remove ABAX wireless devices in the “VERSA – Structure” window, “Hardware” tab, after clicking on the ABAX system controller name in the list of devices.

1. In the “Zones/Outputs” tab, click on the “Read” button to read the data related to wireless devices from the controller.
2. Click on the zone to which the device you want to delete is assigned (if the device is assigned to several zones, you can click on any of them).
3. Click on the “Delete” button. The “Confirm” window will open.
4. Click on the “Yes” button. The “Confirm” window will close.
5. Click on the “Write” button to save the changes to the controller.

LCD keypad

You can remove ABAX wireless devices in the service mode by means of the REMOVE DEVICE function (SERVICE MODE ►2. HARDWARE ►1. KPDS. & EXPS. ►3. WIRELESS MOD. ►3. REMOVE DEVICE).

1. Having started the function, use the  and  keys to select the zone to which the wireless device to be removed is assigned, and then press .
2. A prompt will appear asking you whether the device is to be deleted (device type and serial number will be displayed). Press . The device will be deleted.

5.15 Installation of 433 MHz wireless detectors

If the 433 MHz wireless system controller (VERSA-MCU) is connected to the control panel, you can proceed to installation of the 433 MHz wireless detectors after control panel start-up and controller identification by the control panel. Before installation of the detector, register it in the controller and check, if transmissions from the detector located at the planned installation place can reach the controller. To send a transmission, you can e.g. open the detector tamper switch. If transmissions from the detector planned installation place do not reach the controller, select another location. Sometimes, it is sufficient to move the detector by some ten to twenty centimeters. Only after making sure that the controller receives transmissions from the detector, you can install the detector permanently.



The wireless detectors must be registered to the alarm system. This can be done using the DLOADX program or LCD keypad.

5.15.1 Adding new 433 MHz wireless detectors

The control panel can support up to 30 wireless detectors.



DLOADX program







You can add 433 MHz wireless detectors in the “VERSA – Structure” window, “Hardware” tab, after clicking on the VERSA-MCU controller name in the list of devices.

1. Click on the “Read” button to read the data related to wireless detectors from the controller (these data are not read after clicking on the  button in the main menu).
2. Click on the zone to which a new wireless detector is to be assigned (you can also select the zone later in the “New wireless dev.” window).
3. Click on the “New device” button. The “New wireless dev.” window will open.
4. Enter the 7-digit serial number of the added detector. The serial number can be found on the electronics board or on the enclosure.
5. Open the detector tamper contact.
6. The message will confirm that a new detector has been added (unless you have entered an invalid serial number, of which you will be informed by a message). The new zone name will be displayed. You can change it.
7. Click on the “OK” button (you can click on the “Quit” button to cancel adding a new detector or on the “Next” button to proceed to adding a next wireless detector).
8. Click on the “Write” button to write the new wireless detector data to the controller (these data will not be written after clicking on the  button in the main menu).

LCD keypad

You can add the 433 MHz wireless detectors in the service mode by means of the NEW DEVICE function (SERVICE MODE ►2. HARDWARE ►1. KPDS. & EXPS. ►3. WIRELESS MOD. ►1. NEW DEVICE).

1. Having started the function, enter the 7-digit serial number of the added detector and press the  key. The serial number can be found on the electronics board or on the enclosure.
2. Open the detector tamper contact.
3. Information on the detector to be added will be displayed (if nothing happens, it can mean that you have entered an invalid serial number – if this is the case, press  to return to the submenu). Press  to confirm your intention to add a detector.

4. Using the  and  keys, select the zone to which the detector is to be assigned and then press  .
5. The new name of the zone will be displayed. You can change it. Press   to save the name.
6. In the next step, define whether the detector presence is to be monitored (see the PROGRAMMING manual).

5.15.2 Removing 433 MHz wireless detectors





DLOADX program

You can remove the 433 MHz wireless detectors in the “VERSA – Structure” window, “Hardware” tab, after clicking on the VERSA-MCU controller name in the list of devices.

1. Click on the “Read” button to read the data related to wireless detectors from the controller.
2. Click on the zone to which the detector you want to delete is assigned.
3. Click on the “Delete” button. The “Confirm” window will open.
4. Click on the “Yes” button. The “Confirm” window will close.
5. Click on the “Write” button to save the changes to the controller.

LCD keypad

You can remove the 433 MHz wireless detectors in the service mode by means of the REMOVE DEVICE function (SERVICE MODE ►2. HARDWARE ►1. KPDS. & EXPS. ►3. WIRELESS MOD. ►3. REMOVE DEVICE).

1. Having started the function, use the  and  keys to select the zone to which the wireless detector to be removed is assigned, and then press  .
2. A prompt will appear asking you whether the detector is to be deleted (detector type and serial number will be displayed). Press . The detector will be deleted.

6. Numeration of zones and outputs in the system

6.1 Numeration of zones



If the zone numbers coincide, you can select which zone will be supported (see: PROGRAMMING manual).

6.1.1 Hardwired zones

The zones on control panel PCB always have initial numbers:

- VERSA 5 – from 1 to 5,
- VERSA 10 – from 1 to 10,
- VERSA 15 – from 1 to 15.

The zones in expanders are numbered depending on the address which is set in them:

- expander with address 12 (0Ch) – numbers from 7 to 14,
- expander with address 13 (0Dh) – numbers from 15 to 22,
- expander with address 14 (0Eh) – numbers from 23 to 30.

6.1.2 Wireless zones

The numbers of wireless zones are defined when adding the wireless devices. You can select any zone number which is not occupied by another wireless device.

6.2 Numeration of outputs

The control panel supports outputs having numbers from 1 to 12. The numbers of hardwired and wireless outputs may coincide. The control panel will support them simultaneously.

6.2.1 Hardwired outputs

The hardwired outputs are assigned numbers automatically:

- the outputs on control panel main board have numbers from 1 to 4,
- the outputs in expander have numbers from 5 to 12.

6.2.2 Wireless outputs

The numbers of wireless outputs are defined when adding the wireless devices. The wireless output number is identical to that of the wireless zone. This means that the wireless outputs may be assigned numbers from 1 to 30, though **the control panel does not support the outputs having numbers from 13 to 30.**

7. Specifications

7.1 Control panel

Supply voltage	18 V AC \pm 15%, 50-60 Hz
Recommended transformer	40 VA
Standby current consumption	VERSA 5 70 mA
	VERSA 10 100 mA
	VERSA 15 135 mA
Maximum current consumption	VERSA 5 90 mA
	VERSA 10 125 mA
	VERSA 15 160 mA
Battery failure voltage threshold	11 V \pm 10%
Battery cut-off voltage	10.5 V \pm 10%
Battery charging current.....	350 mA
Power supply output current	VERSA 5 1 A
	VERSA 10 2 A
	VERSA 15 2 A
Power supply output voltage.....	12 V DC \pm 15%
Power supply output voltage range.....	10.5 V...14 V DC
High-current programmable outputs	1100 mA / 12 VDC
Low-current programmable outputs	50 mA / 12 VDC
KPD output	500 mA / 12 V DC
AUX output	500 mA / 12 V DC
Hardwired programmable zones	VERSA 5 5
	VERSA 10 10
	VERSA 15 15
Maximum number of programmable zones.....	30
Hardwired programmable outputs.....	4
Maximum number of programmable outputs	12

Power supply outputs.....		2
Communication buses.....		1
Keypads.....		up to 6
Partitions.....		2
Telephone numbers for messaging.....		8
Voice messages.....		16
Text messages.....		64
Users.....		30
Timers.....		4
Event log.....		2047
Security grade according to EN50131.....		Grade 2
Environmental class according to EN50130-5.....		II
Operating temperature range.....		-10...+55°C
Maximum humidity.....		93±3%
Electronics board dimensions	VERSA 5.....	120 x 68 mm
	VERSA 10.....	150 x 68 mm
	VERSA 15.....	180 x 68 mm
Weight	VERSA 5.....	100 g
	VERSA 10.....	114 g
	VERSA 15.....	131 g

7.2 VERSA-LCD keypad

Supply voltage.....		12 V DC ±15%
Standby current consumption	VERSA-LCD-GR.....	36 mA
	VERSA-LCD-BL.....	40 mA
Maximum current consumption	VERSA-LCD-GR.....	110 mA
	VERSA-LCD-BL.....	130 mA
Environmental class according to EN50130-5.....		II
Operating temperature range.....		-10...+55°C
Maximum humidity.....		93±3%
Enclosure dimensions.....		114.5 x 95 x 22.5 mm
Weight.....		123 g

7.3 VERSA-LCDM keypad

Supply voltage.....		12 V DC ±15%
Standby current consumption.....		50 mA
Maximum current consumption.....		60 mA
Security grade according to EN50131.....		Grade 2
Environmental class according to EN50130-5.....		II
Operating temperature range.....		-10...+55°C
Maximum humidity.....		93±3%
Enclosure dimensions.....		139 x 124 x 22 mm
Weight.....		236 g

7.4 VERSA-LCDR keypad

Supply voltage	12 V DC \pm 15%
Standby current consumption	30 mA
Maximum current consumption	65 mA
Security grade according to EN50131	Grade 2
Environmental class according to EN50130-5	II
Operating temperature range.....	-10...+55°C
Maximum humidity	93 \pm 3%
Enclosure dimensions.....	139 x 124 x 22 mm
Weight.....	240 g

7.5 VERSA-LED keypad

Supply voltage	12 V DC \pm 15%
Standby current consumption	VERSA-LED-GR 33 mA
	VERSA-LED-BL 40 mA
Maximum current consumption	VERSA-LED-GR 110 mA
	VERSA-LED-BL 120 mA
Environmental class according to EN50130-5	II
Operating temperature range.....	-10...+55°C
Maximum humidity	93 \pm 3%
Enclosure dimensions.....	114.5 x 95 x 22.5 mm
Weight.....	97 g

8. Manual update history

The table presents changes made since version 06/15.

Manual version	Introduced changes
10/15	<ul style="list-style-type: none"> Information on the number of output functions has been updated (p. 4). Information on INT-TSH keypad has been added (p. 6). Information on VERSA-LCDR keypad has been added (p. 6 and p. 33). Information on built-in proximity card reader has been added (p. 7).
04/16	<ul style="list-style-type: none"> Note about ABAX wireless detectors which can take up one or two positions on the list of devices has been added (p. 27).
11/17	<ul style="list-style-type: none"> Information that you can define whether the AMD-101 detector is to occupy one or two positions on the list of wireless devices has been added (s. 27).

