

Keypad **INT-TSG** Installer Manual



Firmware version 1.03

WARNINGS

The keypad should be installed by qualified personnel.

Read carefully this manual before proceeding to installation.

Changes, modifications or repairs not authorized by the manufacturer shall void your rights under the warranty.

SATEL's goal is to continually upgrade the quality of its products, which may result in alterations of their technical specifications and firmware. The current information on the introduced modifications is available on our website.

Please visit us:
<http://www.satel.eu>

The declaration of conformity may be consulted at www.satel.eu/ce

The following symbols may be used in this manual:



- note;



- caution.

CONTENTS

1.	Introduction.....	2
2.	Features	2
3.	Installation and hook-up	2
3.1	Description of terminals	4
4.	Addressing	4
4.1	Keypad connected to INTEGRA / INTEGRA Plus control panel.....	4
4.1.1	Programming keypad address by means of service function	4
4.2	Keypad connected to VERSA / VERSA Plus control panel	5
4.2.1	Programming keypad address by means of service function	5
4.3	Programming address without entering the service mode.....	5
5.	Keypad identification	5
5.1	Keypad connected to INTEGRA / INTEGRA Plus control panel.....	6
5.2	Keypad connected to VERSA / VERSA Plus control panel	6
6.	microSD memory card.....	6
6.1	Inserting the microSD card	6
6.2	Removing the microSD card.....	7
7.	Keypad configuring.....	7
7.1	Keypad connected to INTEGRA / INTEGRA Plus control panel.....	7
7.1.1	Keypad	7
7.1.2	State inspections	11
7.1.3	User functions definition	12
7.1.4	Macro commands.....	12
7.1.5	Status screen	17
7.1.6	End-of-line resistance.....	19
7.2	Keypad connected to VERSA / VERSA Plus control panel	20
7.2.1	Parameters and options	20
7.2.2	Status screen	23
8.	Updating the keypad firmware.....	24
9.	Specifications	25
10.	Manual update history	26

1. Introduction

The INT-TSG keypad allows operation and programming of the INTEGRA, INTEGRA Plus, VERSA and VERSA Plus control panels. This manual applies to the keypad with firmware version 1.03, which is supported by the following control panels:

- INTEGRA and INTEGRA Plus with firmware version 1.13 or newer,
- VERSA and VERSA Plus with firmware version 1.04 or newer.

For programming of keypad, the DLOADX program version 1.13.004 or newer is required.

Changes made to the firmware version 1.03

- Keypad volume control by the user through the graphic interface.
- Ability to display slide show / clock as a screensaver after 10 minutes' inactivity of the keypad.
- Ability to define response of the keypad to wake-up (after a tap on the screen by the user or occurrence of a specified event in the system).
- Compatibility with the VERSA and VERSA Plus control panels.

2. Features

- 4.3" touch screen.
- Intuitive icon-based menu.
- Alarm system control by means of macro commands to start a number of different functions in the control panel.
- Customizable status screen.
- Display of slide show as a background of the status screen.
- LEDs indicating the state of partitions and system.
- Built-in reader of microSD memory cards.
- Built-in sounder.
- 2 programmable hardwired zones (supported if the keypad is connected to INTEGRA / INTEGRA Plus):
 - support for NO and NC type detectors, as well as roller shutter and vibration detectors;
 - support for Single EOL, Double EOL and Triple EOL configuration (Triple EOL when working with INTEGRA Plus control panels);
 - programming end-of-line resistor values.
- Tamper contact reacting to the enclosure opening or detaching from the wall.

3. Installation and hook-up



Disconnect power before making any electrical connections.

The INT-TSG keypad is designed for indoor installation. The place of installation should be readily accessible to the system users.

1. Open the keypad enclosure (see Fig. 1). The enclosure opening tool, shown in the illustration, is included in the keypad delivery set.
2. Place the enclosure base on the wall and mark the location of mounting holes. Be sure to take into account the tamper element mounting hole.
3. Drill the holes for wall plugs (screw anchors).

4. Pass the cables through the opening in the enclosure base.
5. Using wall plugs (screw anchors) and screws, fasten the enclosure base to the wall.
6. Connect the DTM, CKM and COM keypad terminals to the appropriate terminals of the control panel communication bus (see Fig. 2). It is recommended that the unshielded non-twisted cable be used for making the connection. If you use the twisted-pair type of cable, remember that CKM (clock) and DTM (data) signals must not be sent through one twisted-pair cable. The wires must be run in one cable. The length of cables must not exceed 300 m.

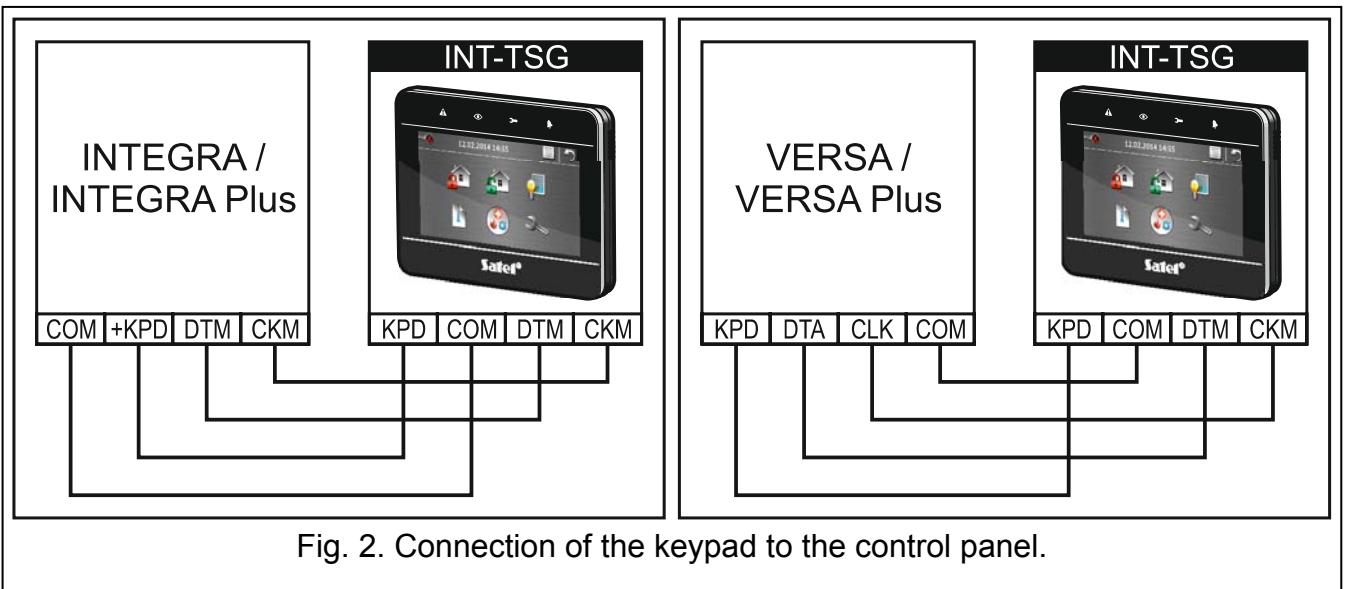
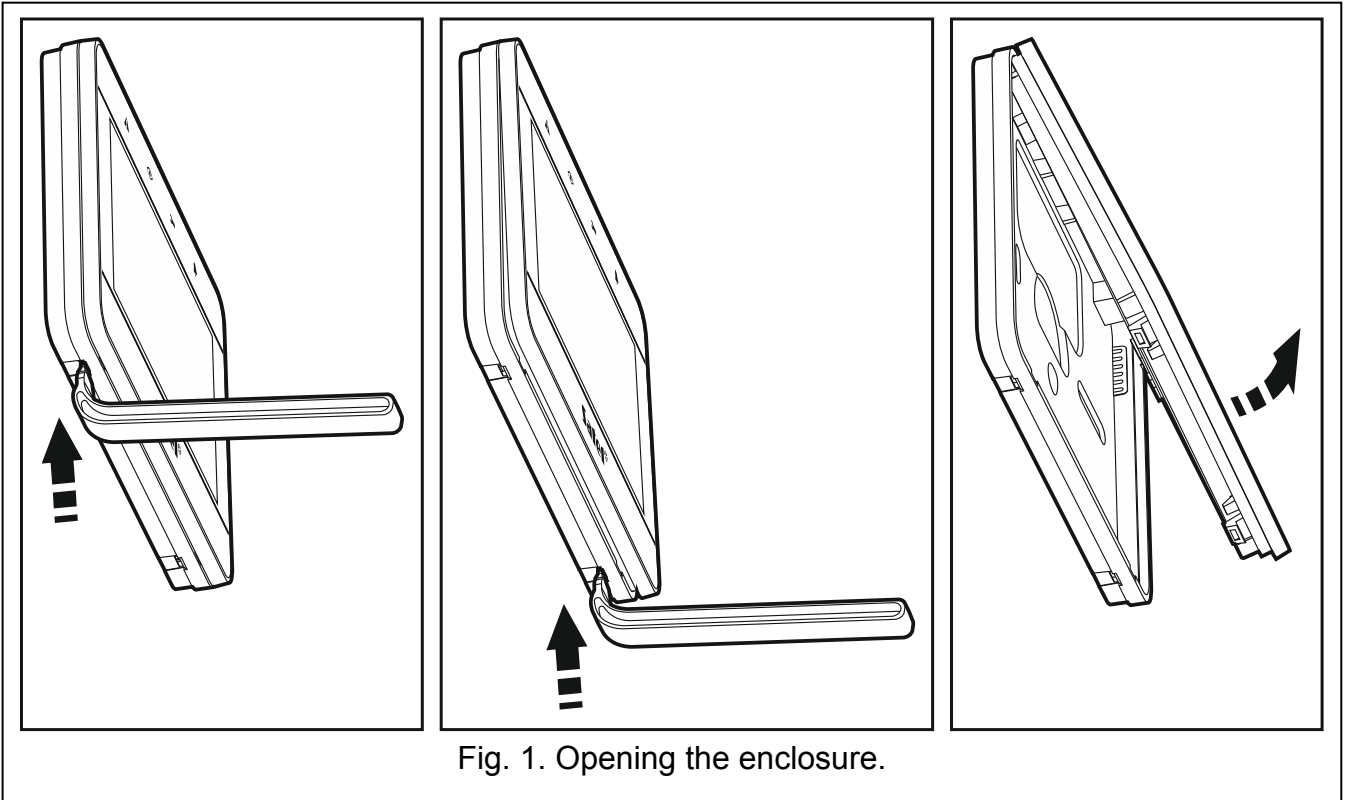

7. Connect the wires to the terminals of additional zones, if any detectors are to be connected to them (the detectors are to be connected in the same way as to the control panel onboard zones).

8. Connect the supply wires to the KPD and COM terminals. The keypad can be powered directly from the control panel, from expander with power supply or from a power supply unit.
9. Place the front panel onto the catches, snap close the enclosure.

3.1 Description of terminals

- KPD** - power supply input.
COM - common ground.
DTM - data.
CKM - clock.
A RS485 B - unused terminals.
Z1, Z2 - zones.

4. Addressing

Each keypad connected to the control panel must have its individual address set on it. By default, address 0 is set in the keypad.



When started, only the control panel with factory default settings can provide support for all keypads connected to the bus, irrespective of the addresses set in them. In all other cases, the control panel will block operation of the keypads having identical addresses.





4.1 Keypad connected to INTEGRA / INTEGRA Plus control panel

The keypad must have an address set in it:

- from the 0 to 3 range, if it is connected to the INTEGRA 24 or INTEGRA 32 control panel;
- from 0 to 7 range, if it is connected to another INTEGRA or INTEGRA Plus control panel.

The address set in the keypad determines the numbers to be given to the keypad zones (see the INSTALLER MANUAL for INTEGRA or INTEGRA Plus control panels).

4.1.1 Programming keypad address by means of service function











1. Tap  on the main screen. The “Advanced” screen will be displayed.
2. Tap . The terminal will be displayed.
3. Enter the **service code** (by default: 12345) and tap . The user menu will be displayed.
4. Tap . The service mode will start up.
5. Start the KEYPADS ADDR. function (►STRUCTURE ►HARDWARE ►IDENTIFICATION ►KEYPADS ADDR.). The “This LCD address (n, 0-x)” message will appear on the displays of all keypads connected to the control panel (n – keypad address; 0-x – range of supported addresses).
6. Tap the key with the digit corresponding to the address which is to be programmed on the keypad.
7. To terminate the address change function, tap . The function will be terminated automatically after 2 minutes from being started. Termination of the function will restart

the keypad (the service mode menu will be displayed on the keypad with the lowest address).

4.2 Keypad connected to VERSA / VERSA Plus control panel

An address from within the 0 do 5 range must be set on the keypad.

4.2.1 Programming keypad address by means of service function

1. Tap  on the main screen. The “Advanced” screen will be displayed.
2. Tap . The terminal will be displayed.
3. Enter the **service code** (by default: 12345) and tap . The user menu will be displayed.
4. Tap in turn   . The service mode will start up.
5. Tap in turn    . The KEYPADS ADDR. function will start. On all keypads, LEDs designated by icons will start blinking and current address information will be presented.
6. Tap the key with the digit corresponding to the address which is to be programmed on the keypad.
7. To terminate the address change function, tap . The function will be terminated automatically after 2 minutes from being started. Termination of the function will restart the keypad.

4.3 Programming address without entering the service mode

This way of address programming is useful when the keypad operation is blocked and starting the service mode is impossible. It can be used irrespective of which control panel the keypad is connected to.

1. Turn off keypad power supply.
2. Disconnect wires from the keypad terminals CKM and DTM.
3. Short the keypad terminals CKM and DTM.
4. Turn on keypad power supply. A message indicating the current address will appear on the display.
5. Tap the key with the digit corresponding to the address which is to be programmed on the keypad.
6. Turn off keypad power supply.
7. Open the keypad terminals CKM and DTM.
8. Connect wires, as required, to the keypad terminals CKM and DTM.
9. Turn on keypad power supply.

5. Keypad identification

The alarm system can only be programmed and operated from keypads that have been identified by the control panel. The keypad identification function should be executed at the first start-up of the control panel, and then each time when adding a new keypad or changing address in a keypad supported by the control panel. Disconnecting an identified keypad from the bus will trigger the tamper alarm.

5.1 Keypad connected to INTEGRA / INTEGRA Plus control panel

The identification function can be run by using:

- LCD keypad: ►SERVICE MODE ►STRUCTURE ►HARDWARE ►IDENTIFICATION ►LCD KEYPADS ID. How to enter the service mode, refer to section on programming keypad address by means of the service function (p. 4).
- DLOADX program: →“Structure” window →“Hardware” tab →“Keypads” item →“Keypads identification” button.

5.2 Keypad connected to VERSA / VERSA Plus control panel

To run the identification function for keypads and expanders you can use:

- keypad: ►SERVICE MODE ►2. HARDWARE ►1. KPDS. & EXPS. ►1. IDENTIFICAT. How to enter the service mode, refer to the section on programming keypad address by means of the service function (p. 5).
- DLOADX program: →“Versa – Structure” window →“Hardware” tab →“Expanders” branch →“Identification” button.

6. microSD memory card

On the microSD memory card:

- you can put the additional macro command icons;
- you can put photos which will be used for the slide show;
- you should put the file with a new version of the keypad firmware, if the firmware is to be updated.

The keypad supports the microSD and microSDHC memory cards.



The microSD memory card should be purchased separately.

Inserting and removing the memory card requires opening of the keypad enclosure, so if the alarm system is working, remember to start the service mode.

6.1 Inserting the microSD card

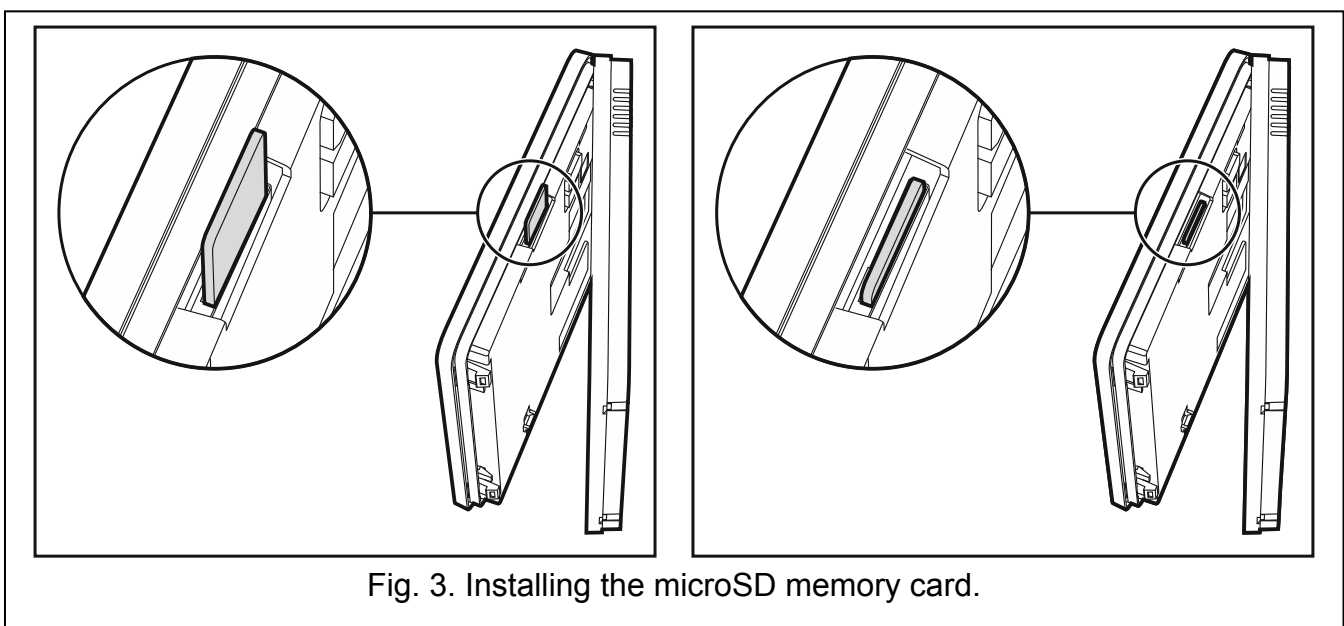

Fig. 3. Installing the microSD memory card.

1. Open the keypad enclosure (see: Fig. 1).
2. Insert the card into its slot (see Fig. 3) and push until it clicks into place. The card contacts should be directed toward the display.
3. Close the keypad enclosure.

6.2 Removing the microSD card

1. Open the keypad enclosure (see: Fig. 1).
2. Push the card to release it.
3. Remove the card from its slot.

7. Keypad configuring

7.1 Keypad connected to INTEGRA / INTEGRA Plus control panel

To configure the keypad settings you can use:

- DLOADX program: →“Structure” window →“Hardware” tab →“Keypads” branch →[*keypad name*]. The DLOADX program alone makes it possible to configure all the settings.
- LCD keypad: ►SERVICE MODE ►STRUCTURE ►HARDWARE ►LCD KEYPADS ►SETTINGS ►[*keypad name*]. How to enter the service mode, refer to the section on programming keypad address by means of the service function (p. 4).

7.1.1 Keypad

Shown in square brackets are the names displayed on keypads.

Name – individual name of the keypad (up to 16 characters).

Partitions managed by keypad [Partitions] – the partitions which can be armed/disarmed or alarm in which may be cleared from the keypad. These functions are available to the users having a suitable authority level and access to those partitions.



Using the service code you can operate all partitions, irrespective of which partitions are operated by the keypad.

Show alarms of partitions [Alarms] – the keypad can signal burglary alarms from selected partitions.

Show fire alarms of partitions [Fire alarms] – the keypad can signal fire alarms from selected partitions.

CHIME signal of zones [Chime zones] – the keypad can audibly signal violation of selected zones. If the zone is armed, violation will not trigger the CHIME signal.

Zone disabling CHIME [Chime bps. zone] – zone, which, if violated, will disable the CHIME feature for specified time.

Bypass time [Chime bps. time] – time during which the CHIME signal will be disabled after violation of the zone which disables the signaling (time is counted from the zone restore). If the value 0 is programmed, the signaling will not be disabled.

Quick Arm partitions [Quickarm part.] – partitions which can be armed without entering the code (quick arming).

Show entry delay of partitions [Entry time p.] – the partitions, for which counting the entry delay will be indicated by text appearing on the display.

Show exit delay of partitions [Exit time part.] – the partitions for which counting the exit delay will be indicated by text appearing on the display.

Date/Time format – the way the time and date are displayed on the keypad main screen and on the terminal.



Alarm messages

Partitions [Part.alarm msg.] – if this option is enabled, messages on partition alarms will be displayed (they contain the name of partition).



Zones [Zone alarm msg.] – if this option is enabled, messages on alarms from zones will be displayed (they contain the name of zone). The zone alarm messages have the priority.

Alarms



FIRE [Fire alarm] – if this option is enabled, you can trigger fire alarm from the keypad by tapping and holding for 3 seconds:

-  on the “Emergency” screen,
-  on the terminal.

PANIC [Panic alarm] – if this option is enabled, you can trigger panic alarm from the keypad by tapping and holding for 3 seconds:

-  on the “Emergency” screen,
-  on the terminal.

AUX. [Medical alarm] – if this option is enabled, you can trigger medical alarm from the keypad by tapping and holding for 3 seconds:

-  on the “Emergency” screen,
-  on the terminal.

3 wrong codes [3 wrong codes] – if this option is enabled, entering incorrect code three times will trigger the alarm.

Additional options

Silent PANIC alarm [Silent panic] – if this option is enabled, the panic alarm triggered from the keypad will be a silent one (without loud signal). Additionally, the silent panic alarm can be triggered by tapping and holding any part of the status screen for about 3 seconds. The option is available, if the PANIC option is enabled.

Sign. entry delay [Entry time s.] – with this option enabled, the keypad will audibly signal the entry delay countdown.

Sign. exit delay [Exit time sig.] – with this option enabled, the keypad will audibly signal the exit delay countdown.

Sign. alarms [Alarm signal.] – with this option enabled, the keypad will signal the alarms audibly.

Key sounds – when this option is enabled, tapping the keypad screen is confirmed by a beep.

Sign. trbl. in part. arm [Trbl. in p.arm.] – with this option enabled, the keypad signals troubles by means of the  LED, if some of the operated partitions are armed (the troubles are not signaled if all partitions are armed).

Sign. new trouble [New trbl. sign.] – with this option enabled, the keypad can audibly signal the occurrence of a new trouble (additionally, the TROUBLE MEMORY UNTIL REVIEW option must be enabled in the control panel – see: control panel programming manual). New trouble signaling is cleared after the troubles have been reviewed by the user.

Show code entering [Show code ent.] – with this option enabled, entering the code is presented on the keypad display by asterisks.

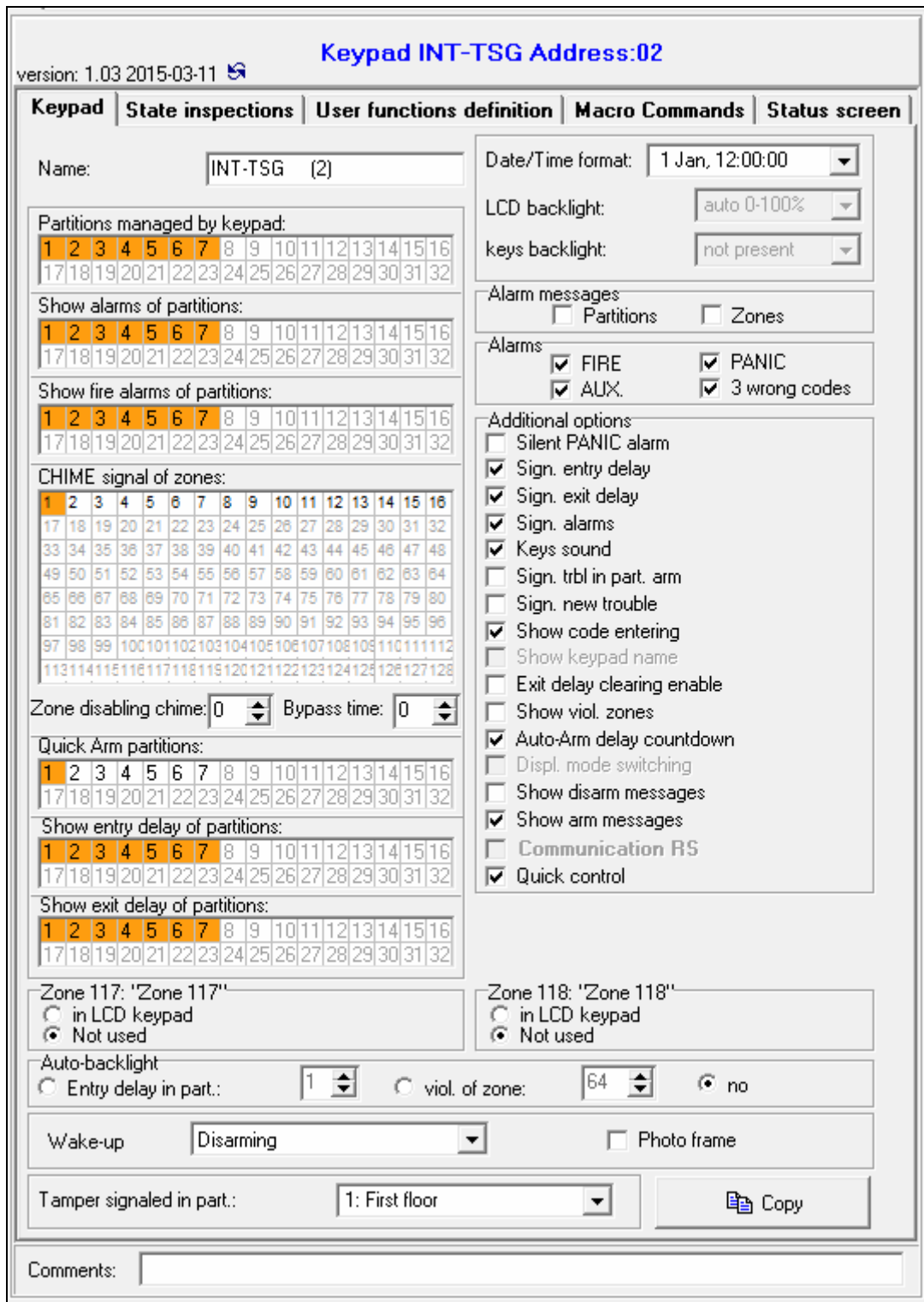

Fig. 4. DLOADX program: parameters and options of keypad connected to INTEGRA / INTEGRA Plus control panel.

Exit delay clearing enable [Fin. exit time.] – with this option enabled, the exit delay time in partitions with the EXIT DELAY CLEARING option enabled can be shortened by means of:

- macro command;
- terminal (after tapping in turn the **9 wxyz** and **# 0** keys).





Show viol. zones [Zone violation] – with this option enabled, violating the CHIME signal triggering zone result additionally in the zone name being displayed.

Auto-Arm delay countdown [Auto-arm delay] – with this option enabled, the auto-arm delay countdown in partition is signaled acoustically.

Show disarm messages [Show disarming] – if this option is enabled, the keypad will inform about disarming with a displayed message at all times. If the option is disabled – only in case of disarming from the given keypad.

Show arm messages [Show arm] – if this option is enabled, the keypad will inform about arming with a displayed message (irrespective of how the system was armed).

Quick control [Control (8#)] – if this option is enabled, the OUTS CONTROL user function can be started without entering the user code:

- after tapping the  icon on the main screen, if no macro command is assigned to the group;
- after tapping and holding the  icon on the main screen for about 3 seconds, if at least one macro command is assigned to the group;
- from the terminal, after you tap in turn the  and  keys.

Zones

For each of the keypad zones can be defined whether it will be used or not.

Auto-backlight

The keypad can be woken up after occurrence of a specified event in the system: starting the entry delay countdown in a selected partition, or violating a selected zone.

Wake-up

You can define how the keypad will respond to the wake-up (after a tap on the screen by the user or occurrence of a specified event in the system):

Status screen – status screen will be displayed.

Menu screen – main screen will be displayed.

Disarming – if at least one partition managed by the keypad is armed, the authorization screen will be displayed (after entering the code and tapping , and depending on the system state: the partition(s) will be disarmed / partition selection screen will be displayed / “Alarm clearing / Disarming” screen will be displayed). If none of the partitions is armed, the main screen will be displayed.

Photo frame – if this option is enabled, the following will be displayed after 10 minutes of keypad inactivity:

slide show – if there are at least two pictures on the memory card and the value of CHANGE PICTURE EVERY parameter is different from 0,

clock – if there are one or no pictures on the memory card or the value of CHANGE PICTURE EVERY parameter is 0.

If this option is disabled, the screen will go blank after 10 minutes of keypad inactivity.

Tamper signaled in part. [Tamper in part.] – partition where alarm will be triggered in the event of keypad tamper (opening the enclosure or disconnecting keypad from the bus).

7.1.2 State inspections

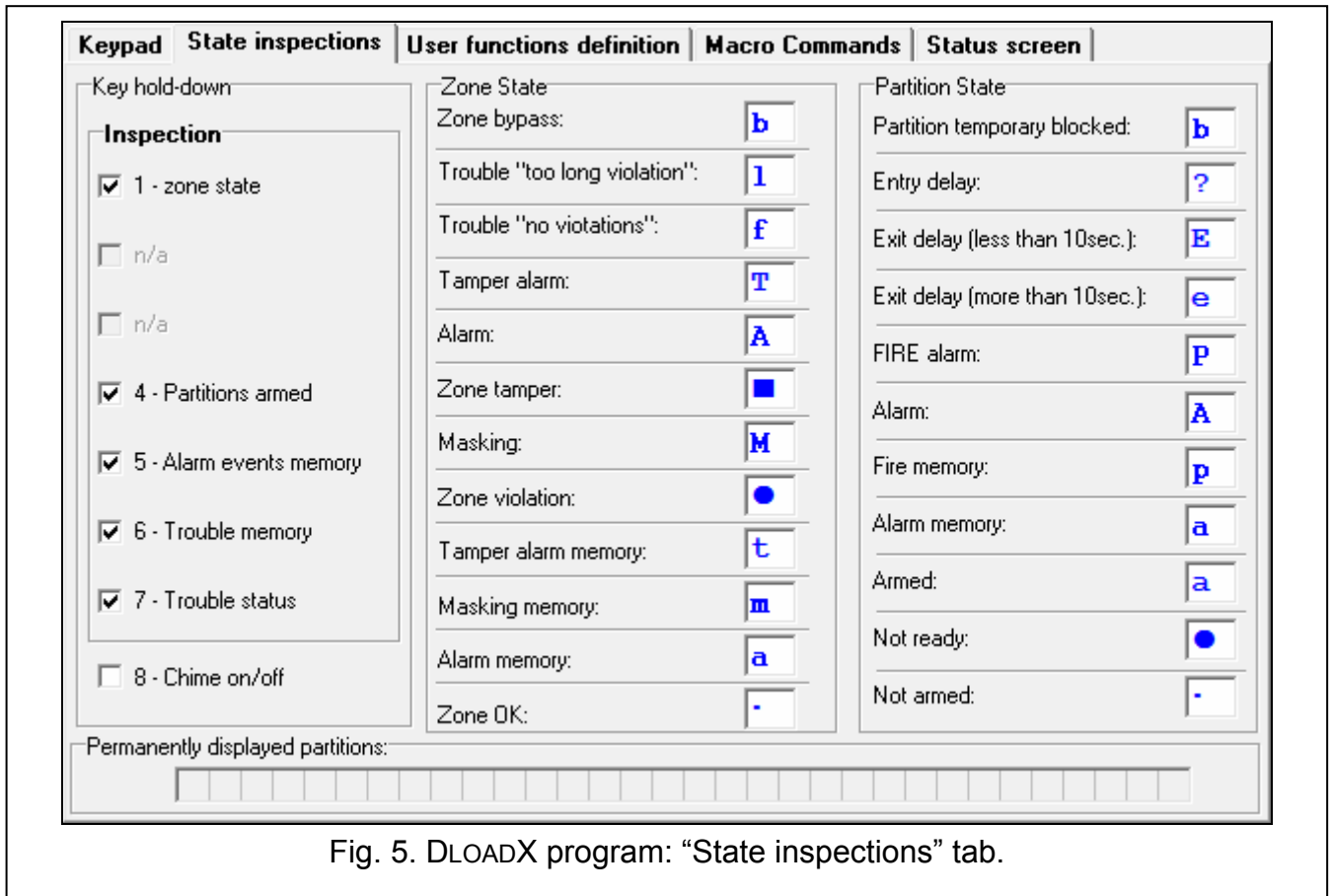





Fig. 5. DLOADX program: "State inspections" tab.



1 – zone state [Zones] – if this option is enabled, you can inspect the zone state without entering the code:

- after tapping  on the "System status" screen,
- after tapping and holding for 3 seconds  on the terminal.



4 – partitions armed [Partitions] – if this option is enabled, you can inspect the partition state without entering the code:

- after tapping  on the "System status" screen,
- after tapping and holding for 3 seconds  on the terminal.



5 – alarm events memory [Alarms log] – if this option is enabled, you can view the alarms log without entering the code:

- after tapping  on the "System status" screen,
- after tapping and holding for 3 seconds  on the terminal.

6 – trouble memory [Troubles log] – if this option is enabled, you can view the troubles log without entering the code:

- after tapping  on the "System status" screen,
- after tapping and holding for 3 seconds  on the terminal.

7 – trouble status [Troubles] – if this option is enabled, you can view the current troubles without entering the code:

- after tapping  on the “System status” screen,
- after tapping and holding for 3 seconds  on the terminal.

8 – chime on/off [Chime changing] – if this option is enabled, the user can switch on/off the CHIME signal in the keypad by means of the terminal, tapping and holding for about 3 seconds  on the terminal.

Zone state [Zone characters] – you can define the symbols which will be used by the terminal to illustrate the state of zones.

Partition state [Part. characters] – you can define the symbols which will be used by the terminal to illustrate the state of partitions.

7.1.3 User functions definition

Code+arrows – you can define which functions will be started on entering the code and tapping the selected arrow key.

7.1.4 Macro commands



The macro commands related data are stored in the keypad memory. Before you start defining the macro commands, click on the “Read” button in the “Macro commands” tab to read the data from the keypad. Having defined the macro commands, click on the “Write” button in the “Macro commands” tab to write the data to the keypad. The

macro command related data are not read / written when you click on the  button in the main menu of DLOADX program.

In the keypad with factory default settings, there are two macro commands defined which are assigned to the first group:

0# – quick full arming (the control panel will only execute the macro command after you define the partitions which are to be armed in the event of quick full arming – see QUICK ARM PARTITIONS p. 7);

9# – exit delay clearing (the control panel will execute the macro command if reducing the exit delay time is allowed by the partition settings and the EXIT DELAY CLEARING ENABLE option is enabled in the keypad – see p. 9).

The “Reset” button in the DLOADX program makes it possible to restore the keypad factory settings, i.e. those related to macro commands, status screen and EOL resistors (in the case of the keypads supported by the INTEGRA Plus control panels, the EOL resistor values are not programmed individually for keypad zones).

Groups

The macro commands which are to be available for the keypad users must be assigned to one of the four groups. Up to 16 macro commands can be assigned to a group. Up to 6 macro command icons can be displayed on the keypad screen at the same time. The DLOADX program presents groups of macro commands and macro commands assigned to them in a tree form.

Name – name of the macro command group which is displayed on the keypad screen under the icon (up to 16 characters in two lines, up to 8 characters in the line). Do not enter the name if it is not to be displayed.

Icon – icon of a group of macro commands. In order to display the list of available icons, click the  button.

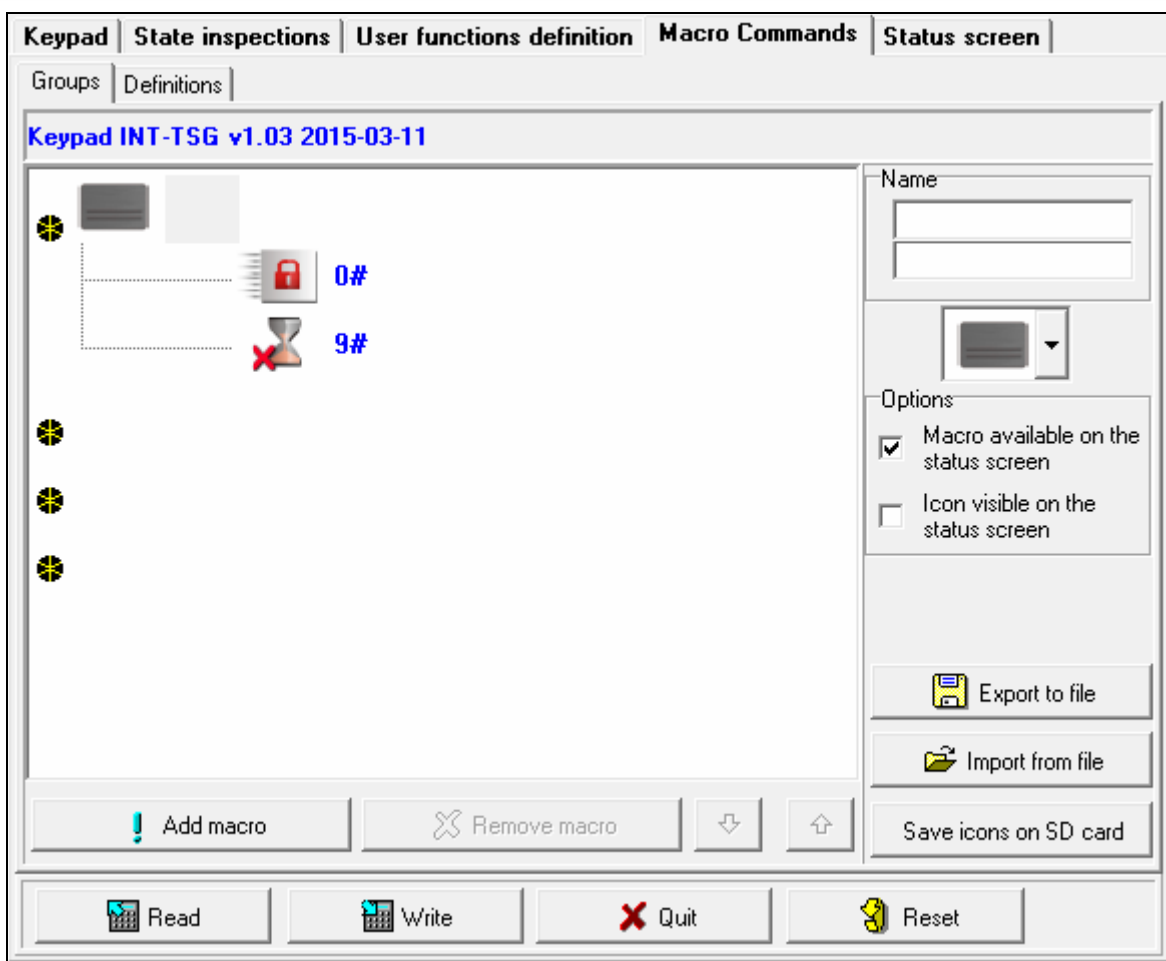

Fig. 6. DLOADX program: “Groups” tab.

Macro available on the status screen – if this option is enabled, the group of macro commands is available from the status screen, i.e. touching a corner of the status screen will display macro commands assigned to that group (1st group of macro commands – upper left corner; 2nd group of macro commands – upper right corner; 3rd group of macro commands – lower left corner; 4th group of macro commands – lower right corner).

Icon visible on the status screen – if this option is enabled, the icon of the group of macro commands is displayed in the corresponding corner of the status screen. The option is available when the MACRO AVAILABLE ON THE STATUS SCREEN option is enabled for the group of macro commands.

Add macro – the button is available after you click on a group of macro commands. It displays a list containing the names of defined macro commands. After you click on a name, the macro command will be added to the group.

Remove macro – the button is available after you click on any macro command. It removes that macro command from the group.



– click to move the highlighted macro command down within the group.



– click to move the highlighted macro command up within the group.

Read – click to read the macro command related data from the keypad.

Write – click to write the macro command related data to the keypad.

Quit – click to cancel reading or writing the macro command related data.

Reset – click to delete all the defined macro commands (and restore factory default settings).

Export to file – click to export defined macro commands to a file. The file with macro commands can be imported to another INT-TSG keypad.

Import from file – click to import macro commands from a file.

Save icons on SD card – click to write icons to the microSD memory card (all icons available in the DLOADX program will be written). The microSD card must be inserted in the computer memory card reader (after clicking the button, indicate the card location).

Definitions

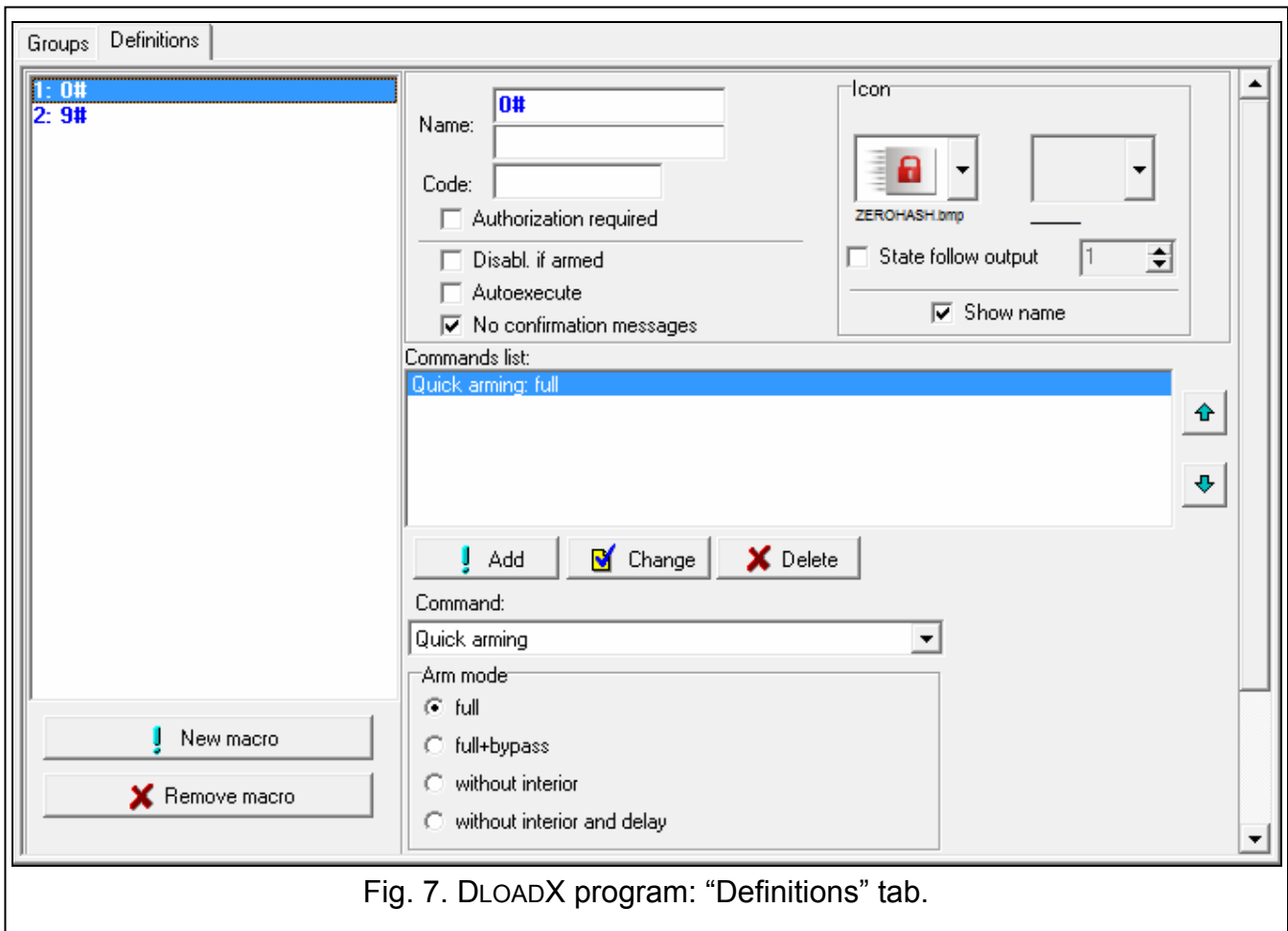

Fig. 7. DLOADX program: “Definitions” tab.

You can create and configure macro commands in the “Definitions” tab. The macro command is a sequence of actions, composed of single commands, which are to be done by the control panel when running the macro command.

New macro – click to create a new macro command.

Remove macro – click to delete selected macro command.

Name – individual name of the macro command (up to 16 characters in two lines, up to 8 characters in the line).

Code – the code which is to be used for authorization when executing commands contained in the macro command. For execution of such commands to be possible, the code must be granted a suitable authority level. It is presented as a string of asterisks.



If, when running a macro command, it turns out that the code is invalid (e.g. it has been changed in the meantime), the user will be able to enter the correct code. It will be automatically saved to the keypad memory (replacing the invalid one).

Authorization required – if this option is enabled, the macro command will only be run after user authorization by using a code. The code entered in the “Code” field will be ignored.

Disabled if armed – if this option is enabled, the macro command will not be available, when any of the partitions operated by the keypad is armed.

Autoexecute – if this option is enabled and the group contains just one macro command, the macro command will run immediately on tapping the icon of macro command group (or the status screen corner, if the MACROS AVAILABLE ON THE STATUS SCREEN option is enabled). If the AUTHORIZATION REQUIRED option is enabled, authorization with code will be necessary.

No confirmation messages – if this option is enabled, no messages will appear to inform you about execution of a command or an error after running a macro command (the screen from which the macro command was run will still be displayed).



Icon – the macro command icon. The list of available icons will be displayed after you click

the  button. If the STATE FOLLOW OUTPUT option is enabled, select 2 icons for the macro commands. One icon will be displayed when the output is inactive, and the other – when the output is active.

State follow output – if this option is enabled, the icon of macro command will change depending on the status of output whose number should be selected in the field on the right side. Select an output, the status of which depends on the actions taken by the control panel after running the macro command. Thus it will be possible to inform the user by means of macro command icons about, for example, the status of outputs controlled by using macro commands or the status of partitions which are armed by a macro command.

Show name – if this option is enabled, the macro command name will be displayed on the keypad below the icon.

Commands list – commands assigned to the currently highlighted macro command. The

 and  buttons allow you to change the order of commands (moving the selected command up and down).

Add – click to add to the list a new command, selected in the “Command” field.

Change – click to save the changes to the command parameters which were made after adding the command to the list (otherwise, the changes made will not be saved).

Delete – click to remove the highlighted command from the list.

Command – the control panel executed function which can be assigned to the macro command. The list of all available functions will be displayed after you click the  button. Depending on which function you choose:

Arming – select the partitions which are to be armed (double-click on the field designated by the partition number) and define the arming mode (next clicks on the field designated by the partition number; the digit inside the field has the following meaning: 0 - fully armed; 1 – fully armed+bypasses; 2 – armed without interior; 3 - armed without interior and without entry delay).

Disarming – select the partitions which are to be disarmed (double-click on the field designated by the partition number).

Alarm clearing – select the partitions in which alarm is to be cleared (double-click on the field designated by the partition number).

Bypass zones – select the zones which are to be inhibited (double-click on the field designated by the zone number).

Unbypass zones – select the zones which are to be unbypassed (double-click on the field designated by the zone number).

Outputs ON – select the outputs which are to be activated (double-click on the field designated by the output number).

Outputs OFF – select the outputs which are to be deactivated (double-click on the field designated by the output number).

Change outputs state – select the outputs whose status is to be changed (double-click on the field designated by the output number).

KNX telegram – program the following parameters of KNX telegram for the INT-KNX module:

INT-KNX module – INT-KNX module which is to send the telegram.

Group address – the group address which will be inserted in the telegram.

Type – the telegram type.

Value – the value that will be inserted in the telegram (parameter available for some types of the telegram).

Priority – telegram priority (if two elements of the bus start transmitting simultaneously, the telegram with higher priority will be sent first).

KNX telegram (v2) – program the following parameters related to setting the value of KNX communication object:

Module INT-KNX – INT-KNX-2 module in which the value is to be set.

Makro Command – name of the VIRTUAL (MACRO) type object, defined in INT-KNX-2 module.

Data type – size and meaning of the communication object data defined in INT-KNX-2 module for selected object.

Value – value to be set (if the type of data provides for sending a sequence of characters, you can enter up to 13 characters).

Exit delay clearing (no additional parameters to configure).

Quick arm – select the arming mode which is to be activated.



The partitions must be controlled by user code.

The zones must not have the BYPASS DISABLED option enabled.

The outputs must be the 24. MONO SWITCH, 25. BI SWITCH, 105. SHUTTER UP, 106. SHUTTER DOWN or REMOTE SWITCH type (they need not be assigned to any group of outputs).

The keypad can be used to control the KNX system, if the INT-KNX or INT-KNX-2 module is connected to the control panel.

Defining the macro commands

1. Click on the “Read” button to read the macro command related data from the keypad.
2. Click the “Definitions” tab.
3. Click the “New macro” button. A new macro command will appear in the list.
4. Enter a name for the new macro command.
5. If the macro command name is to be displayed on the keypad, enable the SHOW NAME option.
6. If the macro command is to be run without entering the code by the user, enter the code with a suitable authority level.
7. If running the macro command is to be each time preceded by user authorization, enable the AUTHORIZATION REQUIRED option.

8. If the macro command is not to be available, when any of the partitions operated by the keypad is armed, enable the DISABLED IF ARMED option.
9. If the macro command is to be run instantly on tapping the icon of macro command group, enable the AUTOEXECUTE option (if so, only this single macro command is to be assigned to the group).
10. If the confirmation messages are not to be displayed after running the macro command, enable the NO CONFIRMATION MESSAGES option.
11. Select the icon which will be used to present the macro command on the keypad.
12. If the icon is to present the status of selected output:
 - enable the STATE FOLLOW OUTPUT option;
 - indicate the output number;
 - select the icons which will illustrate inactive and active status of the output.
13. Click on the  button in the “Command” field and select from the list the function the new macro command is to execute.
14. Program the command parameters as required.
15. Click the “Add” button. A new command will appear in the list of commands assigned to the macro command. After clicking the command you can still make a correction of its parameters. After making the changes, click the “Change” button.
16. Repeat the steps 13-15, if you want to add next commands.
17. Click the “Groups” tab.
18. Click the group to be edited.
19. Enter the group name, if it is to be displayed on the keypad.
20. Select the icon which will be used to present the group of macro commands on the keypad.
21. Enable the MACRO AVAILABLE ON THE STATUS SCREEN option for the group, if macro commands assigned to the group are to be displayed after touching a corner of the status screen.
22. Enable the ICON VISIBLE ON THE STATUS SCREEN option for the group, if the group icon is to be displayed in a corner of the status screen.
23. Click the “Add macro” button. A list of all defined macro commands will be displayed.
24. Click on a macro command to add it to the group. The macro command will be put in the tree under the group.
25. Click on the “Write” button to write the macro command related data to the keypad.

7.1.5 Status screen



The status screen related data are stored in the keypad memory. Before you start configuring the status screen, click on the “Read” button in the “Status screen” tab to read the data from the keypad. Having configured the status screen, click on the “Write” button in the “Status screen” tab to write the data to the keypad. The status

screen related data are not read / written when you click on the  button in the main menu of DLOADX program.

If the ICON VISIBLE ON THE STATUS SCREEN option is enabled for a group of macro commands, do not place any elements in the screen corner where the icon will be displayed, or they will be covered by the icon. The DLOADX program indicates using appropriate graphic symbols the screen corners where the icons will be displayed.

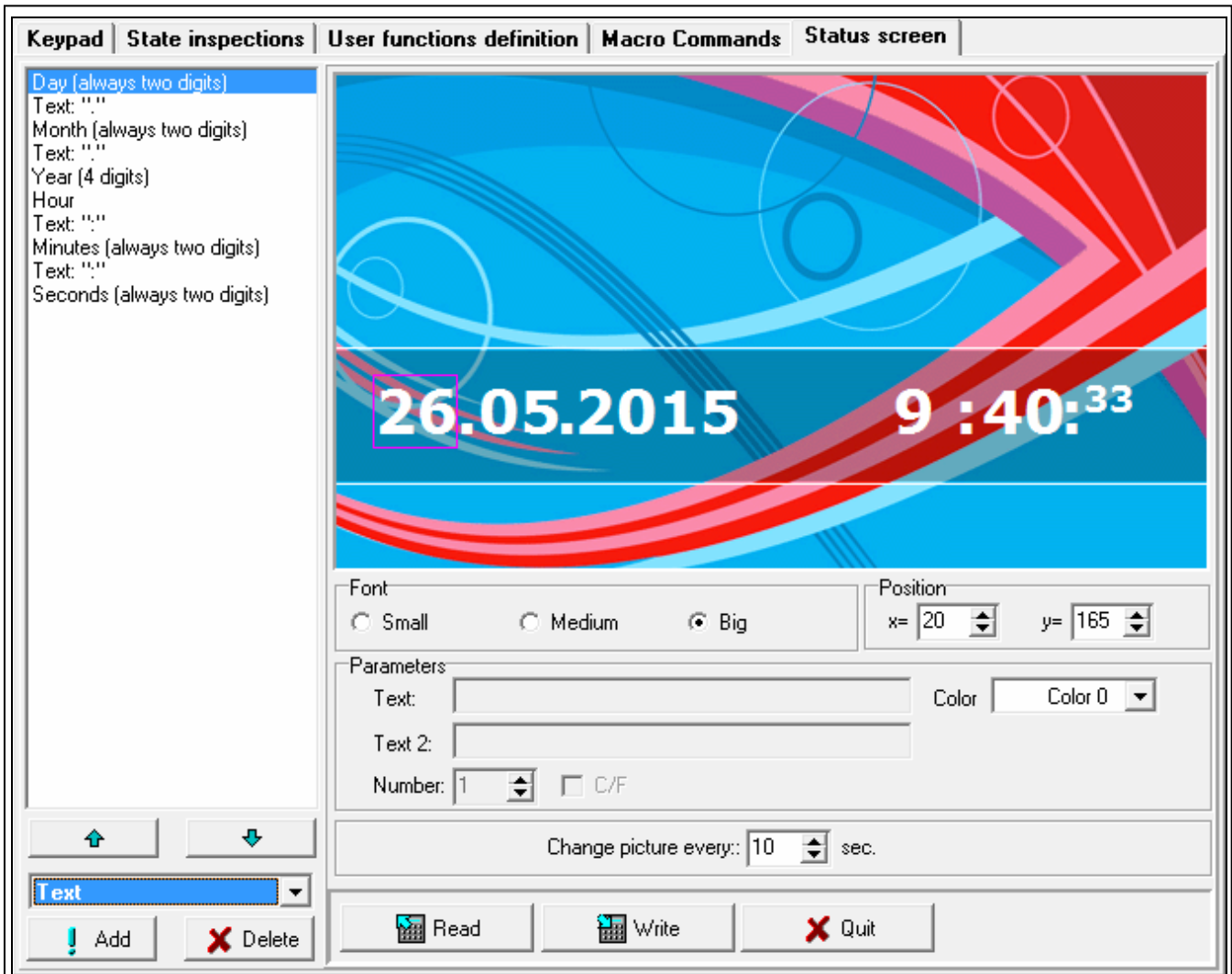

Fig. 8. DLOADX program: "Status screen" tab (keypad connected to INTEGRA / INTEGRA Plus control panel).

The status screen is displayed automatically after the keypad is idle for 60 seconds. This rule does not apply if the terminal is running. In such a case, the status screen may be displayed later or even will not be displayed at all (e.g. when the service menu is open). The following information can be displayed on the status screen:

- any text defined by the installer,
- partition status by means of symbols (select individual partitions whose status will be displayed),
- zone status by means of symbols (select individual zones whose status will be displayed),
- output status by means of symbols (select individual outputs whose status will be displayed),
- temperature (indicate the control panel zone to which the temperature detector is assigned, and define whether the temperature is to be displayed in Celsius or Fahrenheit degrees),
- date and time (particular elements, such as day, month, year, hour, minutes and seconds are to be configured individually),
- keypad name,

- zone status by means of messages (select individual zones whose status will be displayed, and define the content and color of messages for normal state and for violation, because only these two states are presented in the form of message),
- output status by means of messages (select individual outputs whose status will be displayed, and define the content and color of messages for active and inactive output).

There are three font sizes available for use on the status screen. You can also define color of the font to be used. Using the “drag and drop” method, you can easily select the place where the given information will be presented on the display.

Slide show

The keypad can display a slide show (as the status screen background and after 10 minutes of the keypad inactivity). The photos to be displayed should be stored on a microSD memory. Their size should not exceed 480 x 272 pixels. Only images in BMP format are supported. The CHANGE PICTURE EVERY parameter defines how fast the images will be changed during the slide show. If the time equal to 0 is programmed, no slide show will be displayed. If this is the case, the first picture stored on the microSD card will be displayed as the status screen wallpaper.

7.1.6 End-of-line resistance



The resistance data are stored in the keypad. Before you start programming the resistor values, click on the “Read” button in the “EOL resistance value” tab to read the data from the keypad. Having programmed the resistor values, click on the “Write” button in the “EOL resistance value” tab to write the data to the keypad. The EOL

resistors related data are not read / written when you click on the  button in the main menu of DLOADX program.

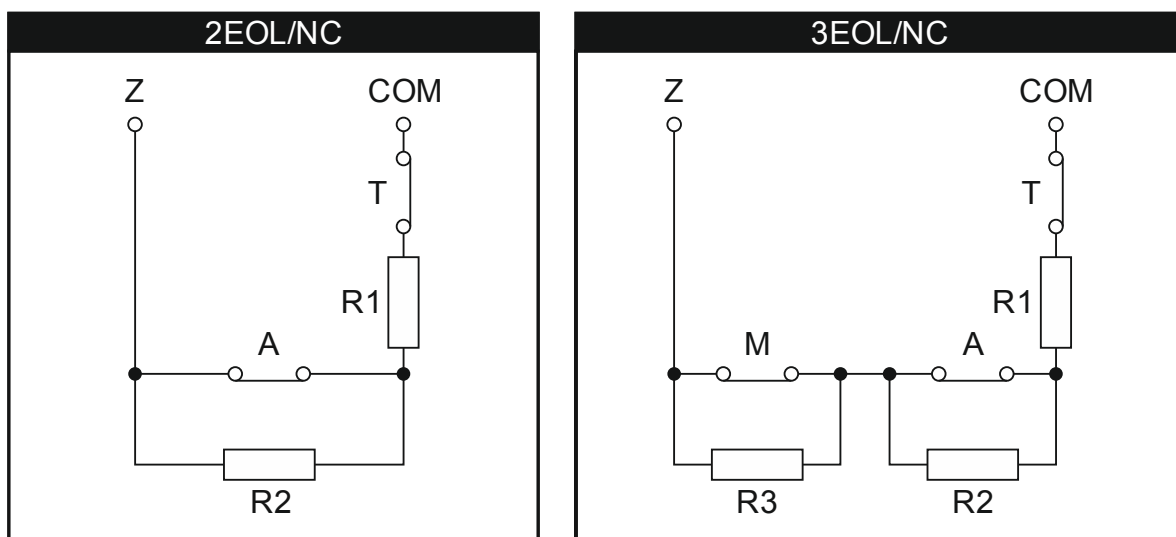

Fig. 9. Numbering of EOL resistors (same for the NO detector).

T – tamper. A – alarm. M – masking.

The value of EOL resistors is programmable. Depending on the control panel to which the keypad is connected:

INTEGRA: parameters of the EOL resistors should be defined for zones in a single keypad. Value of the resistors R1 and R2 is to be programmed (numbering of the resistors is shown in Fig 9). You can enter values from 500 Ω to 15 k Ω . The total resistance (R1+R2) may not exceed 15 k Ω . For the R2 resistor, you can program value 0. In such a case, the value of resistors used in the Double EOL configuration must be equal to half the value

programmed for the R1 resistor (the value of one resistor must not be less than 500 Ω). By default, the following values are programmed:

R1 = 1,1 k Ω ;

R2 = 1,1 k Ω .

The resistor value for Single EOL configuration is the sum of R1 and R2 resistors.

INTEGRA Plus: parameters of the EOL resistors should be defined for the mainboard zones.

The same parameters will be set automatically for the zones in keypads in which the value of EOL resistors is programmable. Therefore, the “EOL resistance value” tab is not available.

7.2 Keypad connected to VERSA / VERSA Plus control panel

To configure the keypad settings, you can use:

- DLOADX program: →“Versa – Structure” window →“Hardware” tab →“Expanders” branch →*[keypad name]*. The DLOADX program alone makes it possible to configure all the settings.
- keypad: ►SERVICE MODE ►2. HARDWARE ►1. KPDS. & EXPS. ►2. SETTINGS ►*[keypad name]*. How to enter the service mode, refer to the section on programming the keypad address by means of the service function (p. 5).

7.2.1 Parameters and options

Shown in square brackets are the names displayed on keypads.

Name – individual name of the keypad (up to 16 characters).

Tamper signaled in part. [Tamper in p.] – partition where alarm will be triggered in the event of keypad tamper (opening the enclosure or disconnecting the keypad from the bus).

CHIME signal of zones [Zone chime] – the keypad can audibly signal violation of selected zones. If the zone is armed, violation will not trigger the CHIME signal.

Date/Time format – the way how date and time will be presented on the display.

Options

Sign. entry delay [Entry time sign.] – if this option is enabled, the keypad will audibly signal the entry delay countdown.

Sign. exit delay [Exit time sign.] – if this option is enabled, the keypad will audibly signal the exit delay countdown.

Sign. alarms [Alarm signalling] – if this option is enabled, the keypad will signal the alarms audibly.

Quick arming – Partition 1 [Part.1 QuickArm] – if this option is enabled, partition 1 can be armed without entering the code.

Quick arming – Partition 2 [Part.2 QuickArm] – if this option is enabled, partition 2 can be armed without entering the code.

Keys sound – with this option enabled, pressing the keypad keys is confirmed by beeps.

Sign. trbl in part. arm [Trbl.in part.arm] – if this option is enabled, the  LED goes off after both partitions are fully armed (if the option is disabled, the LED goes off after just one of the partitions is armed in any mode).

Show code entering [Code entry ind.] – if this option is enabled, entering the code is presented on the keypad display by asterisks.

Chime on/off – if this option is enabled, the chime signal can be turned on/off after tapping and holding for 3 seconds  on terminal.

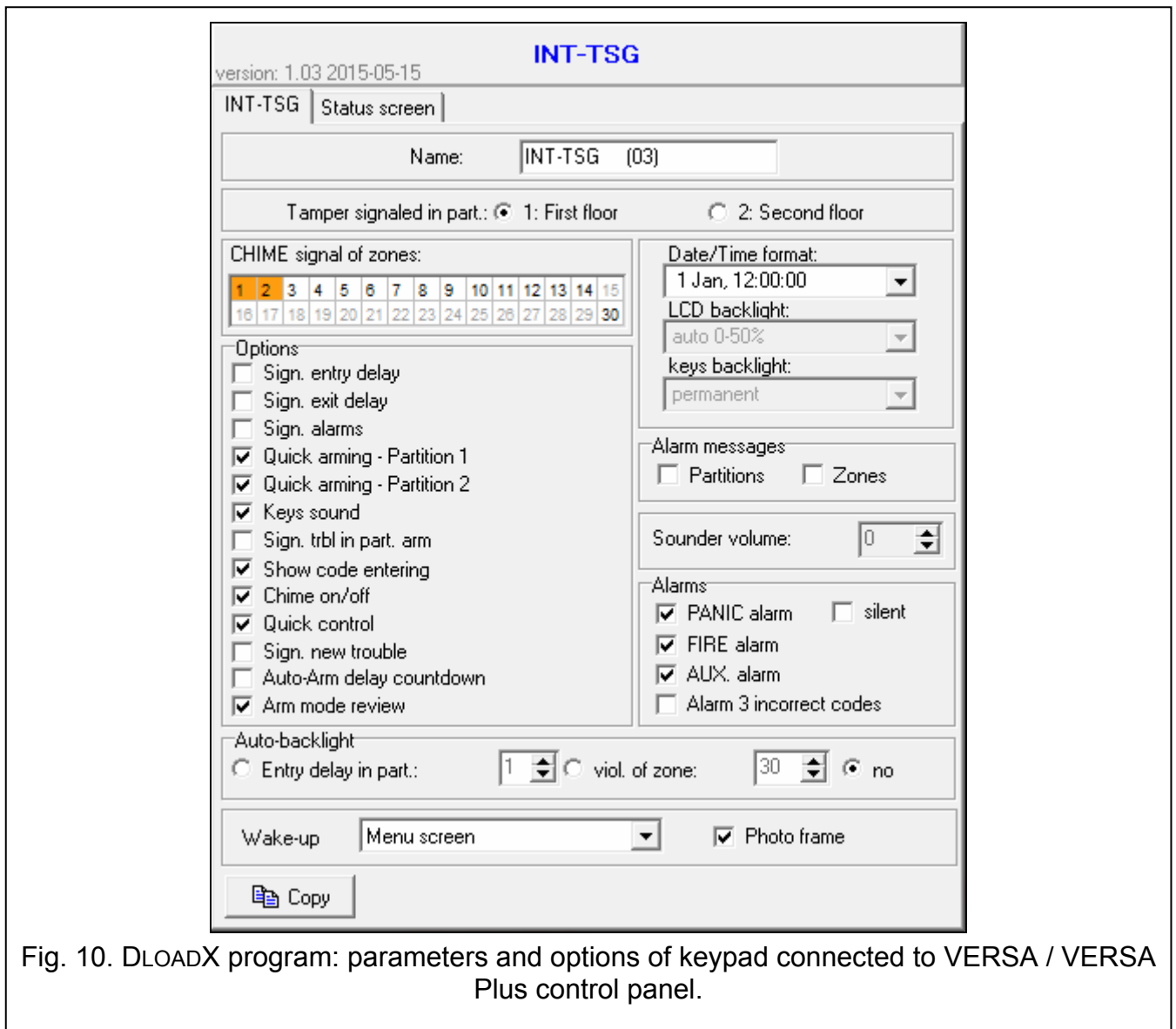



Fig. 10. DLOADX program: parameters and options of keypad connected to VERSA / VERSA Plus control panel.

Quick control – if this option is enabled, you can control the outputs without entering the code:

- after tapping  on the main screen,
- using the keys designated by numbers on terminal. When programming the control panel, assign the 15. CONTROLLED outputs to the keys (see the control panel programming manual).

Sign. new trouble [New trbl.signal.] – if this option is enabled, the keypad will audibly signal occurrence of any new trouble (additionally, the TROUBLE MEMORY UNTIL REVIEW option must be enabled in the control panel – see: control panel programming manual). The signaling will be turned off after reviewing the trouble with the 7. SYSTEM STATE user function.

Auto-Arm delay countdown [Autoarm signal.] – if this option is enabled, the auto-arm delay countdown is signaled acoustically.

Arm mode review [Arm mode check.] – if this option is enabled, you can inspect the partition state without entering the code:

- after tapping  on the “System status” screen,

- after tapping and holding for 3 seconds  on the terminal.



Alarm messages

Partitions [Part.alarm msg.] – if this option is enabled, messages on partition alarms will be displayed (they contain the name of partition).

Zones [Zone alarm msg.] – if this option is enabled, messages on alarms from zones will be displayed (they contain the name of zone). The zone alarm messages have the priority.



Alarms

PANIC alarm – if this option is enabled, you can trigger panic alarm from the keypad by tapping and holding for 3 seconds:



-  on the “Emergency” screen,
-  on the terminal.

silent [Silent panic] – if this option is enabled, the panic alarm triggered from the keypad will be a silent one (without loud signal). Additionally, the silent panic alarm can be triggered by tapping and holding any part of the status screen for about 3 seconds. The option is available, if the PANIC ALARM option is enabled.

FIRE alarm – if this option is enabled, you can trigger fire alarm from the keypad by tapping and holding for 3 seconds:

-  on the “Emergency” screen,
-  on the terminal.

AUX. alarm [Medical alarm] – if this option is enabled, you can trigger medical alarm from the keypad by tapping and holding for 3 seconds:

-  on the “Emergency” screen,
-  on the terminal.

Alarm 3 incorrect codes [3 wrong codes] – if this option is enabled, entering incorrect code three times will trigger the alarm.

Auto-backlight

The keypad can be woken up after occurrence of a specified event in the system: starting the entry delay countdown in a selected partition, or violating a selected zone.

Wake-up

You can define how the keypad will respond to the wake-up (after a tap on the screen by the user or occurrence of a specified event in the system):

Status screen – status screen will be displayed.

Menu screen – main screen will be displayed.

Disarming – if at least one partition managed by the keypad is armed, the authorization screen will be displayed (after entering the code and tapping , and depending on the system state: the partition(s) will be disarmed / partition selection screen will be displayed / “Alarm clearing / Disarming” screen will be displayed). If none of the partitions is armed, the main screen will be displayed.

Photo frame – if this option is enabled, the following will be displayed after 10 minutes of keypad inactivity:



slide show – if there are at least two pictures on the memory card and the value of CHANGE PICTURE EVERY parameter is different from 0,

clock – if there are one or no pictures on the memory card or the value of CHANGE PICTURE EVERY parameter is 0.

If this option is disabled, the screen will go blank after 10 minutes of keypad inactivity.

7.2.2 Status screen



The status screen related data are stored in the keypad memory. Before you start configuring the status screen, click on the “Read” button in the “Status screen” tab to read the data from the keypad. Having configured the status screen, click on the “Write” button in the “Status screen” tab to write the data to the keypad. The status screen related data are not read after clicking on the  button or saved after clicking on the  button in the DLOADX program main menu.

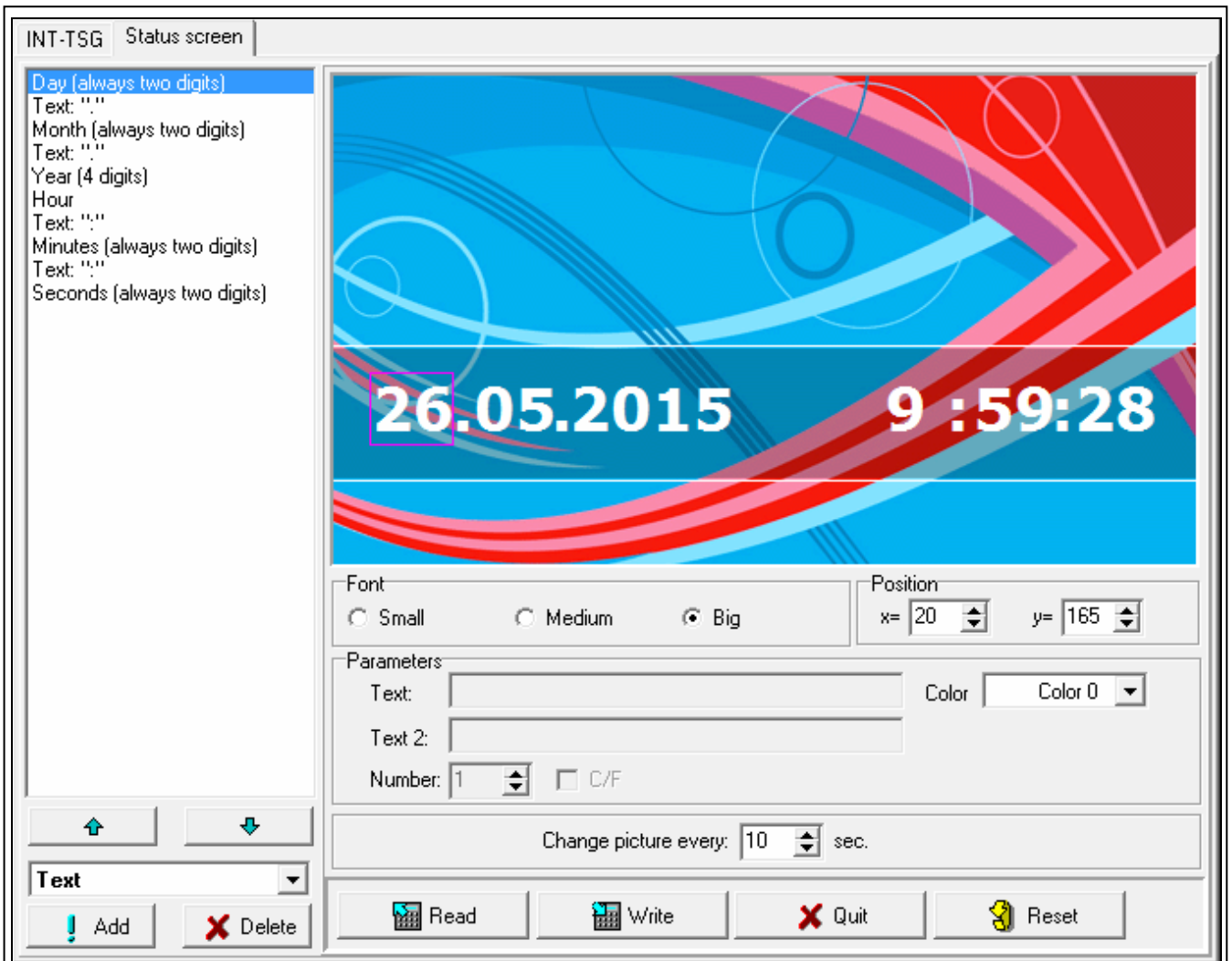

Fig. 11. DLOADX program: “Status screen” tab (keypad connected to VERSA / VERSA Plus control panel).

The status screen is displayed automatically after the keypad is idle for 60 seconds. This rule does not apply if the terminal is running. In such a case, the status screen may be displayed

later or even will not be displayed at all (e.g. when the service menu is open). The following information can be displayed on the status screen:









- any text defined by the installer,
- partition status by means of symbols (select individual partitions whose status will be displayed),
- zone status by means of symbols (select individual zones whose status will be displayed),
- output status by means of symbols (select individual outputs whose status will be displayed),
- date and time (particular elements, such as day, month, year, hour, minutes and seconds are to be configured individually),
- keypad name,
- zone status by means of messages (select individual zones whose status will be displayed, and define the content and color of messages for normal state and for violation, because only these two states are presented in the form of message),
- output status by means of messages (select individual outputs whose status will be displayed, and define the content and color of messages for active and inactive output).





There are three font sizes available for use on the status screen. You can also define color of the font to be used. Using the “drag and drop” method, you can easily select the place where the given information will be presented on the display.

Slide show

The keypad can display a slide show (as the status screen background and after 10 minutes of the keypad inactivity). The photos to be displayed should be stored on a microSD memory. Their size should not exceed 480 x 272 pixels. Only images in BMP format are supported. The CHANGE PICTURE EVERY parameter defines how fast the images will be changed during the slide show. If the time equal to 0 is programmed, no slide show will be displayed. If this is the case, the first picture stored on the microSD card will be displayed as the status screen wallpaper.

8. Updating the keypad firmware

1. Write the file with new version of firmware to a microSD card.
2. Tap  on the main screen. The “Advanced” screen will be displayed.
3. Tap . The terminal will be displayed.
4. Enter the **service code** (by default: 12345) and tap . The user menu will be displayed.
5. Start the service mode:
 - INTEGRA / INTEGRA Plus: tap , .
 - VERSA / VERSA Plus: tap in turn , , .
6. Hide the service mode:
 - INTEGRA / INTEGRA Plus: start the HIDE SM NOW function (▶SM SETTINGS ▶HIDE SM NOW) (▶SM SETTINGS ▶HIDE SM NOW),
 - VERSA / VERSA Plus: start the A. HIDE SM NOW function (▶0. SRVMOD CONFIG ▶A. HIDE SM NOW).
7. The status screen will be displayed.

8. Open the keypad enclosure and insert the microSD card into its slot.
9. Tap  icon on the main screen. The “Advanced” screen will be displayed.
10. Tap  . The authorization screen will be displayed.
11. Enter the service code and tap . The update screen will be displayed.
12. Within 10 seconds, tap any part of the screen to start the firmware updating (if you do not tap the screen, the firmware will not be updated, but the file with the new firmware version will be erased from the microSD card and the keypad restart will follow).
13. After completion of the firmware updating, the file with the new firmware version will be erased from the microSD card and the keypad restart will follow.
14. Having closed the keypad enclosure, you can exit the service mode (repeat the steps 2-5, and then tap ).



You can update the keypad firmware without using the menu. To do so, turn off the keypad power, insert the microSD card with new firmware version into the slot and turn on the keypad power again. The update screen will be displayed.

9. Specifications

Supply voltage	12 V DC ±15%
Standby current consumption	250 mA
Maximum current consumption	265 mA
Supported memory cards.....	microSD, micro SDHC
Environmental class according to EN50130-5	II
Working temperature range	-10°C...+55°C
Maximum humidity	93±3%
Enclosure dimensions (width x height x thickness).....	120 x 92 x 14 mm
Weight.....	165 g

10. Manual update history

Manual version	The list of changes
02/14	<ul style="list-style-type: none"> • Information on the required version of DLOADX program has been modified (p. 2). • Information on the enclosure opening tool has been added (p. 2). • Description of some keypad parameters and options has been modified (p. 7). • Description of "LCD backlight" parameter has been removed (the parameter is not available, because the user can control the intensity of screen backlight). • Description of "Name" parameter for groups of macro commands has been modified (p. 12). • Description of "Macro available on the status screen" option has been added (p. 13). • Description of "Icon visible on the status screen" option has been added (p. 13). • Description of "Name" parameter for macro commands has been modified (p. 14). • Description of macro command defining procedure has been modified (p. 16). • Note on placing elements on the status screen in connection with the option to display icons of macro command groups on status screen has been added (p. 17).
05/15	<ul style="list-style-type: none"> • Restructuring the entire manual in connection with the keypad ability to interface with VERSA and VERSA Plus control panels.