

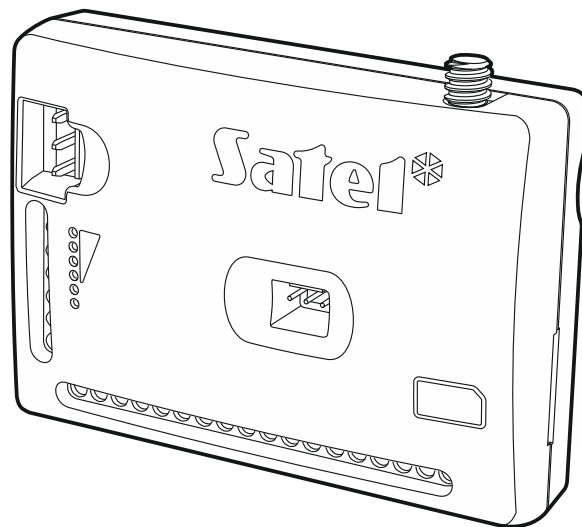

GPRS-A

Universal monitoring module



Firmware version 1.02

gprs-a_en 08/18

SATEL sp. z o.o. • ul. Budowlanych 66 • 80-298 Gdańsk • POLAND
tel. +48 58 320 94 00
www.satel.eu

IMPORTANT

The module should be installed by qualified personnel.

Prior to installation, please read carefully this manual in order to avoid mistakes that can lead to malfunction or even damage to the equipment.

Disconnect power before making any electrical connections.

Changes, modifications or repairs not authorized by the manufacturer shall void your rights under the warranty.

The name plate of the device is located on the enclosure base.

FreeRTOS is used in this device (www.freertos.org).

SATEL's goal is to continually upgrade the quality of its products, which may result in some changes of their technical specifications and firmware. The current information on the introduced modifications is available on our website.

Please visit us:
<http://www.satel.eu>

Hereby, SATEL sp. z o.o., declares that this device is in compliance with the essential requirements and other relevant provisions of Directive 2014/53/EU. The declaration of conformity may be consulted at www.satel.eu/ce

The following symbols may be used in this manual:



- note,



- caution.

Changes made to the firmware version 1.02

Answer to CLIP	Option to send SMS message with 1-Wire sensor status in reply to CLIP.
1-Wire sensors	Option to define a value by which the sensor recorded temperature will be corrected.
Outputs	A new way of output control: "Follow input".
Station simulation	Simulation of the monitoring station can be enabled / disabled. Information about current handling of the telephone line output can be presented in the GX Soft program.
Messaging	A prefix can be added before SMS/push messages. SMS and CLIP can be used for sending notifications at the same time.
IoT	Option to send a "MQTT" and "JSON" protocol frame after the state of inputs/1-Wire sensors has been changed. Option to send a "MQTT" and "JSON" protocol frame after the state of outputs has been changed. Option to define the frame content for "MQTT" and "JSON" protocols.

CONTENTS

1. Introduction	4
2. Features	4
3. Typical module applications.....	6
3.1 Supervision / control of devices.....	6
3.2 Simulation of monitoring station	7
3.3 Work within Internet of Things (IoT)	7
4. Description of the module	8
4.1 LED indicator	9
5. Installation	9
5.1 Preparing the cabling.....	10
5.2 Installation of the module.....	10
5.3 Installation of antenna	10
5.4 Connecting the alarm control panel.....	10
5.5 Connecting the devices to the inputs and outputs.....	10
5.6 Connecting the digital temperature sensors (1-Wire).....	11
5.7 Connecting the power supply and starting the module.....	11
5.8 Connecting the computer to the module.....	12
5.9 Installing the SIM card	12
6. Configuring	12
6.1 Description of the GX Soft program.....	12
6.1.1 Menu bar in the GX Soft program	13
6.1.2 Side menu	14
6.1.3 Additional menu.....	15
6.2 Establishing connection between the program and the module	18
6.2.1 Local connection	18
6.2.2 Remote connection: SATEL server.....	18
6.2.3 Remote connection: Module>>GX Soft.....	18
6.3 Project	19
6.4 Data.....	20
6.5 Hardware	20
6.5.1 Mainboard	20
6.5.2 GSM	22
6.6 Inputs.....	23
6.6.1 State	23
6.6.2 Settings	24
6.6.3 Scaling.....	26
6.6.4 Blocking.....	26
6.7 1-Wire sensors	26
6.7.1 State	26
6.7.2 Settings	27
6.8 Outputs.....	28
6.8.1 Control.....	28
6.8.2 Settings	28
6.8.3 Triggering	29
6.9 Communication.....	29
6.9.1 SATEL server	30
6.9.2 Direct connection to GX Soft.....	30
6.10 Station simulation	31
6.11 Reporting	32
6.12 Messaging	36
6.13 Event converter	38
6.14 SMS control	39
6.15 CLIP control.....	40
6.16 Remote update	42
6.17 IoT	43
6.18 Users	45
6.19 Events.....	45

7. GX Control application.....	46
8. Control by using a telephone.....	48
8.1 SMS control	48
8.2 CLIP control	49
9. Module firmware update	49
9.1 Local update	50
9.2 Remote update	50
9.2.1 Initiating the update by using SMS message.....	50
10. Restoring the factory settings	50
11. Specifications	50
12. Appendix	51
12.1 Data format for JSON and MQTT protocol	51
12.1.1 Format of frame sent by the module	51
12.1.2 Format of the module control frame	51
12.2 Table of MODBUS RTU protocol registers	52
13. Manual update history	54

1. Introduction

This manual describes the GPRS-A module and how it should be installed as well as configured using the GX Soft program.

2. Features

Communication

- Built-in GSM telephone designed for use in the 850 / 900 / 1800 / 1900 MHz cellular networks.
- Possibility to remotely check the account balance and validity of the SIM card installed in the module.
- Possibility to define the MCC / MNC code of the operator of network into which the module is to log in.

Reporting

- Reporting events to two monitoring stations.
- Several communication formats:
 - SIA,
 - Contact ID (CID),
 - Ademco Express,
 - Sil. Knight / Ademco slow,
 - Radionics 1400Hz,
 - Radionics 1400 with parity.
- Two transmission paths:
 - GPRS,
 - SMS messages.
- Defining priority for the paths of event reporting.
- Converting and retransmitting codes of events received from the control panel (simulation of telephone monitoring station).

Messaging

- Notification of events related to the module and received from other devices.
- 8 telephone numbers to be notified.
- Notification by using:
 - SMS messages,
 - push messages (provided that GX Control application is installed on the user phone),
 - CLIP (toll-free).

Event log

- Capability of storing up to 500 events generated by the module or received from the control panel.

Inputs

- 8 inputs, programmable as:
 - digital, NO type,

- digital, NC type,
- analog (voltage measurement 0...16.56 V).
- Input for supervision of AC voltage presence.
- Supervising the state of external devices.
- Input blocking capability.

Outputs

- 4 programmable outputs:
 - 2 OC type outputs,
 - 2 NO type relay outputs.
- Controlling external devices or signaling troubles.

1-Wire bus

- Support for up to 8 1-Wire digital temperature sensors.

Control

- Control of outputs or blocking of the module inputs by means of:
 - inputs,
 - SMS messages,
 - GX Soft program,
 - GX Control application,
 - CLIP (only outputs control).
- Possibility of blocking the 1-Wire sensors from GX Soft program and GX Control application.
- Capability of determining the telephone numbers authorized for SMS or CLIP control.

Work within the Internet of Things (IoT)

- Possibility of integrating the module with automation systems, measuring data acquisition systems, etc.

Operation from mobile devices

- Free GX Control application for remote operation of the module.
- Functions available from the application:
 - checking the state of inputs and outputs,
 - blocking / unblocking inputs,
 - blocking / unblocking 1-Wire detectors,
 - output control,
 - viewing troubles,
 - viewing event log.
- Simple and easy establishing remote communication between GX Control application and the module thanks to SATEL's connection setup service.

Configuring

- Free GX Soft program for local (RS-232 (TTL) port) and remote (GPRS) configuring of the module.
- Simple and easy establishing remote communication between GX Soft program and the module thanks to SATEL's connection setup service.

- Possibility to configure the module settings by using SMS messages.

Firmware update

- Local firmware update by using a computer connected to RS-232 (TTL) port.
- Remote update of the module firmware by using the “UpServ” server via GPRS.

LEDs

- LEDs indicating the module status.

Power supply

- Powering with 12 V DC ($\pm 15\%$).
- Connector for SATEL's dedicated power supply unit.

3. Typical module applications

The extended functionality of GPRS-A module enables it to be used for a variety of applications. This section presents typical examples of its application. Some of them are capable of being combined with one other.

3.1 Supervision / control of devices

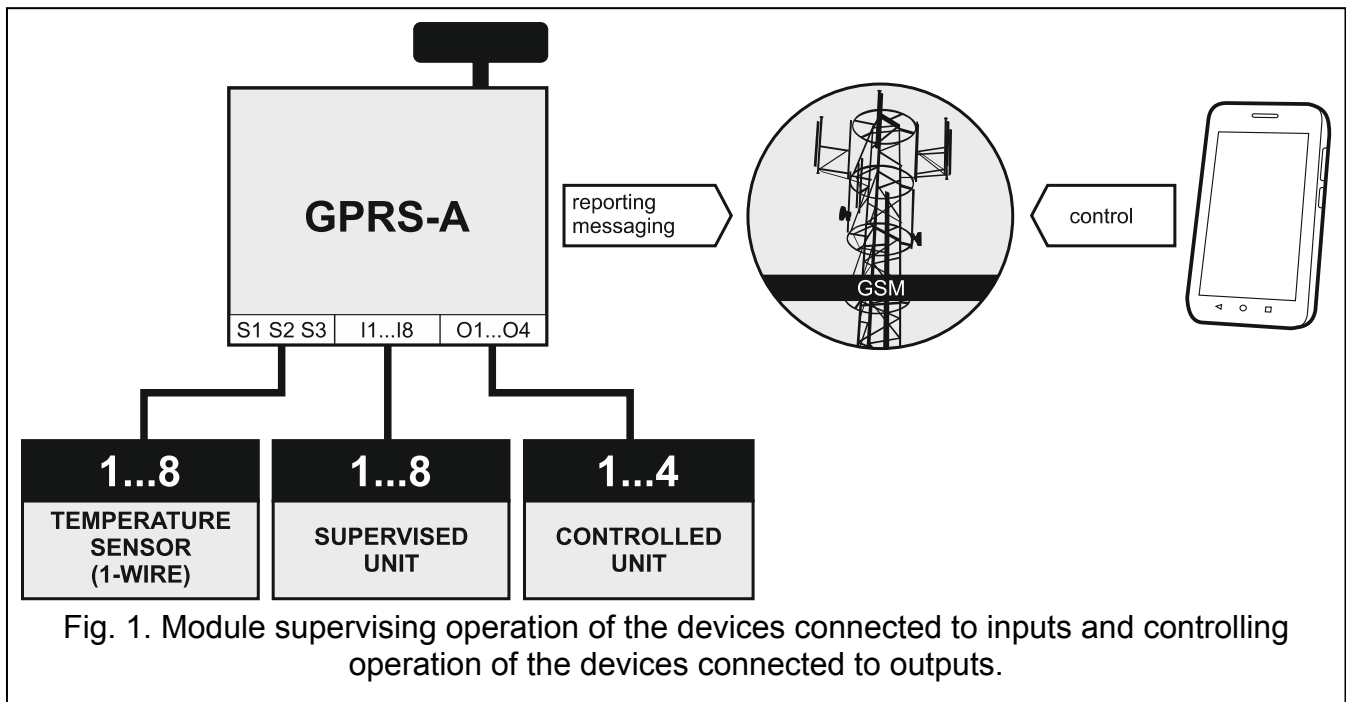

Fig. 1. Module supervising operation of the devices connected to inputs and controlling operation of the devices connected to outputs.

Changing the input state / exceeding the defined threshold limit value may result in:

- sending event code to the monitoring station (reporting GPRS / SMS),
- notification (messaging) about the event by means of SMS, push or CLIP.

The inputs can be blocked locally (by means of one of the module inputs or the GX Soft program) or remotely (by means of SMS messages, the GX Soft program or the GX Control application).

1-Wire sensors can be blocked from GX Soft program or GX Control app.

The devices connected to the module outputs can be controlled locally (by means of module inputs or the GX Soft program) or remotely (by means of SMS messages, CLIP, the GX Soft program or the GX Control application).

3.2 Simulation of monitoring station

The module can forward the event codes received from the control panel to the monitoring station by means of GSM network. Which reporting path will be used to send the event code depends on the module configuration.

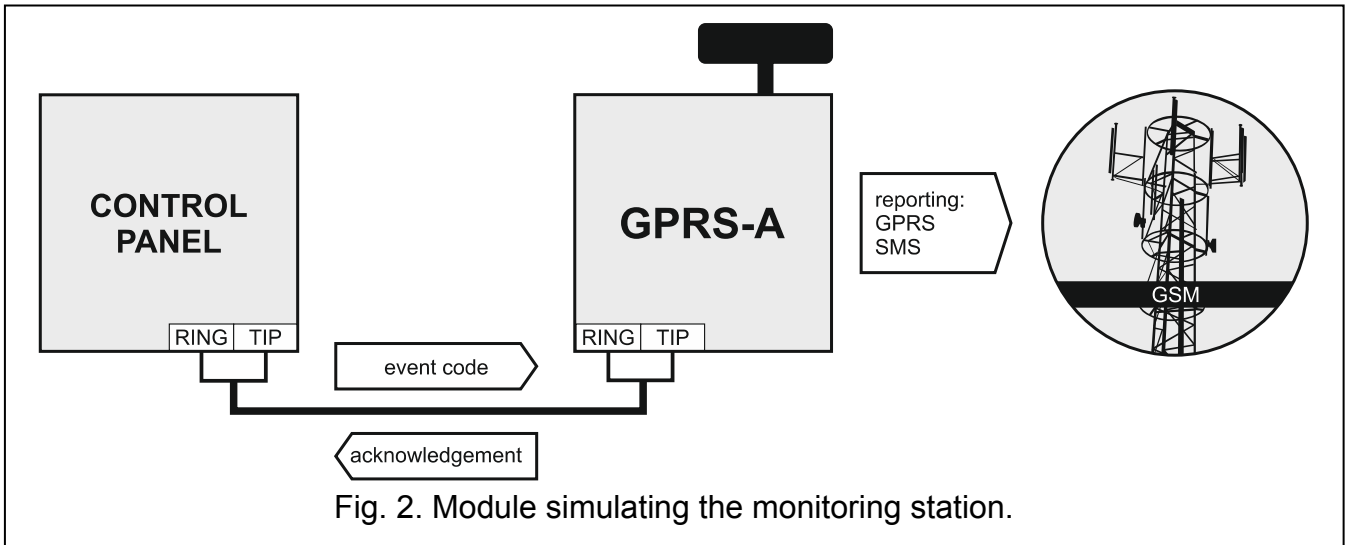

3.3 Work within Internet of Things (IoT)

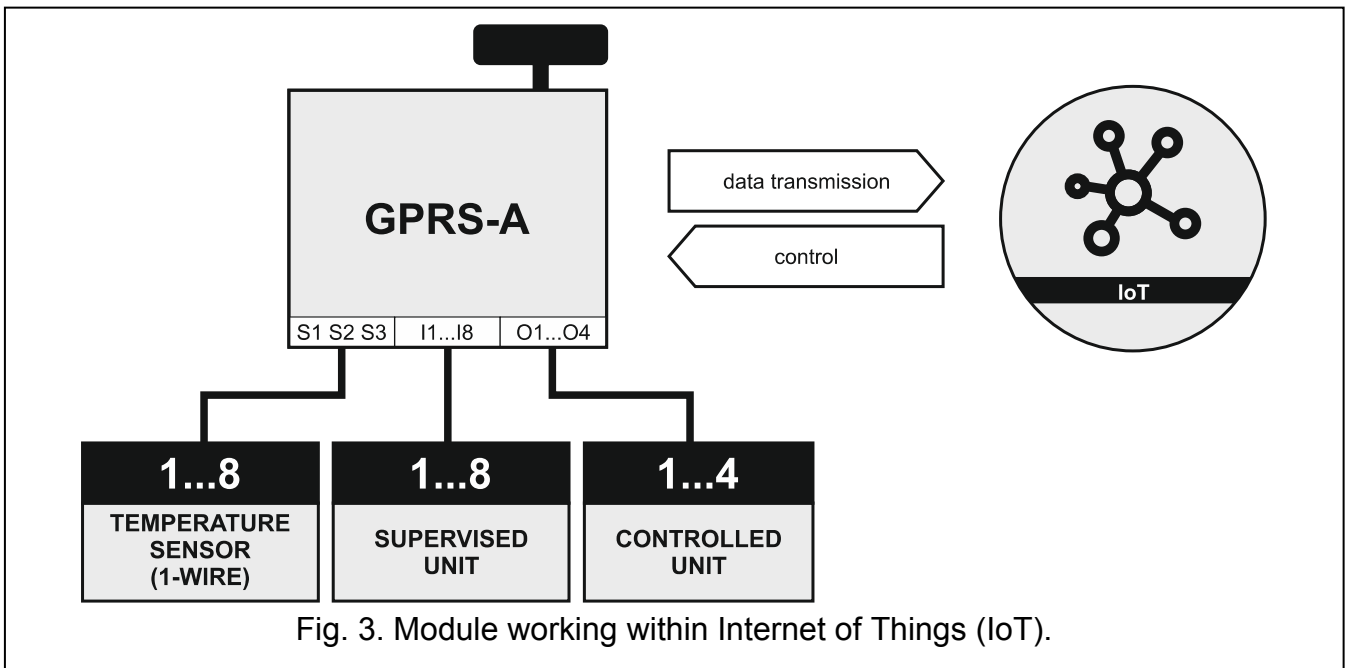

Using GPRS (TCP), the module can communicate with devices in the Internet of Things (IoT). This allows the module to be integrated e.g. with automation systems and measurement data acquisition systems. The module can send information about state of inputs / outputs as well as data from analog inputs and 1-Wire bus to the IoT devices. In response, the module can receive commands blocking / unblocking the inputs as well as activating / deactivating the outputs of the module.

4. Description of the module

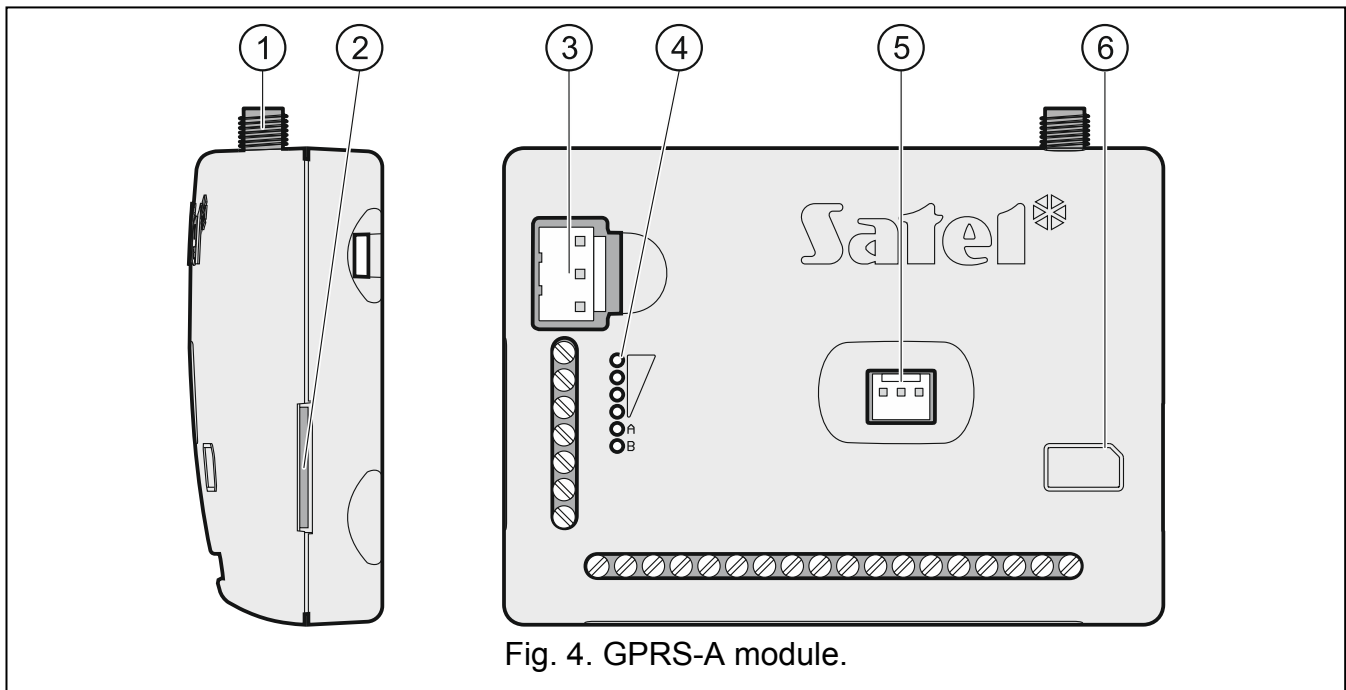

Fig. 4. GPRS-A module.

① antenna connector (the antenna is delivered with the module).

② SIM card slot.

i *Inserting the SIM card into its slot before programming the card PIN code in the module is not recommended (if the card requires entering the PIN code).*

③ APS connector for a SATEL power supply unit (e.g. APS-612).

④ LEDs indicating the module status (see “LED indicator”).

⑤ RS-232 (TTL) port.

⑥ information on how to install the SIM card.

Description of terminals

+12V – power input (12 V DC $\pm 15\%$).

COM – common ground.

RING, TIP – terminals for connecting the control panel telephone communicator.

S1...S3 – 1-Wire bus (1-Wire digital temperature sensors can be connected to the bus):

S1 – common ground,

S2 – data,

S3 – power supply.

I1...I8 – inputs. They can be programmed as digital (NC or NO type) or analog ones.

O1...O2 – OC type outputs (shorted to common ground when in active state).

O3...O4 – NO type relay outputs (normally open).

AC – input for supervision of AC voltage presence.

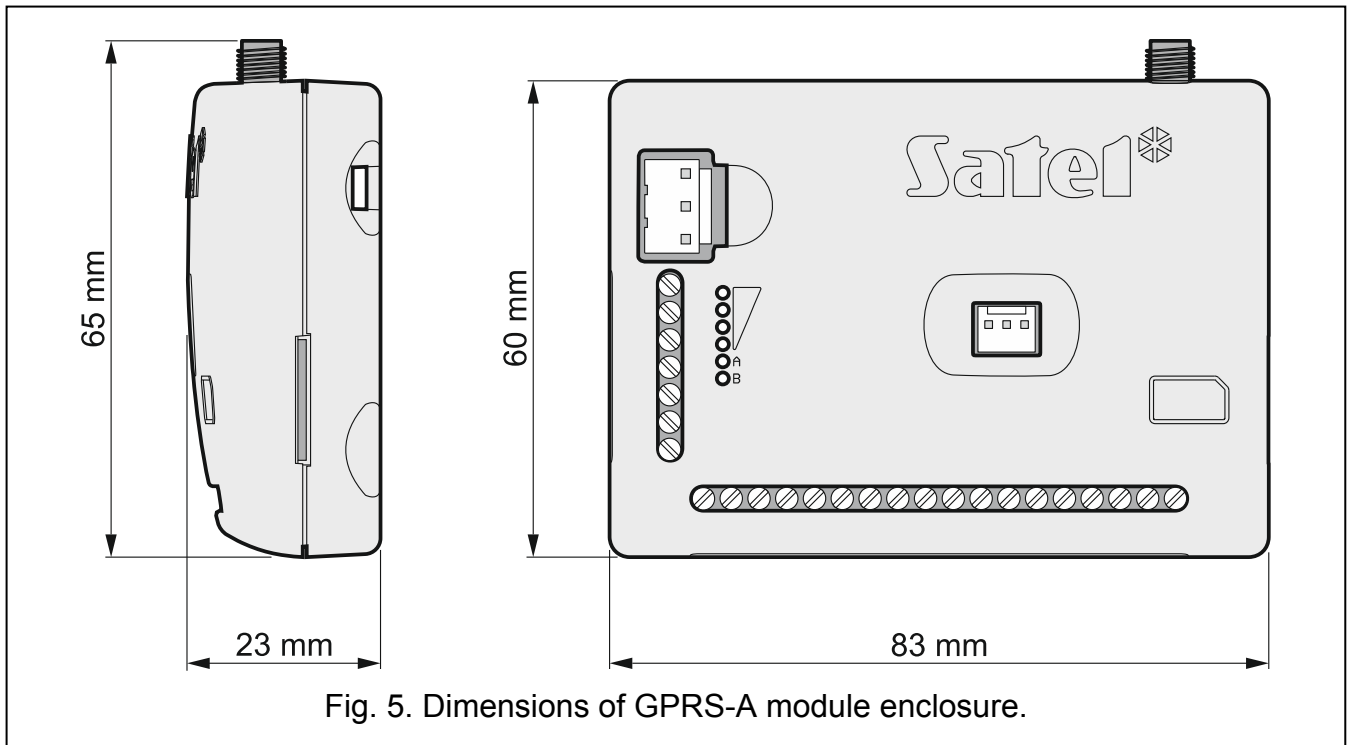

4.1 LED indicator

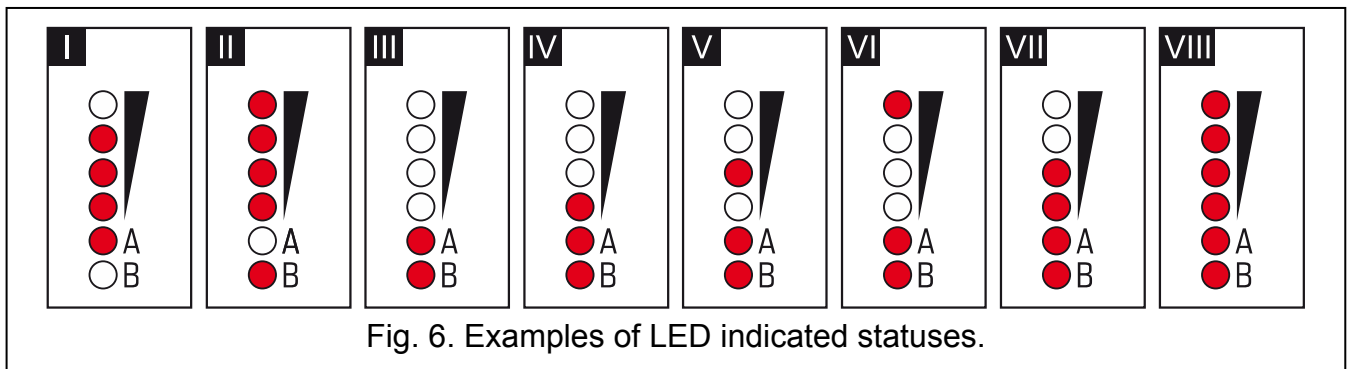

- I** (LED A is flashing, the other LEDs are ON) – GPRS transmission is going on; signal level: 3.
- II** (LED B is flashing, the other LEDs are ON) – SMS message is being sent, module is calling (CLIP); signal level: 4.
- III** (LEDs are flashing) – logging into GSM network.
- IV** (LEDs are flashing) – logging into GSM network has failed; missing SIM card.
- V** (LEDs are flashing) – logging into GSM network has failed; incorrect PIN code.
- VI** (LEDs are flashing) – logging into GSM network has failed; SIM card has been blocked after three attempts to use an invalid PIN code (PUK code must be used to unblock the SIM card).
- VII** (LEDs are flashing) – GSM phone is disabled (see “SIM” option p. 22).
- VIII** (LEDs are flashing) – module waiting for configuration settings to be loaded.

5. Installation



Disconnect power before making any electrical connections.

It is not advisable to power up the module if the antenna is not connected.

The installation to which the module is to be connected should be provided with:

- **2-pole disconnecter,**
- **short-circuit protection with a 16 A time delay circuit breaker.**

The GPRS-A module should be installed indoors, in spaces with normal air humidity. When selecting the mounting location, remember that thick masonry walls, metal partitions, etc. will reduce the range of radio signal. It is not advisable to install the module in close vicinity to electrical installations, because this can result in malfunctioning of the device.



If the module is to comply with requirements of the EN50131 standard for Grade 2, it must be installed in an additional enclosure that will enable it to meet requirements of the tamper standards (e.g. in the SATEL OPU-3 or OPU-4 enclosure).

5.1 Preparing the cabling

Run the cables to be used for connecting the module with other devices to the module installation place. Do not lay the cables in immediate vicinity of the low-voltage electrical network wires, especially those used for supplying the high-power equipment (such as electric motors).

It is recommended that unshielded non-twisted cable to be used.

5.2 Installation of the module

The module enclosure base makes it possible to secure the module to the mounting surface by using e.g. a cable tie or angle hooks.

5.3 Installation of antenna

The GPRS-A module is delivered with an antenna. The antenna can be replaced with another antenna mounted on the enclosure or at some distance from it.

Using the antenna mounted at some distance from the enclosure is recommended wherever thick masonry walls, metal partitions etc. may decrease the range of radio signal at the module installation place.

The antenna must not be installed in parallel to low-voltage electrical wires, or it can affect performance of the antenna.

5.4 Connecting the alarm control panel

Connect the control panel telephone communicator to the TIP and RING terminals.

5.5 Connecting the devices to the inputs and outputs

1. Connect the devices whose operation is to be monitored by the module to the input terminals.
2. If the module is to monitor the presence of AC voltage fed into the device from which the module is supplied, the wire from the secondary winding of transformer from which that device is supplied is to be connected to the AC input terminal (see Fig. 7).
3. Connect the devices which are to be controlled by the module to the terminals of outputs.

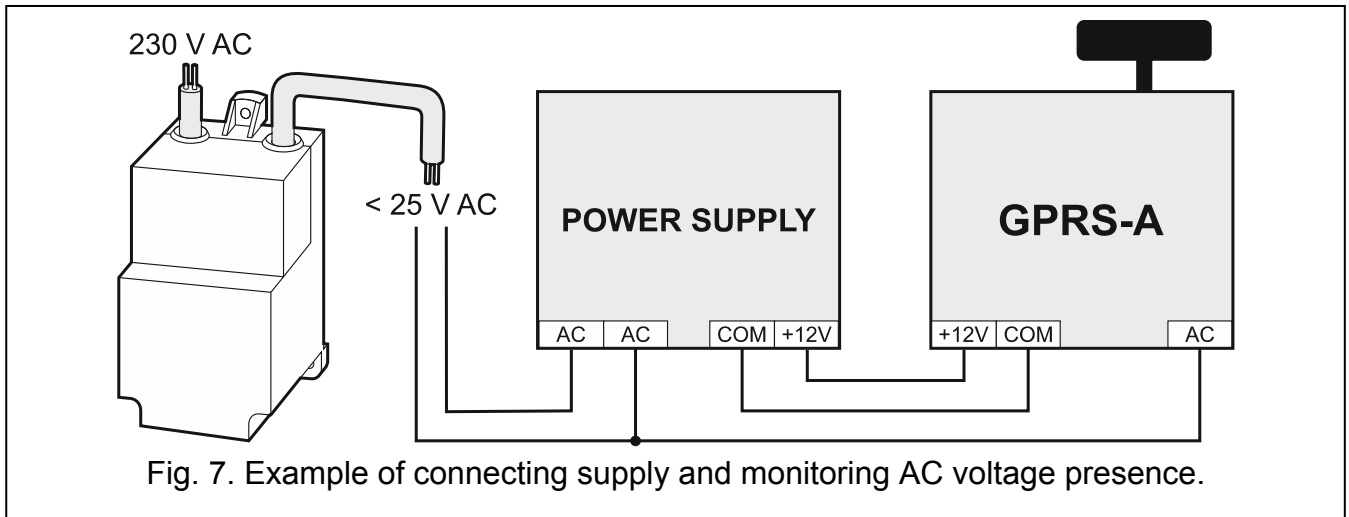

Fig. 7. Example of connecting supply and monitoring AC voltage presence.

5.6 Connecting the digital temperature sensors (1-Wire)

You can connect up to 8 digital temperature sensors to the 1-Wire bus. The length of wires should not exceed 30 meters. If several sensors are to be connected to the bus, it is recommended that you use the distribution box module (MZ-2 or MZ-3).

SATEL's product offering includes the **DS-T1** waterproof temperature sensors. They make it possible to measure temperatures ranging from -35°C to 60°C . They are designed for surface mounting indoors or outdoors. To secure them to the mounting surface, you may use adhesives or screws. The DS-T1 sensor wires are to be connected to the bus terminals in the following manner:

- black wire – terminal S1 (common ground),
- green wire – terminal S2 (data),
- white wire – terminal S3 (power).

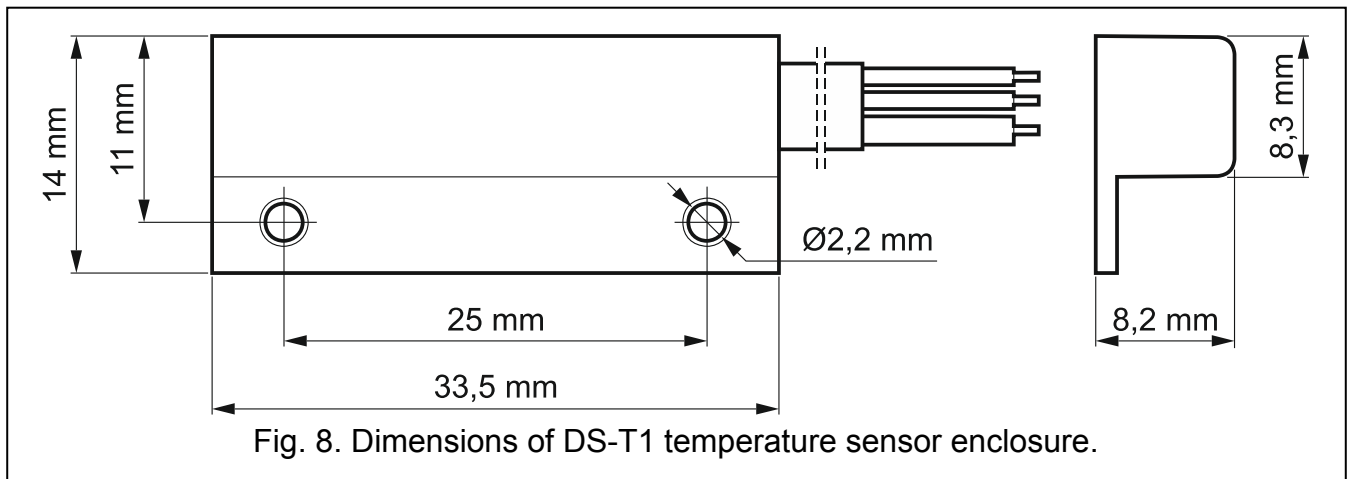

Fig. 8. Dimensions of DS-T1 temperature sensor enclosure.

5.7 Connecting the power supply and starting the module

The module may be powered from the control panel, from an expander with power supply, or from a power supply unit with current limitation up to 3 A. SATEL offers power supplies (e.g. APS-612), which can be connected to the APS connector on the electronics board.



The required output current of power supply is at least 250 mA.

1. Depending on the selected method of module powering, connect the power supply unit to the APS connector or connect the power leads to the +12V and COM terminals (use

flexible conductors with a cross-section of 0.5-0.75 mm², or rigid conductors with a cross-section of 1-2.5 mm²).



Never connect power supply to APS connector and terminals at the same time.

2. Power up the module. The module will start up.

5.8 Connecting the computer to the module

Connect the computer to the module RS-232 (TTL) port. To make the connection, use the USB-RS converter offered by SATEL. Having connected the computer to the module, you can:

- configure the module by using the GX Soft program. You can download the GX Soft program from the www.satel.eu website. It can be installed on computers with WINDOWS VISTA/7/8/10 operating system. For more information, please refer to section “Configuring” (p. 12).
- update the module firmware.

5.9 Installing the SIM card

1. If PIN code is required by the SIM card, use the GX Soft program to program the code (see p. 22).
2. Power down the module.
3. Insert the SIM card into its slot as shown on the enclosure.
4. Power up the module. Logging the telephone into the GSM network may take a few minutes.



If the module is to send data in GPRS technology, it is recommended that you use SIM cards with a dedicated tariff plan for M2M (machine-to-machine) communication.

If the programmed PIN code is invalid, the module will report a trouble. Programming a correct PIN code will clear the trouble.

Restarting the module with a wrongly programmed PIN code three times will block the SIM card. To unblock the SIM card, remove it and insert into a mobile phone. Then, enter the PUK code.

6. Configuring

You can configure all the module settings by using a computer with GX Soft program installed. Communication between the computer and the module can take place locally (via RS-232 (TTL) port) or remotely (via GPRS).

Module with factory settings can only be programmed locally. Remote programming is only possible after settings for communication via GSM/GPRS (see p. 22). Communication between the program and the module is encrypted.

Having programmed the SMS control commands in the module (see “SMS control” p. 39), you can configure some working parameters of the module by using SMS messages.

6.1 Description of the GX Soft program



In the WINDOWS VISTA or WINDOWS 7 system, provided the size of fonts and other screen elements is increased, the GX Soft program will be displayed correctly, if the “Use Windows XP style DPI scaling” option is disabled (the option is available when configuring the screen settings in the “Custom DPI Setting” window).

Access to the program can be password protected (see ““Configuration” window” p. 17).

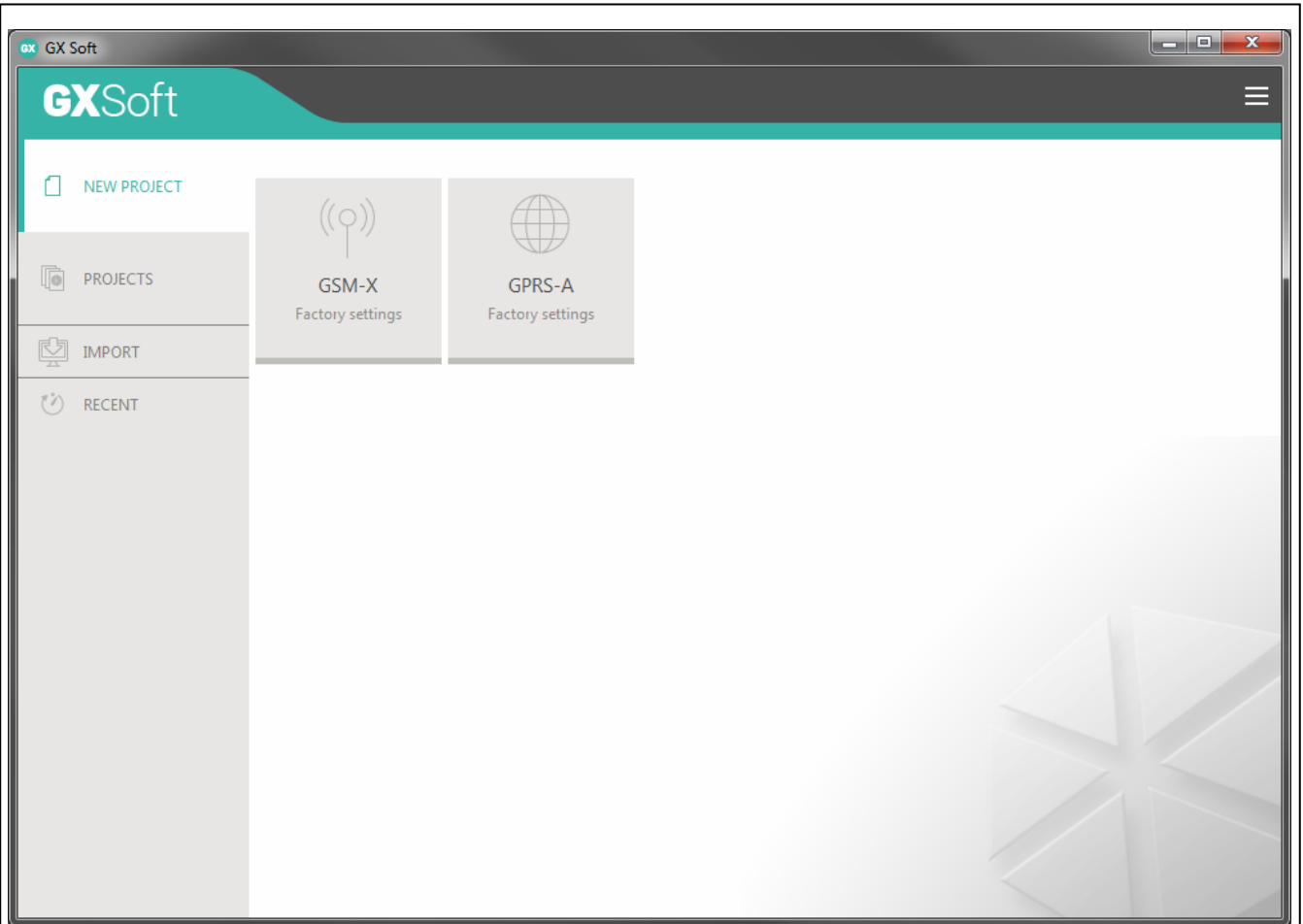

Fig. 9. GX Soft window when the program is run for the first time.

6.1.1 Menu bar in the GX Soft program

The menu bar is displayed in the top part of the program window. Appearance of the menu bar depends on the contents presented in the window.

Menu bar in the “Projects” tab

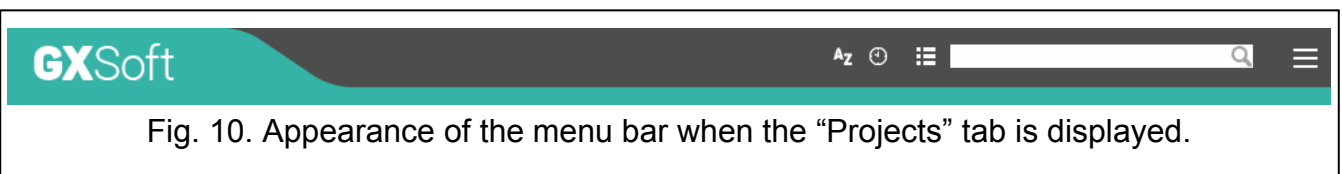

Fig. 10. Appearance of the menu bar when the “Projects” tab is displayed.

The search field is displayed on the menu bar. If you want to find a project file, click on the search field and start entering characters. The current view will be filtered out, based on the text entered.

Buttons

Az click, if the files are to be sorted by name (the arrow next to the button indicates whether the files from A to Z or from Z to A are displayed).

🕒 click, if the files are to be sorted by the time they were saved to disk (the arrow next to the button indicates whether the files are displayed in the descending or ascending order)

☰ click, if the information about files is to be presented in brief version.

-  click, if the information about files is to be presented in full version.

-  click to display additional menu.

Appearance of the menu bar when displaying the module data





- ① type of module and firmware version.
- ② information about the SIM card used, GSM signal level and operator of the GSM network used by the module.
- ③ date and time according to the module clock (Greenwich Mean Time (GMT)).
- ④ information on the way of communication with the module:
COM – local connection,
TCP – remote connection (GPRS).

Buttons

 click to display the list of troubles.

 click to establish connection to the module. The button is displayed when the program is not connected to the module.

 click to finish connection to the module. The button is displayed when the program is connected to the module.

 click to read data from the module.

 click to write data to the module.

 click to start test transmission to monitoring station.

 click to display information on the status of inputs and outputs. The button is active after connection to the module is established.

 click to display additional menu.

6.1.2 Side menu

The side menu is displayed on the left side of the program window. Appearance of the menu depends on the contents presented in the window.

The side menu before the module data are displayed

New project – click to display the “New project” tab.

Projects – click to display the “Projects” tab.

Import – click to import the file with module settings.

Recent – the list of recently opened files. Click on the name of the file to open it.

“New project” tab

The tab displays the files with default settings of the GSM-X and GPRS-A modules.

“Projects” tab

The tab displays the files saved to the computer disk, containing data of the GSM-X and GPRS-A modules.

The side menu after the module data are displayed

After the file with module data is opened or connection with the module is established, the side menu will display buttons which open the tabs used for configuration of the module settings.

6.1.3 Additional menu

The additional menu is displayed after you click on . Appearance of the menu depends on the contents presented in the window.

Open – click to display the “Projects” tab.

Save – click to save the module data to the computer disk.

Export – click to export the file with module data.

Connection – click to open the “Connection” window.

Configuration – click to open the “Configuration” window.

About – click to display information about the program.

Licence agreement – click to show the license agreement.

“Connection” window

In the window, you can choose how connection with the module is to be established:

- if the module is to be programmed locally from the computer connected to the RS-232 (TTL) port of the module, select “Local connection”,
- if the module is to be programmed remotely through SATEL server via GPRS, select “Remote connection: SATEL server”,
- if the module to be programmed remotely via GPRS, but the module is to connect directly to the program, select “Remote connection: Module >> GX Soft”.

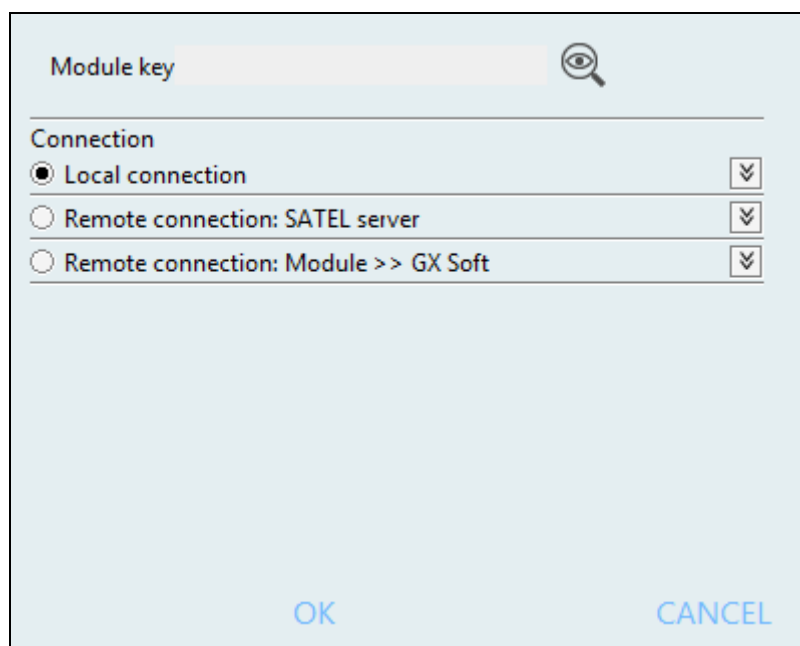



Fig. 12. “Connection” window: local connection settings.

Module key – a string of characters for identification of the module. It must be identical to that programmed in the module (see “Communication” p. 29). Click on  to see the key.

Local connection

GPRS-A module – COM port of the computer through which communication with the RS-232 (TTL) port of module is to take place.

Refresh – click to refresh the list of modules connected to the computer.

Remote connection: SATEL server

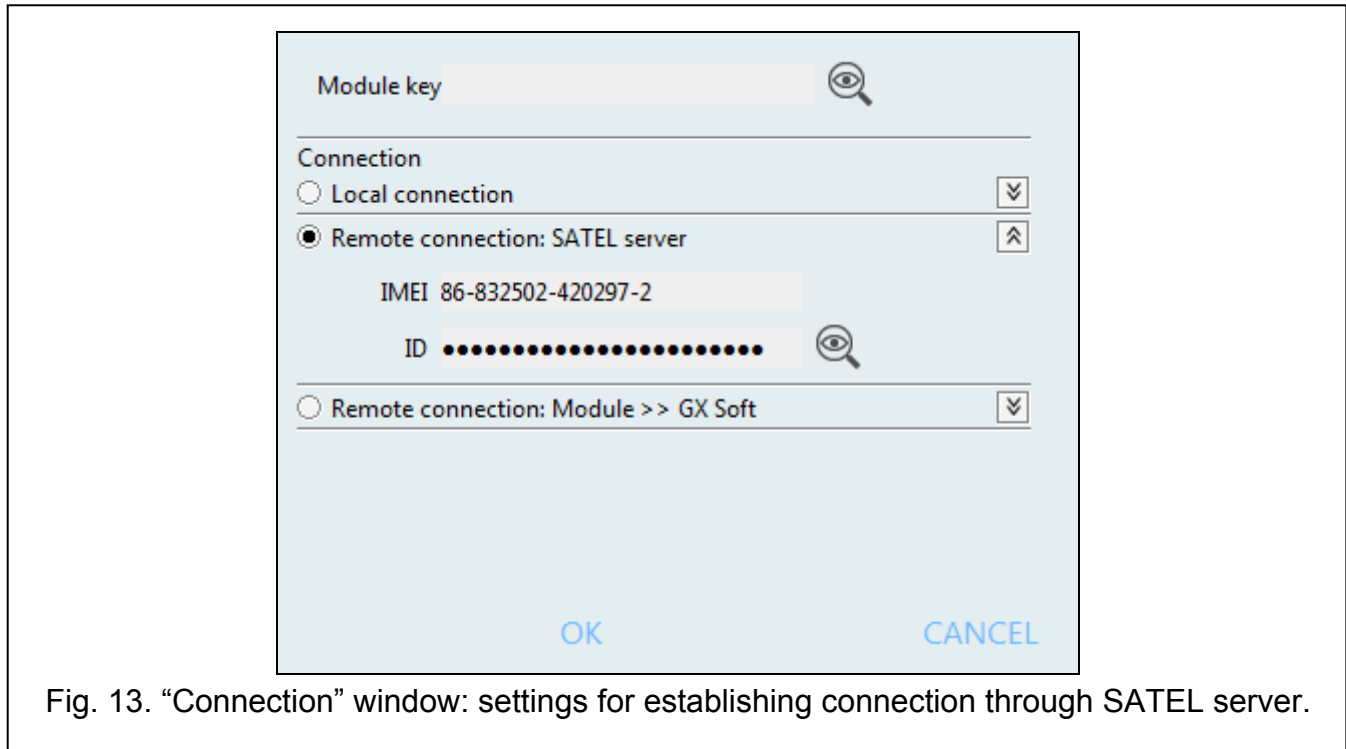



Fig. 13. “Connection” window: settings for establishing connection through SATEL server.

IMEI – individual identification number of the module GSM telephone.

ID – individual identification number for the purposes of communication through the SATEL server. The number is assigned automatically by the SATEL server during the first connection to the server (before the number is assigned, “F” characters are displayed). Click on  to see the ID.

Remote connection: Module>>GX Soft

TCP/IP port – number of the port on which the computer with GX Soft program is awaiting the incoming connections from the module.

Buttons

OK – click to confirm the changes.

Cancel – click to close window without saving changes.

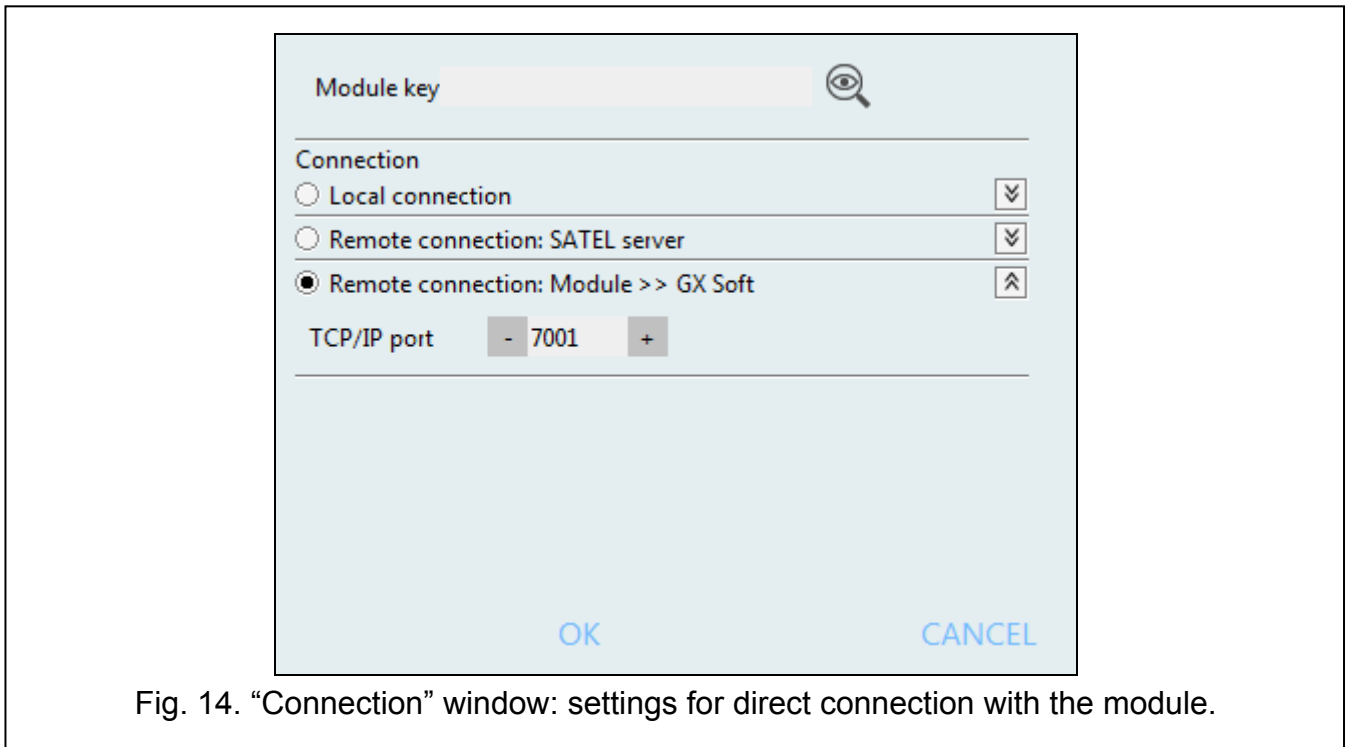

Fig. 14. “Connection” window: settings for direct connection with the module.

“Configuration” window

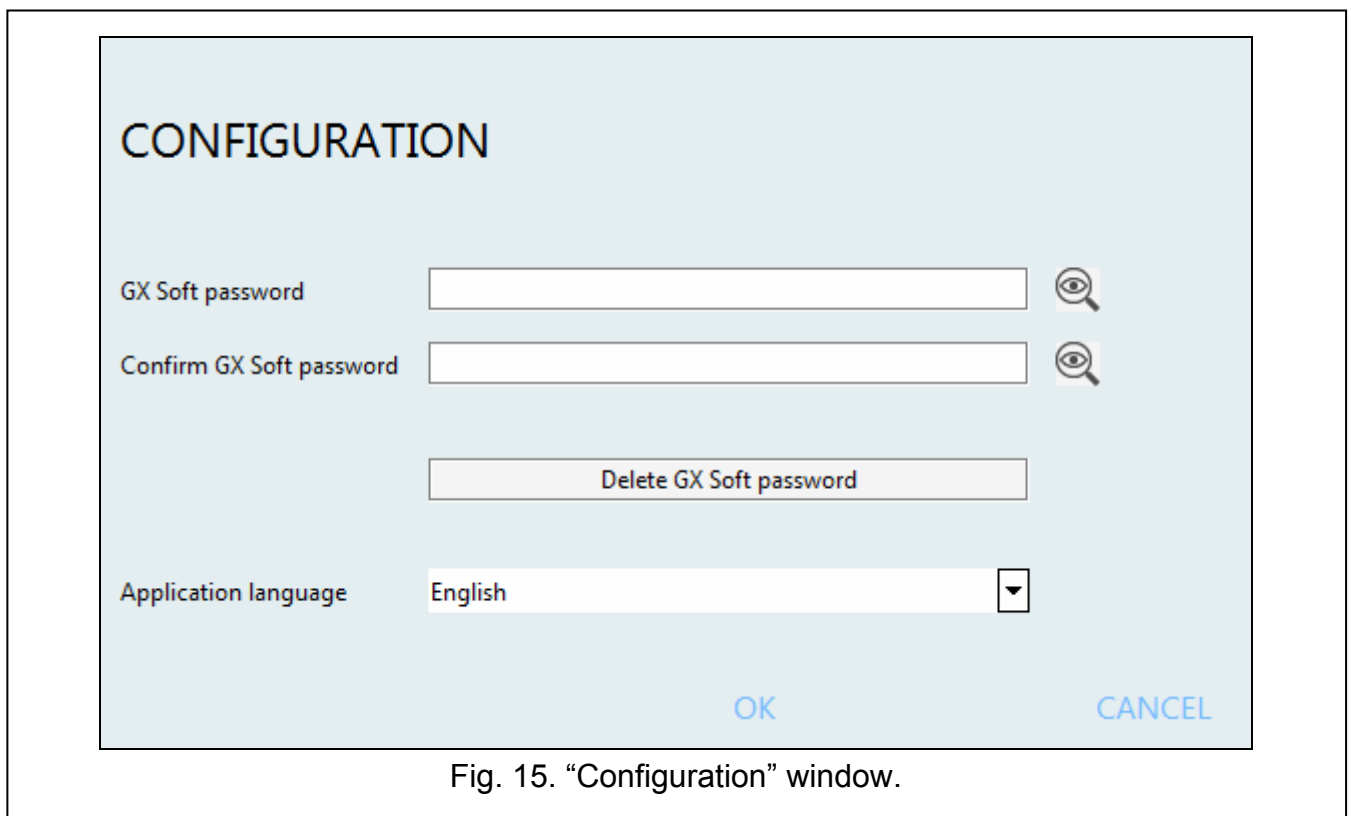

Fig. 15. “Configuration” window.

GX Soft password – if you want to protect the program against unauthorized access, you can enter the password. Click on to see the password.

Confirm GX Soft password – enter the password to confirm it is correct. Click on to see the password.

Application language – you can select a program language.

Buttons

Delete GX Soft password – click to delete the password.

Save – click to save changes.

Cancel – click to close window without saving changes.

6.2 Establishing connection between the program and the module



Establishing connection is possible, if an identical “Module key” has been programmed in the module and in the program, except for the module with factory settings.

6.2.1 Local connection

1. Connect the module RS-232 (TTL) port with the computer port using the USB-RS converter offered by SATEL.
2. Open the file with module data (the file with default settings (“New project” tab) or the file saved on the computer disk (“Projects” tab)).
3. Configure the settings required to establish local connection (see ““Connection” window” p. 15).
4. Click  on the menu bar.
5. A window will open with information that connection has been established and a prompt to read the data.
6. Click “Yes” if you want to read the data stored in the module.

6.2.2 Remote connection: SATEL server



The “Connect to GX Soft” option must be enabled in the module (see “Communication” p. 29). By default, this option is disabled.

1. Open the file with module data (the file with default settings (“New project” tab) or the file saved on the computer disk (“Projects” tab)).
2. Configure the settings required to establish connection through the SATEL server (see ““Connection” window” p. 15).
3. Click  on the menu bar.
4. A window will open with information that connection has been established and a prompt to read the data.
5. Click “Yes” if you want to read the data stored in the module.

6.2.3 Remote connection: Module>>GX Soft



The computer running the GX Soft program must have a public IP address.

A control command, after receiving of which the module will make an attempt to establish connection, must be programmed in the module (see “Direct connection to GX Soft” p. 30).

1. Open the file with module data (the file with default settings (“New project” tab) or the file saved on the computer disk (“Projects” tab)).
2. Configure the settings required to establish direct connection (see ““Connection” window” p. 15).
3. Click  on the menu bar.

4. Send an SMS message with the following content to the number of SIM card currently used by the module:
 - xxxx** (“xxxx” – control command that initiates establishing connection with the GX Soft program) – the module is to connect to the computer whose address has been programmed in the module,
 - xxxx=aaaa:p=** (“xxxx” – control command that initiates establishing connection with the GX Soft program; “aaaa” – address of the computer running the GX Soft program; “p” – TCP port) – the module is to connect to the computer whose address has been given in the SMS message and use for communication the TCP port given in the SMS message. The “Server address from SMS” option must be enabled in the module (p. 30).
5. After the module connects to the computer, a window will open with information that connection has been established and a prompt to read the data.
6. Click “Yes” if you want to read the data stored in the module.

6.3 Project

The tab allows entering data for easier identification of the project created.

Fig. 16. “Project” tab.

Project name – individual name of the project.

Owner – name of the project owner.

Address – project owner address data.

Contact telephone – project owner contact telephone number.

Module telephone number (SIM) – telephone number of SIM card installed in the module.

Notes – additional information / notes stored in the project.

Module – type and version of the module firmware.

IMEI – individual identification number of the module GSM communicator.

ID – individual identification number of the module for the purposes of communication through the SATEL server (assigned automatically by the SATEL server).

 – click the button to open the window in which the QR code is displayed. The QR code contains information required when configuring settings of communication through the SATEL server. You can read the QR code by using a mobile device or export to PNG file and transmit to the users. The QR code facilitates configuring the GX Control application settings.

6.4 Data

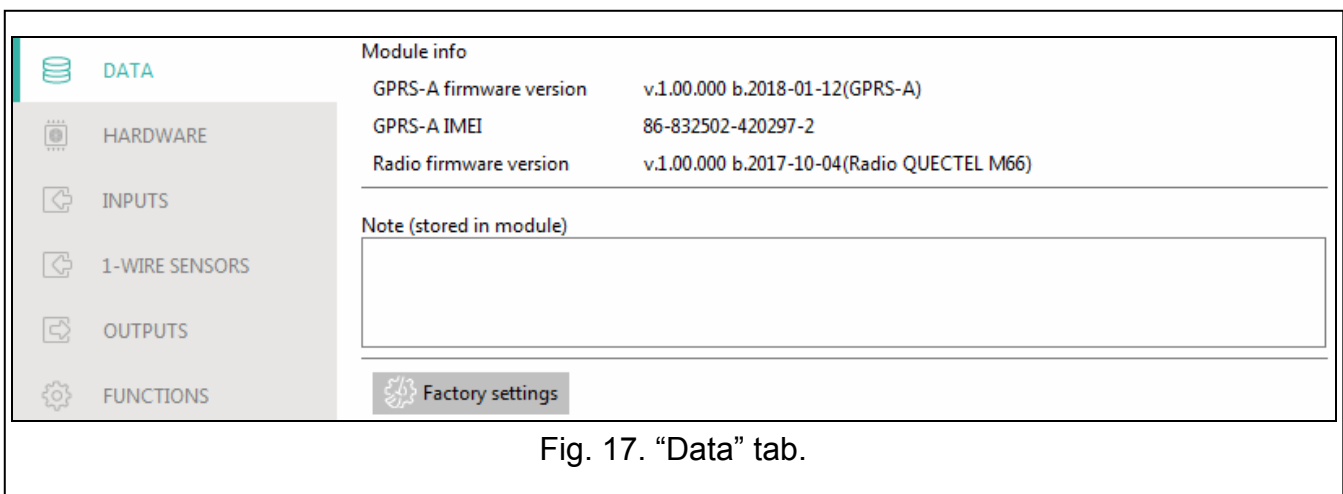

Fig. 17. “Data” tab.

Module info

GPRS-A firmware version – version number of module firmware.

GPRS-A IMEI – individual identification number of the module GSM communicator.

Radio firmware version – version number of radio firmware.

Note (stored in module) – additional information / notes stored in module memory.

Factory settings – click to restore module factory settings. A message box will be displayed in which you must confirm your intention to restore the factory settings of the module.

6.5 Hardware

6.5.1 Mainboard

Module language – you can select the language in which the module will communicate with the GX Soft program and GX Control application. Default names of inputs, 1-Wire sensors, outputs, users and descriptions of events will be displayed in the language selected, regardless of the language version of the program (see ““Configuration” window” p. 17) and application.

Tel. numbers verification (SMS control and answer to CLIP)

Users tel. numbers – if this option is enabled, SMS control is possible from user telephones only (see “Users” p. 45). The module can also answer to CLIP from a user telephone.

No verification – if this option is enabled, the module can be controlled from any telephone. The module can also answer to CLIP from any telephone.

Fig. 18. “Mainboard” tab.

Time synchronization



The module uses the Greenwich Mean Time (GMT), not the local time (the time zones are not taken into account).

NTP – if this option is enabled, the module clock is synchronized with the time server.

GSM – if this option is enabled, the module clock is synchronized with the time of GSM network operator.

NTP server – time server address. The field is available if the “NTP” option is enabled. You can enter the IP address or domain name.

Answer to CLIP

The module offers the CLIP answering feature. CLIP means calling without establishing connection (you must hang up on hearing the ring signal), i.e. toll-free. The module will identify the phone number of the calling party and respond accordingly.

NONE – select this option if the module is not to answer to CLIP.

SMS – select this option if the module is to answer to CLIP using SMS message.

CLIP – select this option if the module is to answer to CLIP using CLIP.

Send SMS with module state on CLIP – if the option is enabled, in response to CLIP the module will send an SMS message with the module status information (see p. 49).

Send SMS with 1-Wire sensors state on CLIP – if the option is enabled, the module will send an SMS message with information about the temperature recorded by the 1-Wire sensors in reply to CLIP (see p. 49).



If the “Send SMS with module state on CLIP” and “Send SMS with 1-Wire sensors state on CLIP” options are enabled, in response to CLIP the module will send an SMS with “GPRS-A CLIP” content.

CLIP starts test transmission – if the option is enabled, CLIP will start a test transmission.

Test transmissions

On time (GMT) – select this option if the test transmission is to be sent every day at a specified time. Define the hour and minute.

Every – select this option if the test transmission is to be sent at specified time intervals. Define every how many days, hours and minutes.



The module will send a test transmission if, when configuring the module events distribution, you define the monitoring station to which a test transmission is to be sent (see “Module events distribution” p. 35).

The test transmission is sent using all transmission paths included in the list that defines the order of using transmission paths (see “Reporting priority” p. 35).

6.5.2 GSM

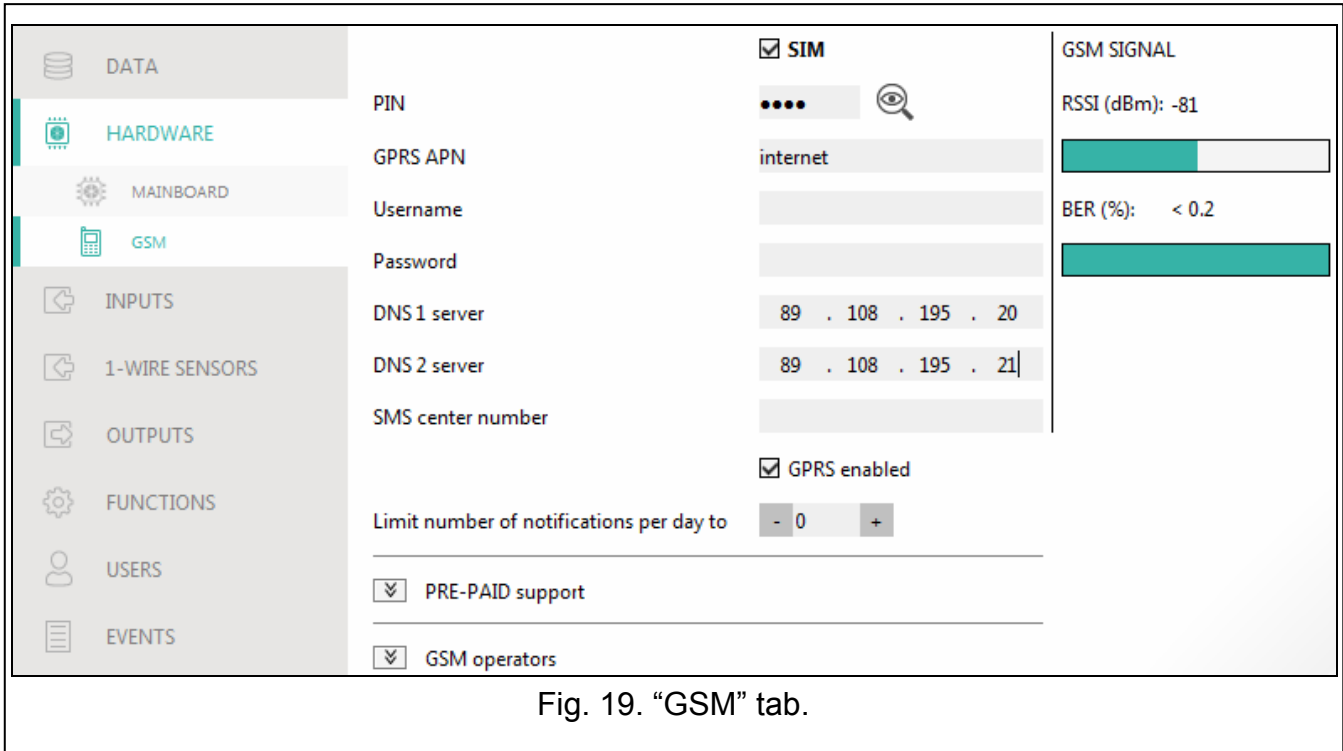

Fig. 19. “GSM” tab.

SIM – if this option is enabled, the SIM card is supported by the module. Disable the option, if the card is not to be used. Disabling the option will prevent unnecessary reporting of troubles related to that card.

PIN – PIN code of the SIM card. Click on to see the code.



If an incorrectly programmed PIN code is used, the module will report a trouble and will be waiting until the correct PIN code is entered.

Restarting the module with a wrongly programmed PIN code three times will block the SIM card. To unblock the SIM card, remove it and insert into a mobile phone. Then, enter the PUK code.

GPRS APN – access point name for Internet GPRS connection.

Username – user name for Internet GPRS connection.

Password – password for Internet GPRS connection.

DNS 1 server / DNS 2 server – IP address of DNS server to be used by the module. It is recommended to program the IP address of DNS server. The IP address is necessary for sending data using GPRS technology, if the address of the device the module is to connect to (monitoring station, computer with GX Soft program) is entered as a name.



The GPRS parameters can be obtained from the GSM network operator.

SMS center number – telephone number of the short message service center. It is used as a connecting link when sending SMS messages. If the number has been saved by the operator to the SIM card memory, it need not be programmed. Otherwise, if the module is to send SMS messages, it must be entered. The number must be suitable for the operator of network in which the SIM card is registered.

GPRS enabled – enable this option if the data are to be sent using GPRS technology. If the option is disabled, sending data via GPRS is not available.

Limit number of notifications per day to – this field allows you to specify the maximum number of transmissions (GPRS, SMS, CLIP) made by the module during a day. Values from 0 to 255 can be entered. Entering 0 means no transmission limit (default: 0).

PRE-PAID support

Check balance USSD code – the USSD code which is used to check balance of the SIM card account. If the code has been programmed, the module can check the SIM card account balance.

Minimum balance level – the minimum amount of funds on the SIM card account. If the amount of funds drops below the minimum level:

- trouble will be reported,
- where the SIM card account balance is checked automatically, information on the account balance will be sent as an SMS message to the phones of users for which the “Forward SMS” option is enabled (see “Users” p. 45).

Check balance every – the field defines every how many hours the module will perform the SIM card balance check. Entering 00:00 will disable the check.

GSM operators

MCC/MNC code – codes of the operator of GSM network to which the SIM card is to log in. Enter in turn:

- MCC (Mobile Country Code) – country code,
- MNC (Mobile Network Code) – operator code.

Remember that entering invalid data may make logging into the GSM network impossible. Unless you enter the code, the module will log into the SIM card operator network (“auto” option disabled) or into the network offering the best signal (“auto” option enabled).

auto – if this option is enabled and the module cannot log into the network of GSM operator defined by means of the MCC/MNC code, it will log into the available GSM network.

Get GSM operators list – click on the button if you want to download the list of GSM network operators. When the list appears, select one of the available GSM network operators. The operator's codes will be entered automatically.

GSM SIGNAL





RSSI (dBm) – indicator of received radio signal strength.

BER (%) – bit error rate in digital transmission (the ratio of the number of errored bits to the total number of bits transmitted).

6.6 Inputs

6.6.1 State

The numbers above the buttons correspond to the numbers of inputs.

-  input not used. The “OFF” option is selected in the “Type” field (see: “Type” p. 24).
-  input in normal state (not violated / threshold not exceeded). Click to block the input.
-  input violated / threshold exceeded. Click to block the input.
-  input blocked. Click to unblock the input.

If the input has been programmed as analog one, the value of input voltage or the value of physical quantity recorded by the sensor connected to the input (e.g. air humidity) is

displayed under the button. The physical quantity is displayed when the voltage scaling to the valued recorded by the sensor has been programmed for the input (see “Scaling” p. 26).

The screenshot shows the 'Inputs' configuration page. At the top, the 'STATE' section displays indicators for inputs 1 through 8 and AC, all of which are active (green checkmarks). Below this is the 'SETTINGS' table:

Input name	Type	L Threshold	H Threshold	Tolerance	Sensitivity	Restore	Block after	Counting period	Block duration
I1 Input 1	OFF								
I2 Input 2	OFF								
I3 Input 3	OFF								
I4 Input 4	OFF								
I5 Input 5	OFF								
I6 Input 6	OFF								
I7 Input 7	OFF								
I8 Input 8	OFF								
AC AC	OFF				00 m 01 s				

Below the settings table is the 'SCALING' section with a checked checkbox. The 'BLOCKING' section contains a table for blocking inputs:

Input name	BLOCKED							
	I1	I2	I3	I4	I5	I6	I7	I8
I1 Input 1	<input type="checkbox"/>	<input type="checkbox"/>	<input type="checkbox"/>	<input type="checkbox"/>	<input type="checkbox"/>	<input type="checkbox"/>	<input type="checkbox"/>	<input type="checkbox"/>
I2 Input 2	<input type="checkbox"/>	<input type="checkbox"/>	<input type="checkbox"/>	<input type="checkbox"/>	<input type="checkbox"/>	<input type="checkbox"/>	<input type="checkbox"/>	<input type="checkbox"/>
I3 Input 3	<input type="checkbox"/>	<input type="checkbox"/>	<input type="checkbox"/>	<input type="checkbox"/>	<input type="checkbox"/>	<input type="checkbox"/>	<input type="checkbox"/>	<input type="checkbox"/>
I4 Input 4	<input type="checkbox"/>	<input type="checkbox"/>	<input type="checkbox"/>	<input type="checkbox"/>	<input type="checkbox"/>	<input type="checkbox"/>	<input type="checkbox"/>	<input type="checkbox"/>
I5 Input 5	<input type="checkbox"/>	<input type="checkbox"/>	<input type="checkbox"/>	<input type="checkbox"/>	<input type="checkbox"/>	<input type="checkbox"/>	<input type="checkbox"/>	<input type="checkbox"/>
I6 Input 6	<input type="checkbox"/>	<input type="checkbox"/>	<input type="checkbox"/>	<input type="checkbox"/>	<input type="checkbox"/>	<input type="checkbox"/>	<input type="checkbox"/>	<input type="checkbox"/>
I7 Input 7	<input type="checkbox"/>	<input type="checkbox"/>	<input type="checkbox"/>	<input type="checkbox"/>	<input type="checkbox"/>	<input type="checkbox"/>	<input type="checkbox"/>	<input type="checkbox"/>
I8 Input 8	<input type="checkbox"/>	<input type="checkbox"/>	<input type="checkbox"/>	<input type="checkbox"/>	<input type="checkbox"/>	<input type="checkbox"/>	<input type="checkbox"/>	<input type="checkbox"/>

Figure 20. "Inputs" tab.

6.6.2 Settings

Input name – individual name of the input (up to 16 characters).

Type – you can program the input as:

OFF – not used.

ON – used to supervise power supply (type only available for AC input).

NC – digital, normally closed.

NO – digital, normally open.

Analog – voltage measurement from 0 to 16.56 V. Fig. 21 shows how the analog input works.

L Threshold – the lower threshold for analog input. Drop of the input value below the threshold (minus tolerance) means the threshold is exceeded (i.e. input is violated). If you enter no value, the threshold will not be monitored.

H Threshold – the upper threshold for analog input. Rise of the input value above the threshold means the threshold is exceeded (i.e. input is violated). If you enter no value, the threshold will not be monitored.

Tolerance – value by which response of the analog input is delayed. The module will register the **threshold exceeding** if the input value drops below the L threshold minus tolerance or rises above the H threshold plus tolerance. The module will register the **input restore** if the input value rises above the L threshold plus tolerance or drops below the H threshold minus tolerance.

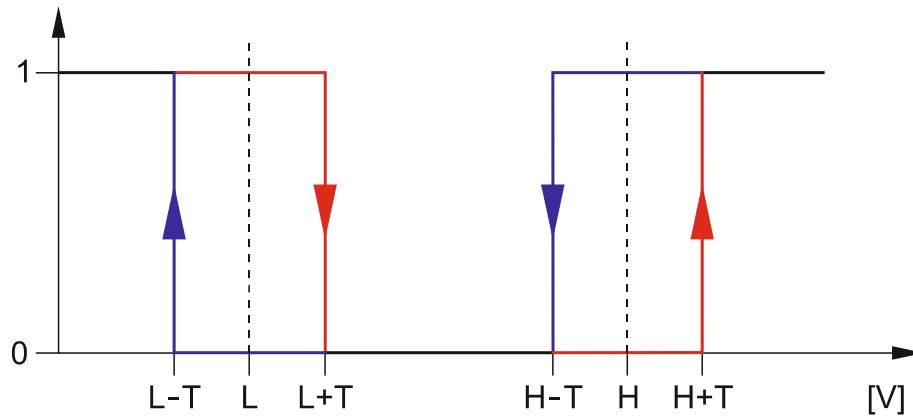

Fig. 21. Operation manner of analog input. 0 – normal state (no violation), 1 – threshold exceeded (violation), L-T - lower threshold minus tolerance, L – lower threshold, L+T – lower threshold plus tolerance, H-T – upper threshold minus tolerance, H – upper threshold, H+T – upper threshold plus tolerance.



Values in the “L Threshold”, “H Threshold” and “Tolerance” fields may go beyond the range of 0...16.56, if the voltage value on the analog input is scaled to the physical quantity recorded by the sensor (see “Scaling” p. 26). If this is the case, units other than volts (V) may be used.

Sensitivity – time during which:

- the NC type digital input must be disconnected from the ground so that the module can register the input violation,
- the NO type digital input must be shorted to ground so that the module can register the input violation,
- the analog input value must remain below the L threshold (minus tolerance) or above the H threshold (plus tolerance) so that the module can register a threshold exceeding (violation) (see Fig. 21).

You can program from 20 to 9980 ms (every 20 ms).

Restore – time during which:

- the NC type digital input must be again shorted to ground so that the module can register input restore,
- the NO type digital input must be again disconnected from the ground so that the module can register input restore,
- the analog input value must remain above the L threshold (plus tolerance) or below the H threshold (minus tolerance) so that the module can register input restore (end of violation).

The defined time makes it possible to reduce the number of sent transmissions. You can program from 4 to 255 seconds.

Block after – the number of violations / threshold exceedings after which the input will be automatically blocked (the input is blocked after restore). You can program from 0 to 15. Value 0 means no blocking.

Counting period – the time after which the counter of violations / exceedings programmed for the given input will be reset. You can program from 0 to 24 hours. Value 0 means that the violations will be counted without time limits.

Block duration – if the input is to be automatically blocked for a specific time period, it must be entered. You can program from 0 to 24 hours. Value 0 means that the given input will be blocked until unblocked by the user.

6.6.3 Scaling

You can define how the voltage value on analog input will be scaled to the physical quantity that is recorded by the sensor connected to the input. Use the linear characteristic from the sensor installation manual. This characteristic illustrates dependence between the sensor output voltage and the physical quantity recorded by the sensor (see Fig. 22).

Input name – individual name of the input.

Sensor characteristic – enter the voltage value and the corresponding value of the physical quantity for two points on the linear characteristic of the sensor (see the example in Fig. 22, where P1: 0.75 V -> 0% Rh and P2: 1.5 V -> 40% Rh).

Unit – unit of the physical quantity recorded by the sensor connected to the input.

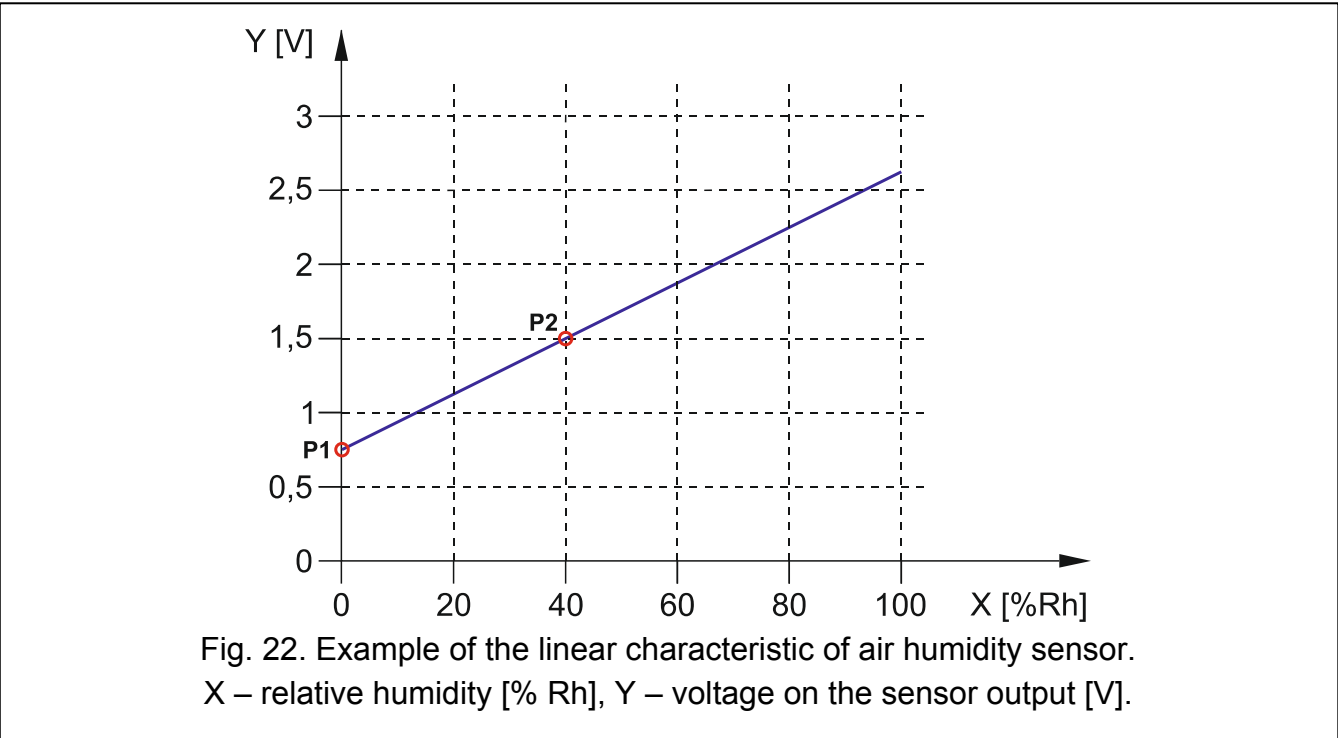

6.6.4 Blocking

You can indicate the input which, in the event of violation / threshold exceeding, will block other inputs of the module. The input restore means end of blocking. Each of the module inputs can block the other 7 inputs. The table lines present the blocking inputs, and the columns present the blocked inputs. If you want the input violation / threshold exceeding to block another module input, select the field at the intersection of the corresponding line and column.



6.7 1-Wire sensors

The 1-Wire bus can handle up to 8 digital temperature sensors. The way the 1-Wire sensors are being handled by the module is much the same as in the case of sensors connected to the analog inputs (see Fig. 21).

6.7.1 State

The numbers above the buttons correspond to the numbers of sensors.

- sensor not used (not identified – see: “Identify sensors” p. 28).
- normal state. Click to block the sensor.

-  L or H threshold exceeded. Click to block the sensor.
-  sensor blocked. Click to unblock the sensor.

Temperature recorded by the given sensor is displayed under the button (plus / minus correction value – see “Correction”).

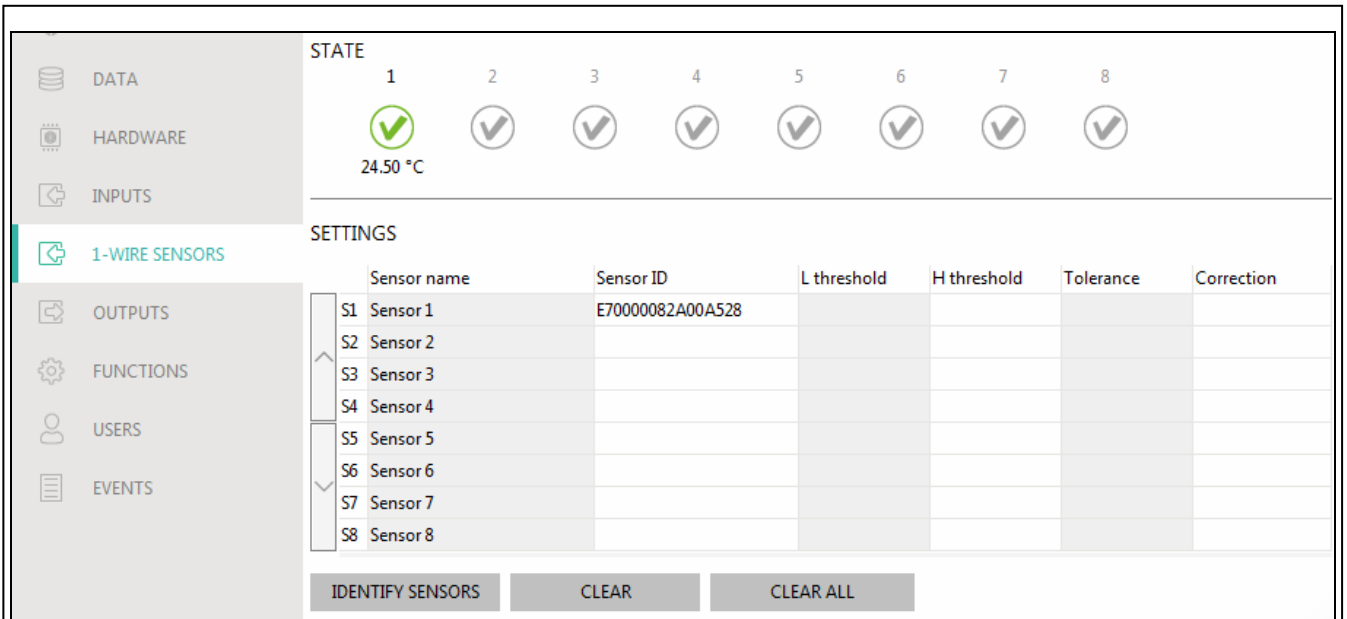

Fig. 23. “1-Wire sensors” tab.

6.7.2 Settings

Sensor name – individual name of the sensor connected to the bus (up to 16 characters).

Sensor ID – individual identification number of the sensor. The number is stored in the sensor memory. It will be read by the module after starting the sensor identification function.

L threshold – the lower temperature threshold for the sensor. If the temperature drops below the defined value (minus tolerance), the module will register a threshold exceeding. You can program temperatures ranging from -55°C to 125°C. If no value is defined, the temperature threshold will not be monitored.

H threshold – the upper temperature threshold for the sensor. If the temperature rises above the defined value (plus tolerance), the module will register a threshold exceeding. You can program temperatures ranging from -55°C to 125°C. If no value is defined, the temperature threshold will not be monitored.

Tolerance – value by which response of the module is delayed. The module will register the **threshold exceeding** if the temperature drops below the L threshold minus tolerance or rises above the H threshold plus tolerance. The module will register the **restore to normal state** if the temperature rises above the L threshold plus tolerance or drops below the H threshold minus tolerance.

Correction – the value by which the sensor recorded temperature is corrected by the module. You can program any value from -55°C to 125°C. The positive value is added to and the negative one is subtracted from the recorded temperature.

Buttons



– click to change position of the sensor on the list.

Identify sensors – click to run the identification function for sensors connected to the bus. During execution of the function, the module will read the ID numbers of connected sensors. The sensor ID number will be displayed in the “Sensor ID” field.

i *If sensors which have no designation are to be connected to the bus, connect them one at a time and run the identification function. Thus, you will be able to describe them accordingly yourself.*

The sensor will only be supported by the module after running the identification function.

Clear – click to delete selected sensor.

Clear all – click to delete all sensors.

6.8 Outputs

6.8.1 Control

The numbers correspond to the numbers of outputs.

1 OFF output inactive. Click to activate the output.

ON 1 output active. Click to deactivate the output.

CONTROL

1 OFF 2 OFF 3 OFF 4 OFF

SETTINGS

Output name	Operating time	1	2	3	4	Options
O1 Output 1	00 h 00 m 00 s	<input type="checkbox"/>	<input type="checkbox"/>	<input type="checkbox"/>	<input type="checkbox"/>	1 - Pulsed
O2 Output 2	00 h 00 m 00 s	<input type="checkbox"/>	<input type="checkbox"/>	<input type="checkbox"/>	<input type="checkbox"/>	2 - Problem with transmission to station 1
O3 Output 3	00 h 00 m 00 s	<input type="checkbox"/>	<input type="checkbox"/>	<input type="checkbox"/>	<input type="checkbox"/>	3 - Problem with transmission to station 2
O4 Output 4	00 h 00 m 00 s	<input type="checkbox"/>	<input type="checkbox"/>	<input type="checkbox"/>	<input checked="" type="checkbox"/>	4 - GSM trouble

TRIGGERING

Input name	Type	L Threshold	H Threshold	Tolerance	O1 L	O1 H	O2 L	O2 H	O3 L	O3 H	O4 L	O4 H
I1 Input 1	OFF											
I2 Input 2	OFF											
I3 Input 3	OFF											
I4 Input 4	OFF											
I5 Input 5	OFF											
I6 Input 6	OFF											
I7 Input 7	OFF											
I8 Input 8	OFF											
AC AC	OFF				-	-	-	-	-	-	-	-
S1 Sensor 1	1-Wire				-	-	-	-	-	-	-	-
S2 Sensor 2	1-Wire				-	-	-	-	-	-	-	-
S3 Sensor 3	1-Wire				-	-	-	-	-	-	-	-
S4 Sensor 4	1-Wire				-	-	-	-	-	-	-	-
S5 Sensor 5	1-Wire				-	-	-	-	-	-	-	-
S6 Sensor 6	1-Wire				-	-	-	-	-	-	-	-
S7 Sensor 7	1-Wire				-	-	-	-	-	-	-	-
S8 Sensor 8	1-Wire				-	-	-	-	-	-	-	-

Fig. 24. “Outputs” tab.

6.8.2 Settings

Output name – individual name of the output (up to 16 characters).

Operating time – time during which the output is active. Entering “0” will keep the output in the same state until deactivated by the user.

Options

Pulsed – if this option is enabled, the output is pulsating when it is active. The option does not apply to relay outputs.

Problem with transmission to station 1 / 2 – if this option is enabled, the output will be active in the case of any problem with transmitting events to the monitoring station 1 / 2.

GSM trouble – if this option is enabled, the output is active in case of a problem with logging into the GSM network. The output will turn on about 2 minutes after a problem with logging into GSM network occurs, which may be caused by:

- missing SIM card,
- entering a wrong PIN code,
- missing or damaged antenna,
- unavailable GSM network (out of range),
- telephone damage.

6.8.3 Triggering

You can define whether and how the inputs / 1-Wire sensors are to control the outputs. The table lines present the inputs / 1-Wire sensors, and the columns O1 L/H...O4 L/H present the outputs of the module. If you want the input violation / threshold exceeding to change the output state, select one of the available options in the selection field at the intersection of the corresponding line and column:

- - input / sensor does not control the output.

1: ON – violation of the input / threshold exceeding will activate the output.

2: OFF – violation of the input / threshold exceeding will deactivate the output.

3: ON FOR TIME – violation of the input / threshold exceeding will activate the output for the time programmed in the “Operating time” field (see p. 29).

4: TOGGLE – violation of the input / threshold exceeding will switch the output to its opposite state.

5: FOLLOW INPUT – violation of the input will activate the output, and restoration of the input will deactivate the output.



For the analog input and for the 1-Wire sensor, the output control method is to be defined separately for each of the defined thresholds.

Inputs / 1-Wire sensors

The “Type”, “L Threshold”, “H Threshold” and “Tolerance” fields allow you to configure the settings of input / 1-Wire sensor. For description of parameters, see sections “Inputs” (p. 24) and “1-Wire sensors” (p. 27).

6.9 Communication

Module – type and version of the module firmware.

Module key – a string of characters for identification of the module. You can enter up to 16 alphanumeric characters (digits, letters and special characters). You can use spaces, but at least one character must be different from space. Do not program the same key for different modules. Communication between the GX Soft program and the module is possible if the keys in the program and the module are identical.

IMEI – individual identification number of the module GSM telephone.

ID – individual identification number for the purposes of communication through the SATEL server (assigned automatically by the SATEL server).

Fig. 25. “Communication” tab.

6.9.1 SATEL server

Connect to GX Control – if this option is enabled, it is possible to establish connection between the GX Control application and the module through the SATEL server.

Push notifications – if this option is enabled, the GX Control application can provide information about events by means of push notifications.

Connect to GX Soft – if this option is enabled, it is possible to establish connection between the GX Soft program and the module through the SATEL server.

i | *Make sure that the SIM card tariff plan is suited to the requirements of communication via the SATEL server (GPRS connection to the server is active at all times).*

6.9.2 Direct connection to GX Soft

Server address – address of the computer running the GX Soft program. It must be a public address. You can enter the IP address or domain name.

Port – number of the TCP port used for direct communication between the module and the computer with GX Soft program. You can enter values from 0 to 65535 (0=disabled).

Server address from SMS – if this option is enabled, the address of server, to which the module is to connect, and the port number can be entered in the content of SMS message initiating the connection. If the address is not entered, the module will connect to the computer whose address has been programmed in the module.

SMS function – the function that is run on receiving the control message. The function enables direct connection between the module and the GX Soft program to be established via GPRS.

SMS command – the control command which, if sent in the SMS message, will initiate communication between the module and the GX Soft program. You can enter up to 16 alphanumeric characters except spaces (digits, letters and special characters).

i | *The command content must be different from that of the other control commands programmed in the module.*

In the SMS message, you can include address of the computer the module is to connect to, and the number of TCP port which is to be used for communication.

6.10 Station simulation

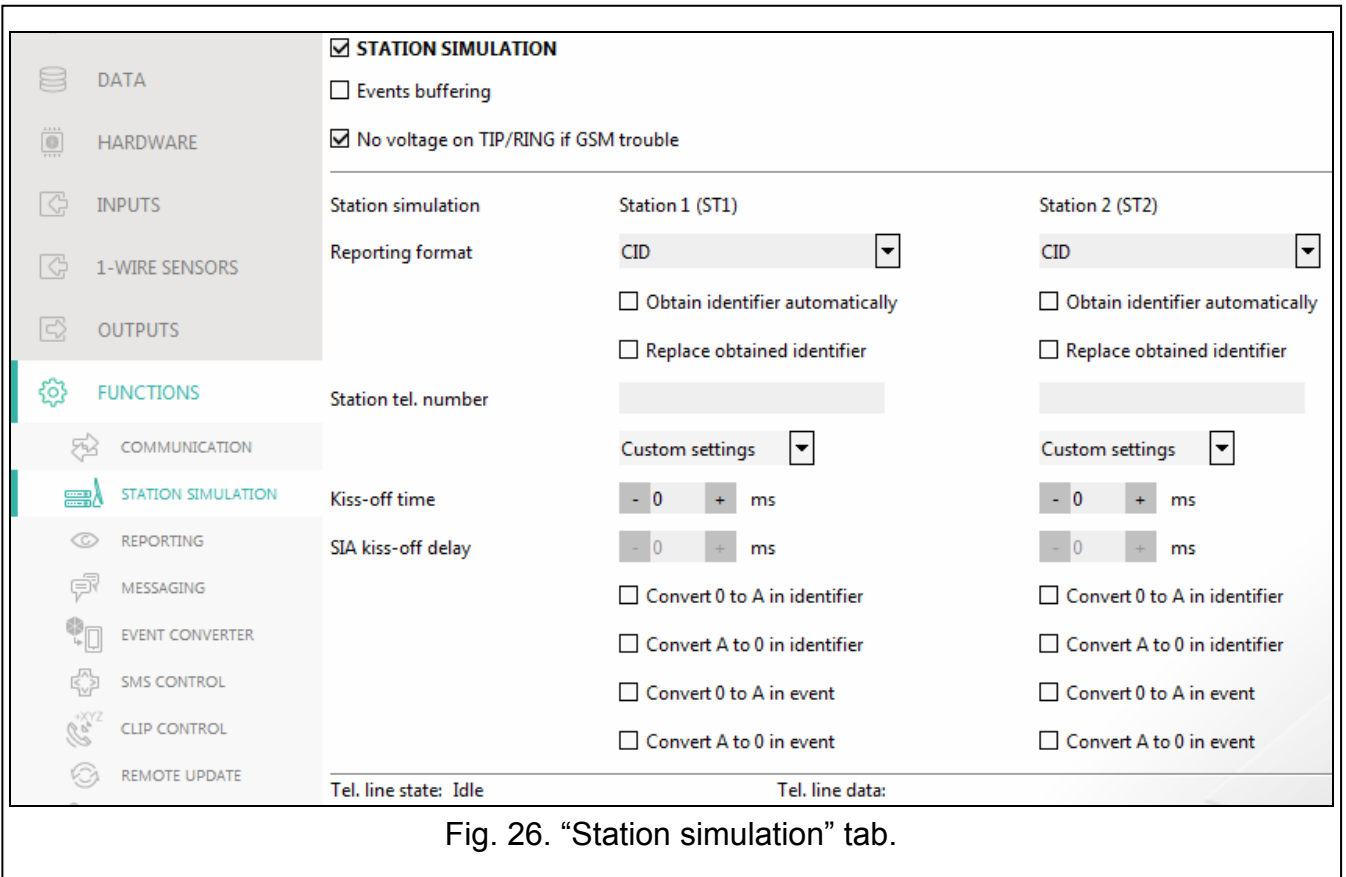

Fig. 26. “Station simulation” tab.

Station simulation – if this option is enabled, the module can receive event codes from a device connected to the telephone line output (the module simulates the monitoring station).

Events buffering – if this option is enabled, each event received by the module from the control panel is written to the module event log and confirmed immediately on receipt. If the option is disabled, events from the control panel will not be written to the module event log, and the received event will only be confirmed after the module receives acknowledgement of the event receipt by the monitoring station.

No voltage on TIP/RING if GSM trouble – if this option is enabled, voltage on the telephone line terminals will be turned off in case of the GSM telephone trouble.

Reporting format – format in which event codes are sent to the monitoring station. The following formats are supported: SIA, CID, AdemcoExpress, Sil.Knight/Ademco slow, Radionics 1400Hz, Radionics 1400Hz with parity.

Obtain identifier automatically – enable this option, if the control panel identifier is to be used by the module for module's own test transmissions. Enabling this option is not recommended when several identifiers are used by the control panel for reporting purposes (when sending a code of module related event, the identifier used last time by the control panel will be used, which means that events related to the module can be sent with different identifiers).

Replace obtained identifier – enable this option, if the module, after receiving the event code from the control panel and before sending it to the monitoring station, is to replace the identifier in event code with characters programmed in the “Module identifier” field (see “Reporting” tab p. 33).

Station tel. number – if this number is dialed by the device connected to the telephone line output, the module will be receiving the event codes. If the “Reporting” option (p. 32) is enabled in the module, the received codes can be retransmitted by the module to the

monitoring station. To define how they should be sent, select the respective reporting paths – see “Reporting priority” p. 35.



The programmed number must be unique and must not coincide with any other number programmed in the module.

[Kiss-off] – the way of configuring the “Kiss-off time” and “SIA kiss-off delay” parameters.

Custom settings – you can configure the parameters manually.

Typical settings – the parameters are configured automatically, as required by the selected reporting format (“Reporting format”).

[control panel] – the parameters are configured automatically, as required by the selected alarm control panel.

Kiss-off time – duration of the signal generated by the module to confirm receipt of the event from the control panel. The value entered must be suitable for the reporting format selected in the control panel. You can program from 0 to 9999 ms (default: 0 ms). Programming value 0 means that the kiss-off time will be programmed according to the standard of the format selected in the control panel.

SIA kiss-off delay – the time by which the acknowledgment of receipt by the module of the event in SIA format will be delayed. The value entered must be suitable for the control panel settings. You can program from 0 to 9999 ms (default: 0 ms). Programming value 0 means that the time of kiss-off delay will be programmed according to the SIA format standard.

Conversion

For events in Ademco Express and Contact ID format, you can select the following options:

Convert 0 to A in identifier – if this option is enabled, the module will convert 0 into A in the identifier of event sent to the monitoring station.

Convert A to 0 in identifier – if this option is enabled, the module will convert A into 0 in the identifier of event sent to the monitoring station.

Convert 0 to A in event – if this option is enabled, the module will convert 0 into A in the code of event sent to the monitoring station.

Convert A to 0 in event – if this option is enabled, the module will convert A into 0 in the code of event sent to the monitoring station.

Information

Tel. line mode/state – information about current handling of the telephone line output.

Tel. line data – information about the data currently being received from the device connected to the telephone line output.

6.11 Reporting

The module can send event codes to the monitoring station by using the following transmission paths:

- GPRS,
- SMS messages (module gets no acknowledgement of event code receipt).



If the “Events buffering” option is not enabled, events received by the module from the control panel have a priority over events generated by the module and their codes are sent to the monitoring station first.

Reporting – if the option is enabled, the module can send event codes to the monitoring station. The option applies to the events received by the module from the alarm control panel and the events generated by the module.

Reporting mode – the way of sending event codes to the monitoring stations:

Only Station 1 – the event codes are only sent to station 1.

Only Station 2 – the event codes are only sent to station 2.

Station 1 and Station 2 – the event codes are sent to both stations (the module must receive acknowledgement of the receipt of the code from both monitoring stations).

Station 1 or Station 2 – the module will make an attempt to send the event code to station 1 and, if unsuccessful, to station 2.

Station 2 takes over link test from station 1 – if this option is enabled when the module fails to connect to the monitoring station 1 during the connectivity test, the module will test connectivity to the monitoring station 2. The option can be enabled if the SIA-IP format is selected for both monitoring stations in the “IP format / protocol” field (see p. 33).

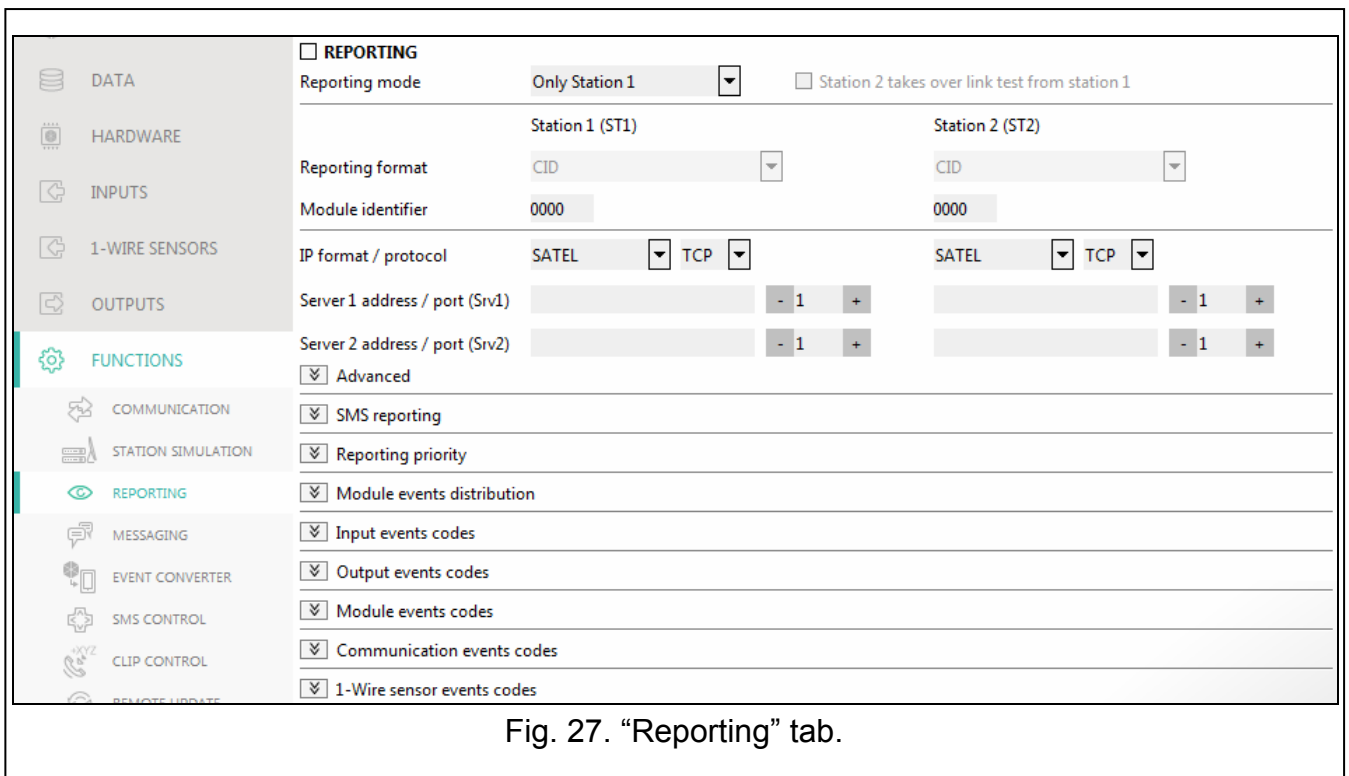

Fig. 27. “Reporting” tab.

Station 1 (ST1) / Station 2 (ST2)

Reporting format – the format in which event codes are sent to the monitoring station. The following formats are available: SIA, CID, AdemcoExpress, Sil.Knight/Ademco slow, Radionics 1400Hz, Radionics 1400Hz with parity. If the “Station simulation” option (p. 31) is enabled in the module, the field cannot be edited. If this is the case, information about the format selected in the “Station simulation” tab (see “Reporting format” p. 31) is displayed in the field. If “AdemcoExpress”, “Sil.Knight/Ademco slow”, “Radionics 1400Hz” or “Radionics 1400Hz with parity” format is selected, information that the codes are sent in 4/2 format is displayed.

Module identifier – a string of characters that enables the monitoring station to define from where the events are being sent. For the Contact ID format, it consists of 4 hexadecimal characters (digits or letters from A to F). For the SIA format, it consists of 6 hexadecimal characters (digits or letters from A to F).

IP format / protocol – for reporting via GPRS, you must define:

- format: SATEL or SIA-IP (SIA DC-09 standard).
- protocol: TCP or UDP.

Server 1/2 address / port (Srv1)/(Srv2) – in the case of GPRS reporting, enter:

- address of the monitoring station. You can enter either the IP address or the domain name.
- number of the port used for communication between the module and the monitoring station during reporting. You can enter a value from 0 to 65535.

Advanced

SATEL station key – a sequence of characters for encrypting data sent in SATEL format to the monitoring station via GPRS. You can enter up to 12 alphanumeric characters (digits, letters and special characters). If you want to enter 24 hexadecimal characters (digits or letters from A to F), enable the “hex” option.

ETHM/GPRS key – a string of characters, which is used to identify the module for the purpose of GPRS reporting in SATEL format. You can enter up to 5 alphanumeric characters (digits, letters and special characters). If you want to enter 10 hexadecimal characters (digits or letters from A to F), enable the “hex” option.

SIA-IP account number – a string of characters, which is used to identify the module for the purpose of reporting in SIA-IP format. You can enter up to 16 hexadecimal characters (digits or letters from A to F).

SIA-IP key – a sequence of characters for encrypting data sent in the SIA-IP format. You can enter up to 16 alphanumeric characters (digits, letters and special characters). If you want to enter 32 hexadecimal characters (digits or letters from A to F), enable the “hex” option.

Account prefix (L) / Receiver number (R) – a string of characters enabling the module identification scope to be expanded for the needs of reporting in SIA-IP format. You can enter up to 6 hexadecimal characters (digits or letters from A to F).

Both servers link test – if this option is enabled, the module will test connectivity to the two servers of the monitoring station. The option applies to SIA-IP format.

Supervision every – in the case of reporting in the SIA-IP format, an additional transmission can be sent at specified intervals to check link with the monitoring station. You can program a number of days, hours, minutes and seconds between the transmissions. Entering zeros only means that no additional transmission will be sent.

Server 2 takes over link test from server 1 – if this option is enabled when the module fails to connect to the monitoring station server 1 during the connectivity test, the module will test connectivity to the server 2 (according to settings provided for testing the server 1). The option applies to SIA-IP format.

Transmission period acc. to – the way of configuring the “Supervision every (Server 1)” and “Supervision every (Server 2)” parameters.

DP1 / DP2 / DP3 / DP4 – the parameters are configured automatically, as required by the EN 50136-1 standard for Dual Path Reporting.

OTHER – you can configure the parameters manually.

The options are available when the “Both servers link test” option is enabled.

Supervision every (Server 1) / Supervision every (Server 2) – number of days, hours, minutes and seconds between the tests for connectivity to servers. The fields are displayed when the “Both servers link test” option is enabled.

Encrypt – if the option is enabled, the data being sent are encrypted, and additionally the date and time are sent with event code (the monitoring station can program the date and time in the module). Option for SIA-IP format.

Send timestamp – if the option is enabled, the date and time are sent with event code (the monitoring station can program the date and time in the module). Option for SIA-IP format. It is available, when the “Encrypt” option is disabled.

Send MAC address – if this option is enabled when the event codes are sent to the monitoring station over Ethernet, the MAC address is sent together with the event code. Option for SIA-IP format.

SMS reporting

SMS reporting – tel. number – phone number of the monitoring station for SMS reporting.

SMS format – SMS format for SMS reporting. It must be defined as required by the monitoring station. The SMS message format, preset by default in the module, corresponds to the default settings of the STAM-2 monitoring station (firmware version 1.2.0 or newer) for the Contact ID format.



The STAM-2 station and SMET-256 converter do not support SMS messages in SIA format. The form of SMS message sent by the module in SIA format is #ID|CODE, where ID is 4- or 6-character identifier, and CODE is the received event code.

Reporting priority

Reporting priority – if sending an event code to the monitoring station using one transmission path fails, the module can use another transmission path. You must specify the order of using different transmission paths by the module. A successful send of the event code to the monitoring station will terminate the procedure (except for the test transmissions). For each transmission path, you can define:

Srv1 / Srv 2 – if the option is enabled, the module will try to send the event code to the address of the given server. If you select sending to the two addresses, a successful send of event code to the first address will terminate the procedure. An exception is the test transmission during which the module will try to send the event code to both servers.

Timeout – the maximum time during which the module will try to send the event code to selected addresses. If the event code is not sent during that time, the module will switch over to the next address, and then to the next path on the list.

Suspend time – the time for which reporting will be suspended, if attempts fail to send an event code through all provided transmission paths. The module will resume the attempt of establishing connection with the monitoring station after this time expires or a next, new event occurs. Up to 30 minutes can be programmed (by default: 1).

Number of retries – the number of unsuccessful retries to send the event over the given reporting path, after which the module will make an attempt to send the event over the next path. You can program from 1 to 100 (by default: 3).



The module will only use the transmission paths for which priority is specified (they are included in the list defining the order of using transmission paths).

In the case of SMS reporting, the module gets no acknowledgement of receiving the event codes by the monitoring station, hence this transmission path should be used as the last one.

Module events distribution

Define which events are to be sent to the monitoring station 1 and which to the monitoring station 2. The code of a module related event will be sent to the monitoring station only when the box next to the event description is checked. Adjust the distribution of events to the way of sending codes, selected in the “Reporting mode” field (see p. 33).

Input / Output / Module / Communication / 1-Wire sensor events codes

You can define event codes that will be sent to the monitoring station for events from the module inputs and outputs and for events related to module, 1-Wire sensors and communication. For each event, you can define codes in three formats:

4/2 [Ademco Express, Sil.Knight/Ademco slow, Radionics 1400Hz, Radionics 1400Hz with parity] – enter 2 characters (digits or letters from A to F). The event code must be consistent with the code programmed for the event in the monitoring station.

SIA – select event code consistent with SIA format by using the code editor. To open the code editor, click on the button.

Contact ID – select event code consistent with CID format by using the code editor. To open the code editor, click on the button.

6.12 Messaging

The module can send notifications about events by means of:

- SMS/push messages – the content of the messages which are to be used for notification should be saved to the module by using the GX Soft program.
- CLIP – the module provides information about event by calling the programmed phone numbers and hanging up automatically after maximum 15 seconds. CLIP provides toll-free messaging capability. The displayed module telephone number should be treated as a notification of event.

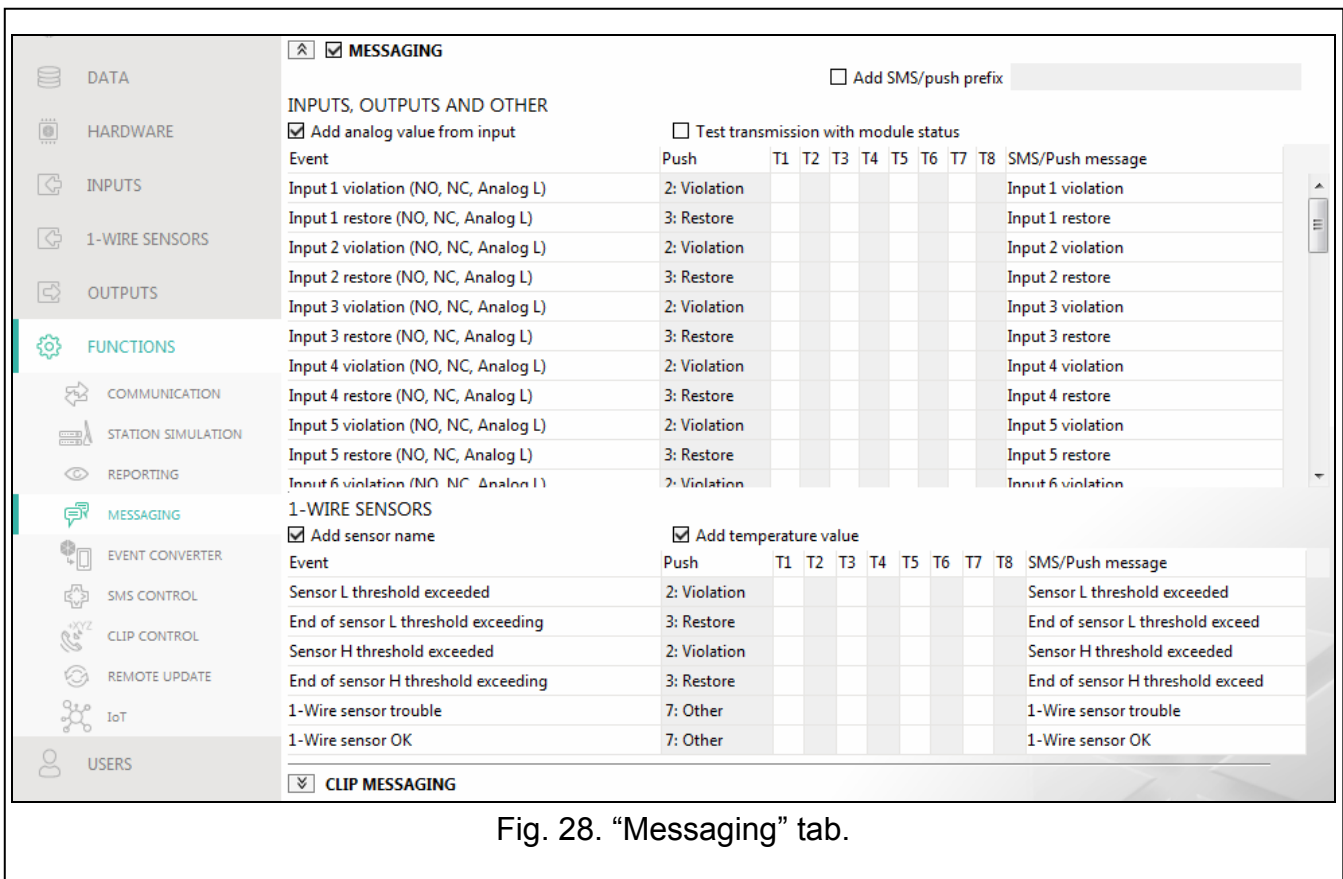

Fig. 28. "Messaging" tab.

Messaging – if this option is enabled, the module can send notifications of module related events.

Add SMS/push prefix – if this option is enabled, you can define in the adjacent field a prefix to precede the body of each message sent by the module in the SMS/push notification. The prefix can contain up to 32 characters (digits, letters and special characters).

Inputs, outputs and other

Add analog value from input – if this option is enabled, information on the current voltage value at the input will be added to the SMS message about the analog input status. If the voltage value is scaled to the physical quantity recorded by the sensor connected to the input (see “Scaling” p. 26), the scaled value (e.g. air humidity value) will be added to the SMS message.

Test transmission with module status – if this option is enabled, module status information is sent in SMS message to notify of the “Test transmission” event.

1-Wire sensors

Add sensor name – if this option is enabled, sensor name will be added to the sensor state SMS message.

Add temperature value – if this option is enabled, information on the current temperature recorded by the sensor will be added to the sensor state SMS message.

Event assignment

Event – event description.

Push – event category. You can assign the event to one of the following categories: 1: Alarm / 2: Violation / 3: Restore, / 4: Output control, / 5: Input block / 6: Diagnostics / 7: Other / 8: Push to all. Double click on the field or enter a digit from 1 to 8.

T1...T8 – messaging method selected for the given telephone (see “Users” p. 45):

[blank field] – no messaging,

s – SMS messaging,

c – CLIP messaging.

sc – SMS and CLIP messaging.

Double click on the field or enter s, c or sc to define the method of notification.

SMS/Push message – content of the SMS/push message. The message may contain up to 32 characters.



For the analog input and 1-Wire temperature sensor, the messaging parameters are to be defined separately for each of the defined thresholds.

CLIP messaging

User – user name (see “Users” p. 45).

Attempts – the number of attempts to send notification by means of CLIP to the given user telephone (see “Users” p. 45). You can enter from 0 to 15 (by default: 3).



If the “Confirmation” option is disabled, the module will make just one call, regardless of the programmed number of attempts.

Confirmation – if this option is enabled, receipt of the CLIP message by the given user is to be acknowledged. In order to acknowledge receiving the message, the connection with module must be rejected not earlier than 10 seconds and not later than 20 seconds since the telephone ring is heard. Acknowledgement of receiving the CLIP messaging will make the module stop repeating it.

SMS – if this option is enabled, failure to receive the acknowledgement of CLIP messaging will result in sending to the given user telephone number of an SMS message with content entered for this event.

6.13 Event converter

The module can notify the users of events received from the control panel in the form of event code. Notifications can be realized via:

- SMS/push messages – the text of messages to be used for notification must be saved to the module by using the GX Soft program.
- CLIP – the module will inform the users of the event by calling the programmed phone numbers and disconnecting automatically after maximum 15 seconds. CLIP offers toll-free notification. The displayed module telephone number is to be treated as event notification.

You can indicate 32 events of which the module will notify the users.

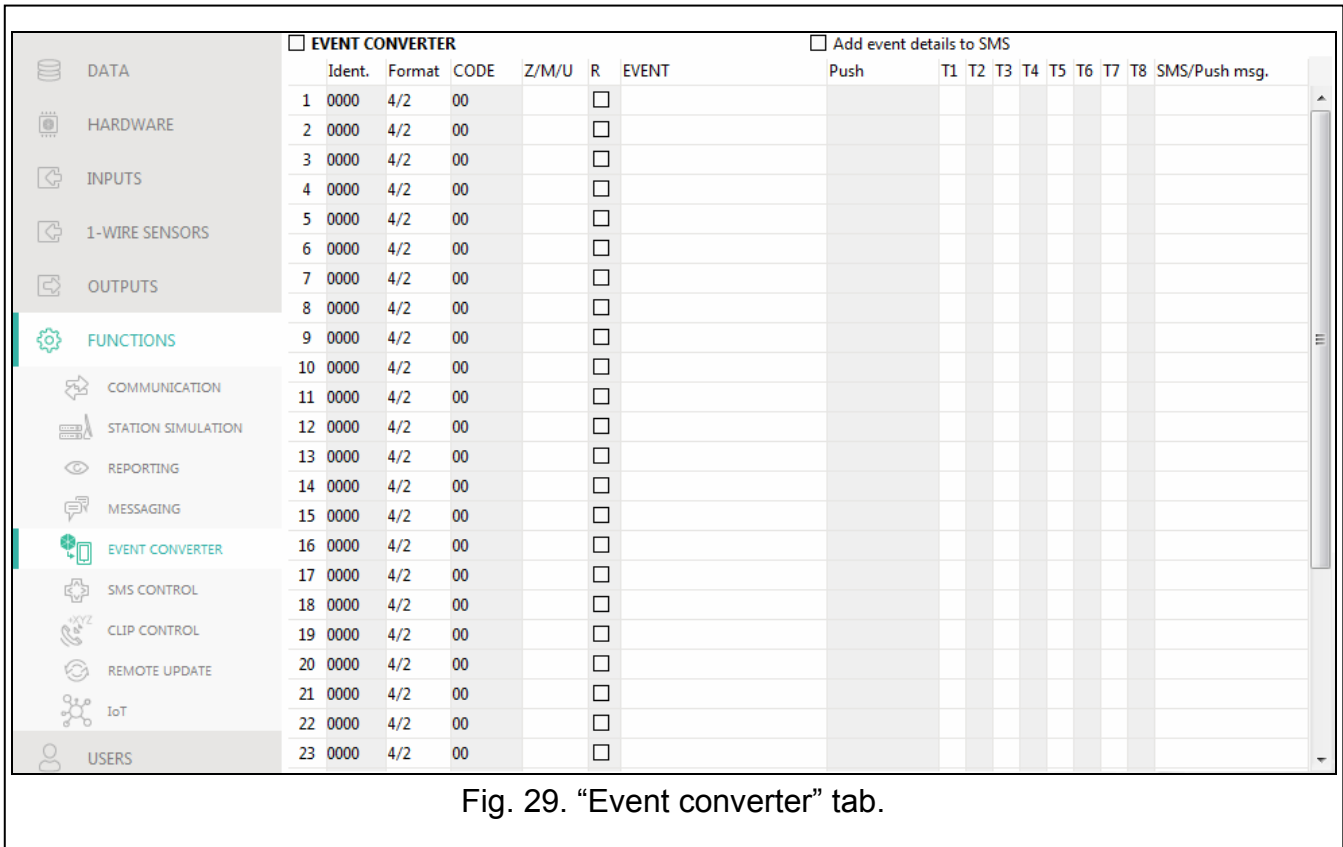

Fig. 29. "Event converter" tab.

Event converter – if this option is enabled, the module can notify the users of the events received from the control panel.

Add event details to SMS – if this option is enabled, the number of partition where the event occurred and the number of user or the number of zone that caused the event will be automatically added to the SMS message sent by the module after receiving the event code. The option only applies to event codes in Contact ID format.

Ident. – identifier that must precede the event code so that the module can send notification of the event. For 4/2 or Contact ID format, you can enter 4 characters (digits or letters from A do F). For SIA format, you can enter 6 characters. If you program no identifier, regardless of what kind of identifier is to precede the event code, receiving it will result in sending the message.

Format – format in which the event code must be received so that the module can send notification of the event. You can select: 4/2, Contact ID or SIA. Double click to change the format.

CODE – event code, after receiving of which notification of the event will be sent. For 4/2 format, enter 2 characters (digits or letters from A do F). For Contact ID or SIA format, you can use the code editor. To open the code editor window, click on the button available in the "Event" field.

Z/M/U – number of zone / module / user that must be included in the received code so that the module can send notification of the event. The field applies to SIA and Contact ID formats.

R – the option applies to Contact ID format. If it is enabled, the received event code refers to event restore / arming. If it is disabled, the received event code refers to a new event.

EVENT – event description. The field refers to SIA and Contact ID formats. It is autocompleted after entering the event code into the “CODE” field.

Push – event category. You can assign the event to one of the following categories: 1: Alarm / 2: Violation / 3: Restore, / 4: Output control, / 5: Input block / 6: Diagnostics / 7: Other / 8: Push to all. Double click on the field or enter a digit from 1 to 8.

T1...T8 – messaging method selected for the given telephone (see “Users” p. 45):

[blank field] – no messaging,

s – SMS messaging,

c – CLIP messaging,

sc – SMS and CLIP messaging.

Double click on the field or enter letter s, c or letters sc to define the messaging method.

SMS/Push msg. – the contents of SMS message which will be sent after receiving the selected event code. The message may be composed of up to 32 characters.

6.14 SMS control

You can control the module via SMS messages containing appropriate control commands.

Confirm control by sending module status – if this option is enabled, after receiving an SMS message with control command, the module will confirm the receipt by sending a return SMS message with the module status.

SMS function – function run on receiving the control command.

SMS command – the control command which, if sent in the SMS message, will run the function assigned to the command. You can enter up to 16 alphanumeric characters except spaces (digits, letters and special characters). For some functions, the command sent in the SMS message must have a specified form:

Forward USSD code – SIM – allows you e.g. to check the account balance of SIM card installed in the module. The required command form is: “**xxxxxx=yyyy.**” or “**xxxxxx=yyyy=**”, where: “xxxxxx” – control command, “yyyy” – USSD code supported by the GSM network operator. The module will use the USSD code contained in the command and will send the reply received from the operator to the telephone number from which the control command was sent.

Change test transmission period – allows you to program the interval after which a test transmission will be sent. The required command form is: “**xxxxxx=M**” or “**xxxxxx=H:M**”, where: “xxxxxx” – control command, “M” – number of minutes after which the transmission will always be sent, “H:M” – hour and minute when the transmission will be sent once a day (enter Greenwich Mean Time (GMT)).

Change user 1...8 tel – allows you to program the number of telephone user. The required command form is: “**xxxxxx=yyyy.**” or “**xxxxxx=yyyy=**”, where: “xxxxxx” – control command, “yyyy” – new number of telephone user. It is recommended that the telephone number be preceded by the country code.



The content of control commands must vary.

The content of one control command must not be inserted into the content of another command.

It is not advisable to use the advanced functions available due to the USSD service if menu is presented in response to the entered code.

The control command for sending USSD codes can be used for sending SMS messages through the module.

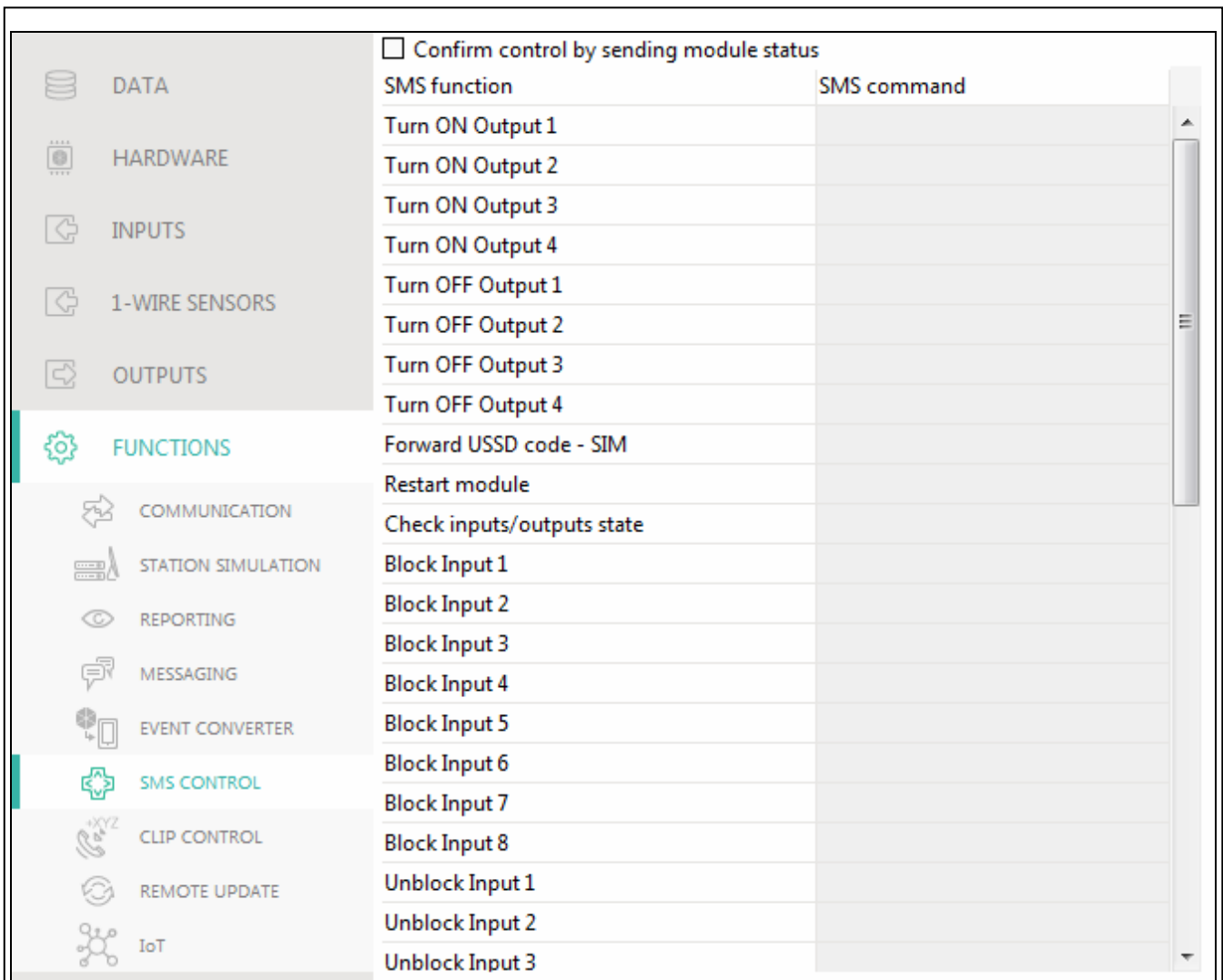

Fig. 30. "SMS Control" tab.

6.15 CLIP control

You can control the module outputs by using the CLIP service.

Any telephone

You can program how the module outputs are to be controlled by using the CLIP service from any phone number.

i *The numbers from the "Additional telephone numbers" list and the users' telephone numbers are not treated by the module as any telephone numbers.*

Users

You can program how the module outputs are to be controlled by using the CLIP from the users' telephones (see "Users" p. 45).

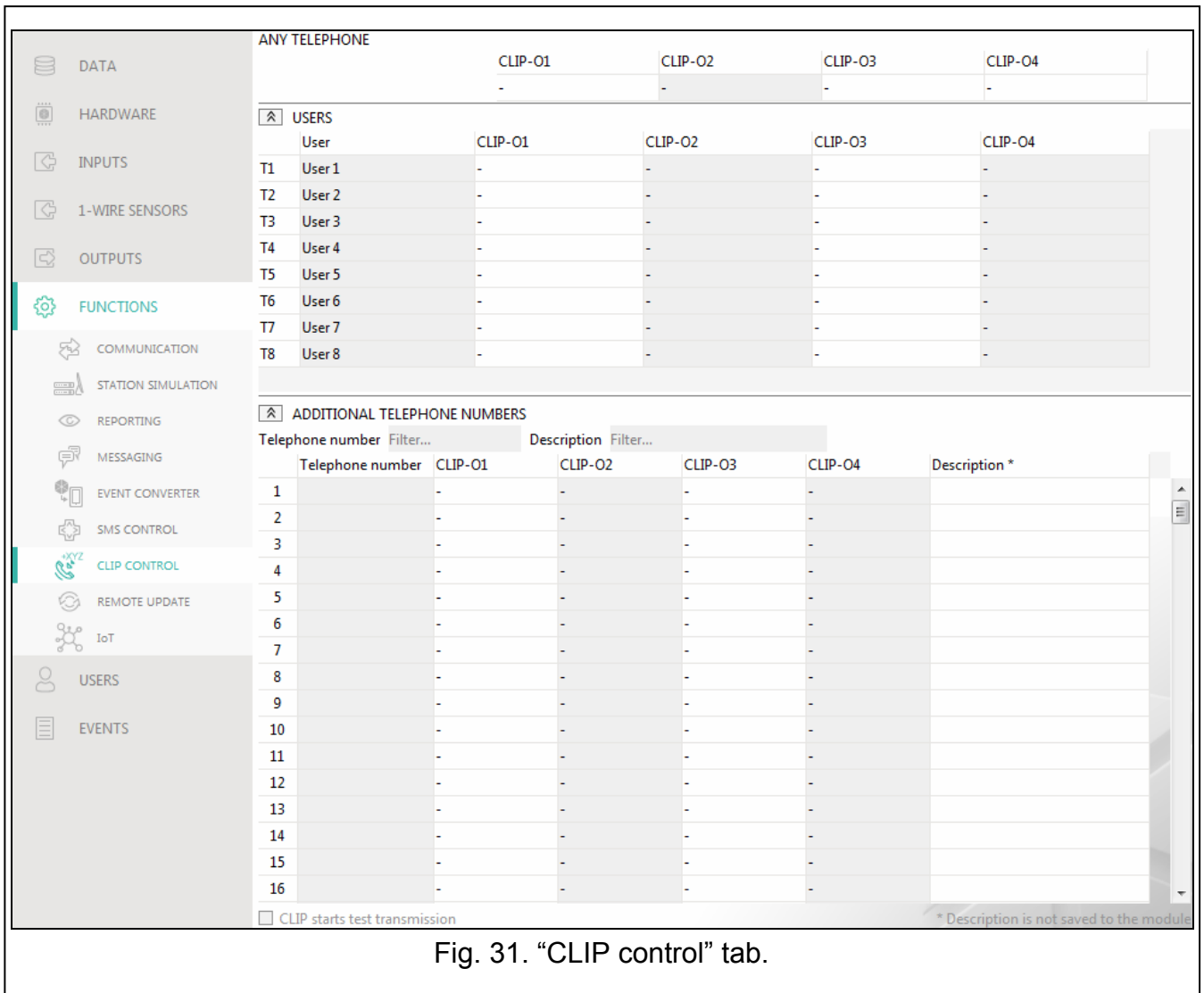

Fig. 31. “CLIP control” tab.

Additional telephone numbers

You can program how the module outputs are to be controlled by using the CLIP from additional phone numbers.

Telephone number [Filter...] – enter the phone number or part of it to filter the list.

Description [Filter...] – enter the text describing the phone number or part of it to filter the list.

Telephone number – you can program 1024 phone numbers to control the outputs by using CLIP. You can program the whole telephone number (including the country code) or only part of it. Up to five characters (consecutive digits from any part of the number, including “+”) can be treated as part of the number. Six and more characters will be interpreted by the module as the whole telephone number.

Description – you can enter description of the given telephone number. The description may contain up to 32 characters (digits, letters and special characters). The description is not saved to the module.

Output control

CLIP-01...04 – the output can respond to CLIP in one of the following ways:

- CLIP does not control the output.
- 1: ON** – CLIP will turn on the output.
- 2: OFF** – CLIP will turn off the output.

3: ON FOR TIME – CLIP will turn on the output for a specified period of time (see “Operating time” parameter p. 29).

4: TOGGLE – CLIP will switch the output to its opposite state.

If several different responses to CLIP from one telephone number are programmed for the given output (e.g. O1) (when the number or part of it is programmed in two or more rows of the table), then in response to CLIP from that number the output will be switched over successively to each of the programmed states. The switching sequence will correspond to the consecutive numbers from the telephone list.

You can sort the data in the table. If you click on the selected column header (e.g. “Telephone number”), the table will be sorted by the data in that column. The symbol indicating the current sorting method (^ – ascending, v - descending) will be displayed in the column header.

CLIP starts test transmission – information about additional reaction of the module to CLIP.

If the option is enabled, a test transmission will be additionally started by the module in response to CLIP. You can enable/disable this option in the “Mainboard” tab (see “CLIP starts test transmission” p. 21).

6.16 Remote update

Remote update of the module firmware is made possible by the “UpServ” update server, which is included in the SATEL product portfolio.

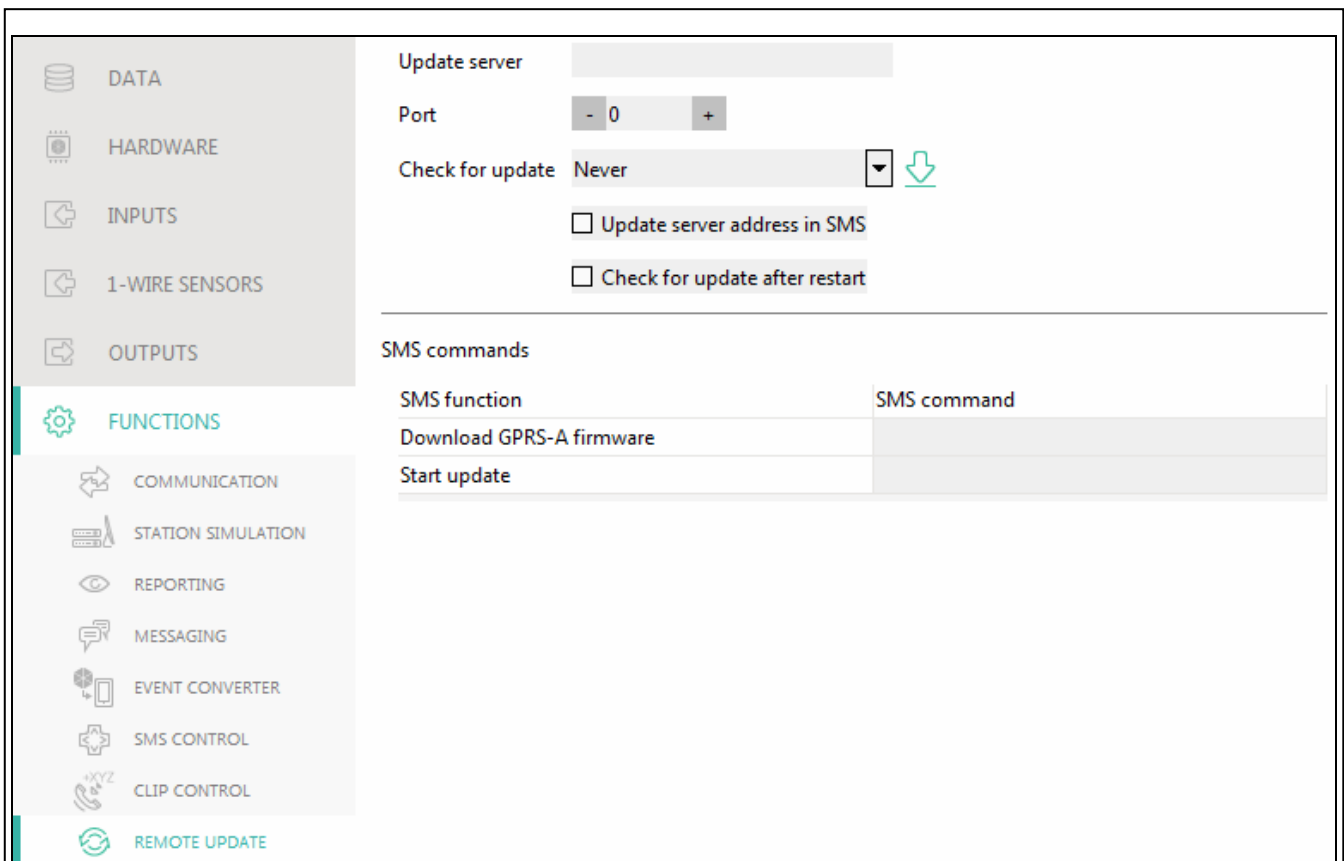

Fig. 32. “Remote update” tab.

Update server – address of the “UpServ” update server. You can enter the IP address or domain name.

Port – number of the TCP port used for communication with the “UpServ” update server. You can enter values from 0 to 65535 (0=disabled).

Check for update – you can select how often the module will check for a new firmware version: Never, Everyday, Once per week or Once per month.



– click to start remote firmware update.

Update server address in SMS – if this option is enabled, you can enter server address and port number in the SMS message initiating the firmware download from the update server. If the message contains no address or port number, the module will use the preprogrammed settings.

Check for update after restart – if this option is enabled, the module will connect to the update server after each restart and check if a new firmware version is available.

SMS commands

SMS function – function run after control command is received. The functions are used for remote update of the module.

SMS command – the control command which, if sent in the SMS message, will start the function. You can enter up to 16 alphanumeric characters except spaces (digits, letters and special characters).



The content of control commands must vary.

The content of one control command must not be inserted into the content of another command.

If you program the command initiating firmware download without programming the command that initiates update of the firmware, the update will start automatically after the download is completed.

6.17 IoT

The module can work as part of the Internet of Things (IoT). This enables the module to be integrated with other systems (including automation or measurement data acquisition) to transfer the module registered data to them and receive the control commands for the module from them. GPRS is used for communication.

IoT – if the option is enabled, the module can communicate with the IoT devices.

[Protocol] – protocol used for communication. You can select from MQTT, JSON and MODBUS RTU. Format of data sent by using each protocol – see “Appendix” p. 51.

Server – address of the server to which the module is connect when working as part of the Internet of Things. You can enter IP address or domain name.

Port – number of TCP port used for communication with the server. You can enter values from 1 to 65535.

Use Secure Socket Layer (SSL) – if this option is enabled, communication with the server will be encrypted. If communication on the server side is not encrypted, the option should be disabled.

Options

Options are only available for the “MQTT” and “JSON” protocols.

Always connected – if this option is enabled, the module, after sending the data, will maintain connection to the server until the next transmission. If the option is disabled, the module, after sending the data, will wait a few seconds for a response from the server and terminate the connection. Connection to the server will then be established during the next transmission. The time between subsequent transmissions is defined in the “Polling” field.

Send after input/1-Wire sensor violating/threshold exceeding – if this option is enabled, violation / threshold exceeding in case of input / 1-wire sensor will start data transmission.

Send after output state changing – if this option is enabled, changing the output state will start data transmission.

i | Each data transmission will reset the countdown before sending the next cyclic data transmission (“Polling” field).

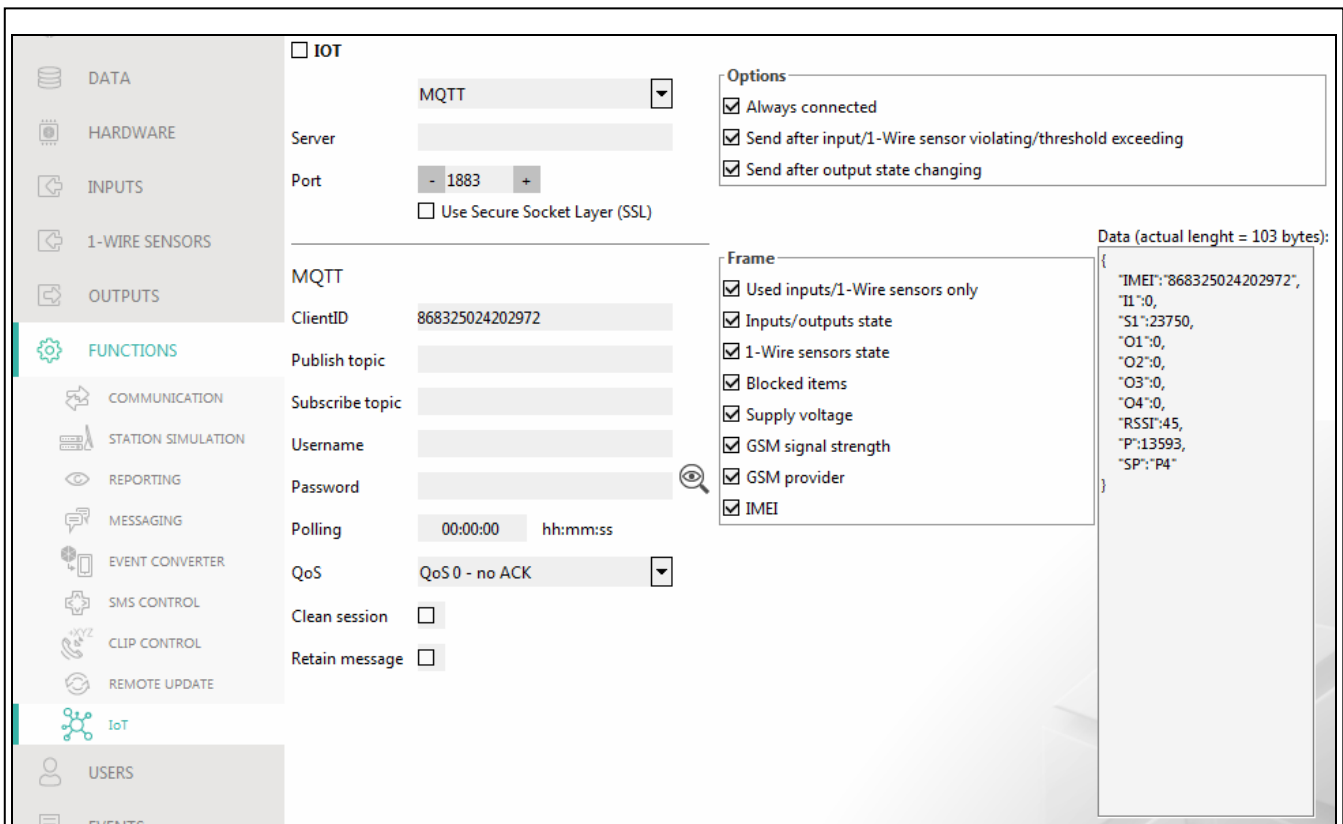

Fig. 33. “IoT” tab.

Frame

You can define the type of data the frame sent by the module will contain (for a detailed description of the data to be sent, see “Format of frame sent by the module” p. 51). Options are only available for the “MQTT” and “JSON” protocols.

Used inputs/1-Wire sensors only – if this option is enabled, the frame will only contain data from the inputs / 1-Wire sensors being in use.

Inputs/outputs state – if this option is enabled, the frame will contain information about the state of inputs / outputs.

1-Wire sensors state – if this option is enabled, the frame will contain information about temperature from 1-Wire sensors.

Blocked items – if this option is enabled, the frame will contain information about blocked inputs / 1-Wire sensors.

Supply voltage – if this option is enabled, the frame will contain information about the module supply voltage.

GSM signal strength – if this option is enabled, the frame will contain information about the strength of radio signal received by the module.

GSM provider – if this option is enabled, the frame will contain the symbol of selected GSM network operator.

IMEI – if this option is enabled, the frame will contain the identification number of the module GSM communicator.

i | Enabling / disabling the option will update the data displayed in the “Data” field.

Data (actual length = [number] bytes) – information about the type of data that will be contained in the frame sent by the module (see “Format of frame sent by the module” p. 51). Information about the current size of the frame is displayed above the field.

6.18 Users

You can enter data of 8 users. It will be possible to control the module from the user telephone number by using SMS messages (see p. 39), CLIP (see p. 40) and through the GX Control application (see p. 46). At the same time, the module can send notifications (SMS and CLIP) of the events (see p. 36) to the user telephone number.

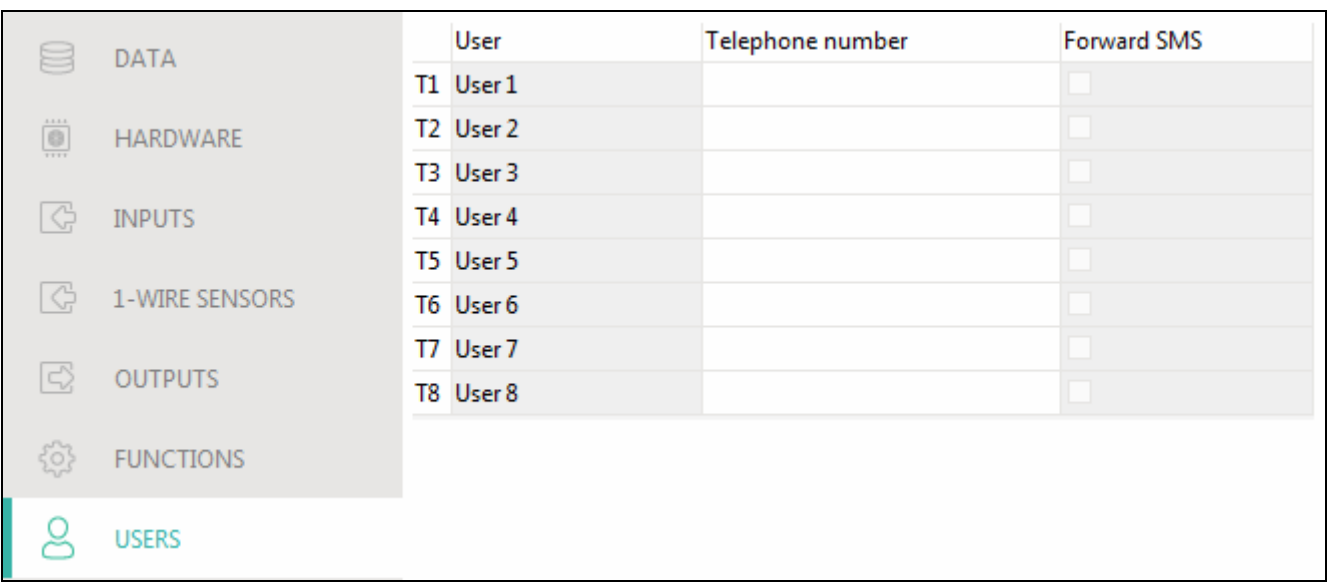

	User	Telephone number	Forward SMS
T1	User 1		<input type="checkbox"/>
T2	User 2		<input type="checkbox"/>
T3	User 3		<input type="checkbox"/>
T4	User 4		<input type="checkbox"/>
T5	User 5		<input type="checkbox"/>
T6	User 6		<input type="checkbox"/>
T7	User 7		<input type="checkbox"/>
T8	User 8		<input type="checkbox"/>

Fig. 34. “Users” tab.

User – individual name of the user (up to 16 characters).

Telephone number – the user telephone number. You can program the whole telephone number (including the country code) or only part of it. Up to five characters (consecutive digits from any part of the number, including “+”) can be treated as part of the number. Six and more characters will be interpreted by the module as the whole telephone number.

Forward SMS – if this option is enabled, unknown SMS messages received by the module are forwarded to the user phone number (e.g. information received from the GSM network operator).

6.19 Events

Up to 500 events generated by the module or received from the control panel can be recorded in the module non-volatile memory.

Clear module event log – click to clear the module event log.

Refresh – click to refresh the list of events.

Events are shown sorted by time in descending order (the latest UP, the oldest DOWN). Individual columns present the following information:

No. – consecutive event number.

Date – date the event occurred in the module / event from the control panel was saved to the module memory (see “Events buffering” p. 31).

Time – hour the event occurred in the module / event from the control panel was saved to the module memory (see “Events buffering” p. 31).

Description – event description (for events in Contact ID or SIA format).

Source – name of source that generated the event.

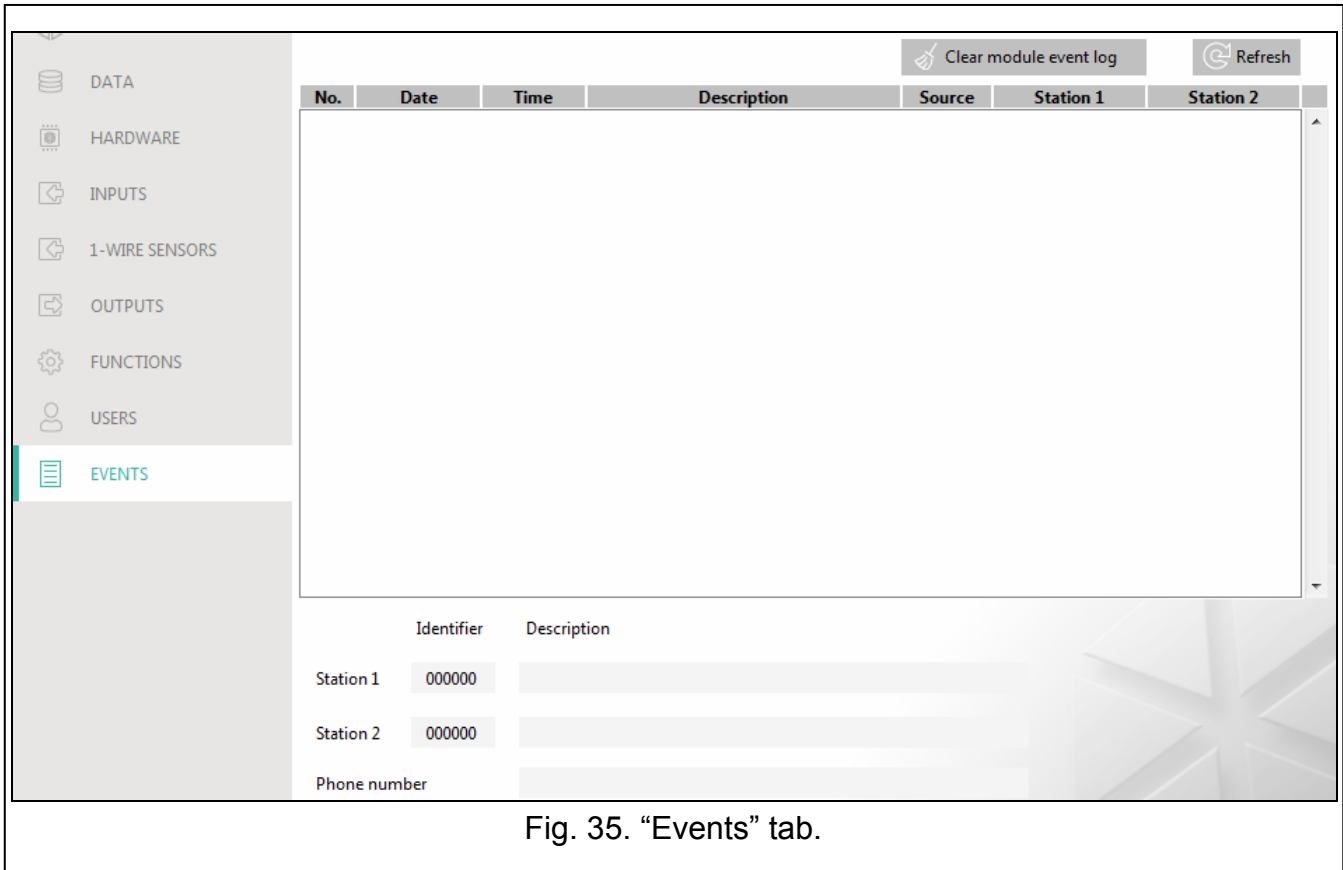

Fig. 35. "Events" tab.

Station 1 / Station 2 – reporting status:

[blank field] – event is not reported,

. – event waiting to be sent to the monitoring station,

+ – test transmission sent to the monitoring station,

- – sending test transmission has failed,

* – sending event cancelled (e.g. reporting has been disabled),

[name of reporting path] – event sent successfully to the monitoring station using the given transmission path.

7. GX Control application

The GX Control is a mobile application that allows you to remotely operate GSM-X and GPRS-A module, i.e.:

- check the status of inputs, 1-Wire sensors and outputs,
- block / unblock the inputs and 1-Wire sensors,
- control the outputs,
- view the troubles,
- view the event log.

Additionally, the application can provide information on the events by using push notifications.

Communication between the application and the module is encrypted.



Number of the telephone with GX Control application must be programmed in the module in the list of users' telephones (see "Users" p. 45).

You can download the application from the internet stores: “Google play” (Android system devices) or “App Store” (iOS system devices).

When the application is run for the first time, a prompt is displayed asking you whether access to the application is to be password protected. After you define the application access rules, a tutorial will be displayed to prompt you what to do to configure settings for communication with the module. For a new module, the settings can be configured automatically, or you can enter them manually. Fig. 36 shows the GX Control screen that allows you to select how the communication settings are to be configured.

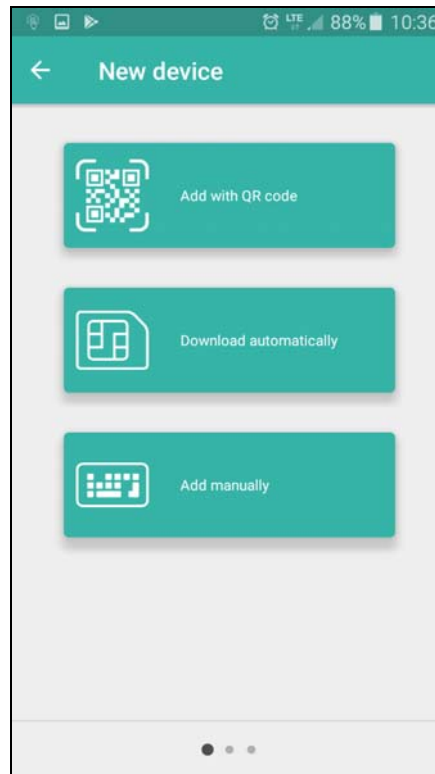

Fig. 36. GX Control application (Android system): select how to configure the settings for a new module.

Add with QR code

Pressing the button will start the QR code scanner to enable communication settings to be read from the QR code (see p. 20).

If the communication settings are configured on one mobile device, they can be easily copied to another mobile device. Just display the QR code on the device in which the settings for communication with the given module are already configured, and read the code on another device.

Download automatically

Pressing the button will display a window in which you are to enter the GSM telephone number of a new module. Communication settings will be downloaded automatically from the module.

Add manually

Allows you to manually configure the settings for communication with the module. Pressing the button will display a window (Fig. 37), in which you must:

- enter the module name (to enable identification of the module when using the application),

- enter the IMEI number of the module GSM communicator (the individual identification number of the GSM communicator),
- enter the module ID number (the individual identification number for the purpose of communication via the SATEL server – see “Project” p. 19),
- enter the user phone number (number programmed in the module – see “Users” p. 45),
- select the icon (to facilitate identification of the module when using the application).

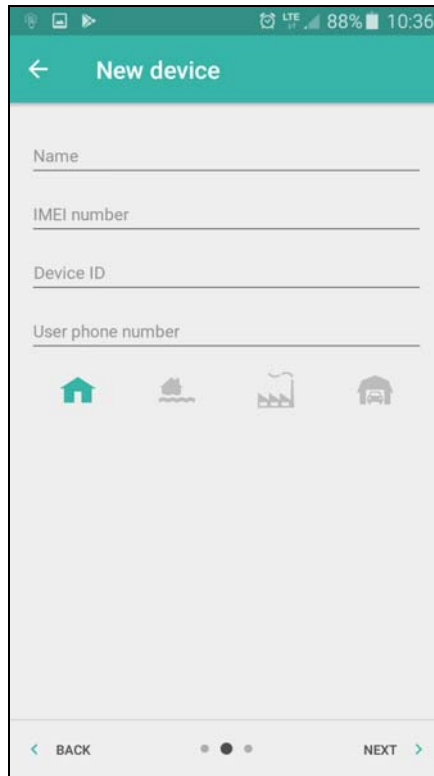

Fig. 37. GX Control application (Android system): manual configuration of new module settings.

8. Control by using a telephone

8.1 SMS control

Required settings

- Program the control commands (see section “SMS control” p. 39).
- If the control availability is to be limited to the telephones whose numbers have been programmed in the module for users (see “Users” p. 45), enable the “Users tel. numbers” option (p. 20).
- If module is to confirm execution of the control command by means of SMS message, program SMS center number (see “SMS center number” p. 22) and enable the “Confirm control by sending module status” option (p. 39).

Control

1. Send the SMS message containing a control command to the telephone number of GSM module.



The control command may be just a fragment of the SMS message, but it must be among the first 32 characters. This makes it possible to write the control command, including the comments, to the telephone memory and send the whole to the module.

Several control commands may be included in one SMS message (should be separated by spaces).

- If the “Confirm control by sending module status” option (p. 39) is enabled, after execution of the command the module will send an SMS message with the information on module status:

“OT=????, IN=????????, AC=?, SIG=?, P=?, ??:?? / ??d??h??m, T1=??, T2=??, T3=??, T4=??, T5=??, T6=??, T7=??, T8=??,”

where:

OT – information on output status [o – output OFF; O – output ON].

IN – information on input status [i or t – input in normal state; I or T – input violated; b – input blocked].

AC – information on AC input status [i – alternate voltage present; I – no alternate voltage].

P – information on the current module supply voltage [V].

SIG – actual level of signal received by antenna [digits from 0 to 4].

?:?:? / ??d??h??m – information on every how many days, hours and minutes the module sends the test transmission [once a day at e.g. 15:10 / number of days (d), hours (h) and minutes (m)].

T1...T8 – information on the user telephone numbers programmed in the module.

8.2 CLIP control

Using the CLIP you can only control the status of outputs.

Required settings

- Enter the telephone numbers from which control of the outputs will be possible by means of CLIP (see section “CLIP control” p. 40).
- Define from which telephone numbers and how the outputs are to be controlled by CLIP (see “CLIP-O1...O4” p. 41).

Control

Call the module GSM telephone number and hang up after hearing the ring signal. The module will change the output state. If the “Send SMS with module state on CLIP” option (p. 21) is enabled in the module, the module will send an SMS with module state information to your telephone number. If the “Send SMS with 1-Wire sensors state on CLIP” option is enabled in the module (p. 21), the module will send to your telephone number an SMS message with information about the current temperatures recorded by the 1-Wire sensors.

9. Module firmware update



When the firmware update is running, the module does not execute its normal functions.

Before the firmware update, make sure the module settings have been saved to a configuration file.

9.1 Local update

1. Download the update program for GPRS-A module firmware from www.satel.eu.
2. Connect the module RS-232 (TTL) port with the computer port using the USB-RS converter offered by SATEL.
3. Run the update program for module firmware.
4. Click on the  button.
5. When a prompt window is displayed asking you whether to continue the firmware update, click "Yes". The firmware of module will be updated.

9.2 Remote update

1. Program the parameters for remote update of the module firmware in the module (see "Remote update" p. 42).
2. Initiate the update from the GX Soft program (see p. 43) or by using an SMS message.

9.2.1 Initiating the update by using SMS message



The SMS messages which initiate the download and update of firmware can only be sent from an authorized telephone number (see "Tel. numbers verification (SMS control and answer to CLIP)" p. 20).

1. Send to the number of SIM card used by the module an SMS message containing control command to initiate firmware download from the "UpServ" update server (see "SMS command" p. 43). If the "Update server address in SMS" option is enabled in the module and you want the module to connect to an update server other than that indicated in the module settings, the message should look like this: **xxxx=aaaa:pp=** ("xxxx" – control command; "aaaa" – server address (IP address or domain name); "pp" – port number).
2. Completion of the new firmware download will be indicated by the module with an SMS message.
3. Send an SMS message containing the control command to initiate the module firmware update (see "SMS command" p. 43). If the update initiating control command has not been programmed in the module, the firmware update process will be started automatically by the module after the download is completed.
4. Completion of the module firmware update will be indicated by the module with an SMS message.

10. Restoring the factory settings

1. Click on the "Data" tab in the GX Soft program.
2. Click on "Factory settings" button. You will be prompted whether to restore the factory settings.
3. Click on "Yes".

11. Specifications

Number of inputs.....	8
Number of outputs	OC type2
	relay, NO type2
Supply voltage	12 V DC ±15%

Standby current consumption	80 mA
Maximum current consumption	220 mA
Maximum permissible voltage on AC input	25 V AC
O1...O2 outputs (OC type)	50 mA / 12 V DC
O3...O4 outputs (relay, NO type).....	1000 mA / 30 V DC
Environmental class according to EN50130-5	II
Operating temperature range.....	-10...+55°C
Maximum humidity	93±3%
Enclosure dimensions.....	83 x 65 x 23 mm
Weight.....	110 g

12. Appendix

12.1 Data format for JSON and MQTT protocol

12.1.1 Format of frame sent by the module

```
{ "IMEI": "868325024202972", "I1": 11841, "BI2": 1, "I3": 0, "I4": 0,
  "I5": 0, "I6": 0, "I7": 0, "I8": 0, "AC": 0, "S1": 0, "BS2": 1, "S3": 0,
  "S4": 0, "S5": 0, "S6": 0, "S7": 0, "S8": 0, "O1": 1, "O2": 0, "O3": 1,
  "O4": 0, "RSSI": 64, "P": 13692, "SP": "P4" }
```

- IMEI** – individual identification number of the module GSM telephone.
- I1...I8** – input state (NO [0 = not violated, 1 = violated], NC [1 = not violated, 0 = violated]) / value on the analog input (scaled and multiplied by 1000).
- BI1...8:1** – input blocked.
- AC** – AC input state (0 = not violated [AC voltage present], 1 = violated [no AC voltage]).
- BAC:1** – AC input blocked.
- S1...S8** – value from the 1-Wire digital temperature sensor (multiplied by 1000).
- BS1...8:1** – 1-Wire temperature sensor blocked.
- O1...O4** – output state (0=OFF, 1=ON).
- RSSI** – indicator of received radio signal strength in percent.
- P** – value of the module supply voltage (multiplied by 1000).
- SP** – currently selected GSM network operator.

12.1.2 Format of the module control frame

You can use the JSON and MQTT protocol to send to the module a frame with control command:

- “BIX”:1 / “BIX”:0** – block / unblock input, where: X = input number from 1 to 8.
- “BAC”:1 / “BAC”:0** – block / unblock AC input.
- “BSX”:1 / “BSX”:0** – block / unblock 1-Wire temperature sensor, where: X = sensor number from 1 to 8.
- “OX”:1 / “OX”:0** – activate/deactivate output, where: X = output number from 1 to 4.

- "MOX":1 / "MOX":0** – activate/deactivate output and save its state, where: X = output number from 1 to 4 (after module restart or power supply failure, the output will be switched to the state saved).
- "TOX":1** – activate output for the time preset in the module (see "Operating time" p. 29), where: X = output number from 1 to 4.

A frame sent to the module may contain several control commands arranged in any order; see the example below:

```
{"MO3":0, "O2":1, "TO5":1, "BI2":1, "BS1":0, "BAC":1}
```

where:

- "MO3":0** – deactivate output 3 and save its state,
"O2":1 – activate output 2,
"TO4":1 – activate output 4 for the time preset in the module,
"BI2":1 – block input 2,
"BS1":0 – unblock sensor 1 on 1-Wire bus,
"BAC":1 – block AC input.

12.2 Table of MODBUS RTU protocol registers

Register	Value	R/W
ANALOG INPUT		
0	Voltage - input 1 H	R
1	Voltage - input 1 L	R
2	Voltage - input 2 H	R
3	Voltage - input 2 L	R
4	Voltage - input 3 H	R
5	Voltage - input 3 L	R
6	Voltage - input 4 H	R
7	Voltage - input 4 L	R
8	Voltage - input 5 L	R
9	Voltage - input 5 H	R
10	Voltage - input 6 L	R
11	Voltage - input 6 H	R
12	Voltage - input 7 L	R
13	Voltage - input 7 H	R
14	Voltage - input 8 L	R
15	Voltage - input 8 H	R
16	Supply voltage H	R
17	Supply voltage L	R
1-Wire		
18	1-Wire - sensor 1 H	R

19	1-Wire - sensor 1 L	R
20	1-Wire - sensor 2 H	R
21	1-Wire - sensor 2 L	R
22	1-Wire - sensor 3 H	R
23	1-WIRE - sensor 3 L	R
24	1-Wire - sensor 4 H	R
25	1-Wire - sensor 4 L	R
26	1-Wire - sensor 5 H	R
27	1-Wire - sensor 5 L	R
28	1-Wire - sensor 6 H	R
29	1-Wire - sensor 6 L	R
30	1-Wire - sensor 7 H	R
31	1-Wire - sensor 7 L	R
32	1-Wire - sensor 8 H	R
33	1-Wire - sensor 8 L	R

VIOLATIONS

34	Violation state - input 1	R
35	Violation state - input 2	R
36	Violation state - input 3	R
37	Violation state - input 4	R
38	Violation state - input 5	R
39	Violation state - input 6	R
40	Violation state - input 7	R
41	Violation state - input 8	R
42	Supply voltage	R
43	Violation state - 1-Wire 1	R
44	Violation state - 1-Wire 2	R
45	Violation state - 1-Wire 3	R
46	Violation state - 1-Wire 4	R
47	Violation state - 1-Wire 5	R
48	Violation state - 1-Wire 6	R
49	Violation state - 1-Wire 7	R
50	Violation state - 1-Wire 8	R

OUTPUTS

51	State of output 1	R
52	State of output 2	R
53	State of output 3	R
54	State of output 4	R

TELEPHONE

55	GSM signal quality	R
----	--------------------	---

R – read, W – write.

13. Manual update history

Date	Firmware version	Introduced changes
2018-05	1.02	<ul style="list-style-type: none"> Information on “Send SMS with 1-Wire sensors state on CLIP” option has been added (p. 21). Description of 1-Wire sensor state has been added (p. 26). Information on “Correction” 1-Wire sensor parameter has been added (p. 27). Information on how to control output by using input has been added (p. 29). Information about “Station simulation” option has been added (p. 31). Description of “Station tel. number” field has been modified (p. 31). Description of “Kiss-off” field has been added (p. 32). Description of “Tel. line mode/state” and “Tel. line data” fields has been added (p. 32). Description of “Reporting format” field has been modified (p. 33). Description of “Transmission period acc. to” field has been added (p. 34) Description of “Add SMS/push prefix” field has been added (p. 36). Description of SMS and CLIP messaging has been added (p. 37). Descriptions of “Send after input/1-Wire sensor violating/threshold exceeding” and “Send after output state changing” options have been added (p. 43). Descriptions of options to define frames in “MQTT” and “JSON” format have been added (p. 44).