

Alarm Control Panel

PERFECTA

Firmware Version 1.02

Satel® 



INSTALLER MANUAL

SATEL sp. z o.o.
ul. Budowlanych 66
80-298 Gdańsk
POLAND
tel. +48 58 320 94 00
www.satel.eu

WARNINGS

The security alarm system should be installed by qualified personnel.

Prior to installation, please read carefully this manual in order to avoid mistakes that can lead to malfunction or even damage to the equipment.

Disconnect power before making any electrical connections.

Changes, modifications or repairs not authorized by the manufacturer shall void your rights under the warranty.

SATEL's goal is to continually upgrade the quality of its products, which may result in some changes of their technical specifications and firmware. The current information on the introduced modifications is available on our website.

Please visit us:
<http://www.satel.eu>

Hereby, SATEL sp. z o.o., declares that this control panel is in compliance with the essential requirements and other relevant provisions of Directive 2014/53/EU. The declaration of conformity may be consulted at www.satel.eu/ce

The following symbols may be used in this manual:



- note,



- caution.

Changes made to the firmware version 1.02

Expansion modules

The PERFECTA 16 and PERFECTA 32 control panels support INT-RX-S module (433 MHz keyfobs receiver expansion module).

CONTENTS

| | |
|---|-----------|
| 1. Introduction | 3 |
| 2. Features | 3 |
| 3. Keypads | 5 |
| 3.1 Keypads features..... | 6 |
| 4. Expansion modules | 6 |
| 5. Wireless devices PERFECTA 16-WRL / PERFECTA 32-WRL | 6 |
| 6. System installation | 6 |
| 6.1 Installation plan..... | 7 |
| 6.2 Estimation of the system current consumption..... | 7 |
| 6.3 Cabling..... | 7 |
| 6.4 Installation of control panel..... | 7 |
| 6.4.1 Description of the mainboards..... | 8 |
| 6.5 Connecting devices to the communication bus..... | 9 |
| 6.5.1 Connecting keypads..... | 10 |
| 6.5.2 Connecting 433 MHz keyfobs receiver expansion module PERFECTA 16 / PERFECTA 32..... | 11 |
| 6.5.3 Connecting the hardwired zone expanders..... | 11 |
| 6.5.4 Connecting the hardwired output expander..... | 13 |
| 6.6 Connecting detectors and other devices to the zones..... | 13 |
| 6.7 Connecting the sirens..... | 14 |
| 6.8 Connecting the microphone..... | 15 |
| 6.9 Connecting the power supply and starting the control panel..... | 15 |
| 6.9.1 Main power supply..... | 15 |
| 6.9.2 Backup power supply..... | 16 |
| 6.9.3 Control panel power-up / start-up procedure..... | 16 |
| 6.9.4 Starting the service mode..... | 16 |
| 6.9.5 Emergency procedure of the control panel start-up..... | 17 |
| 6.9.6 First steps after starting-up the control panel..... | 17 |
| 6.10 Programming addresses for the hardwired keypads..... | 17 |
| 6.10.1 Programming the address by means of the service function..... | 18 |
| 6.10.2 Programming the address without entering the service mode..... | 18 |
| 6.11 Identification of devices connected to the bus..... | 18 |
| 6.11.1 Starting the identification function from keypad..... | 18 |
| 6.11.2 Starting the identification function from PERFECTA SOFT program..... | 19 |
| 6.12 Installing the SIM card..... | 19 |
| 6.13 Connecting the computer to the control panel..... | 19 |
| 6.14 Installation of wireless devices PERFECTA 16-WRL / PERFECTA 32-WRL..... | 20 |
| 6.14.1 Adding new wireless devices..... | 20 |
| 6.14.2 Removing wireless devices..... | 21 |
| 7. Numeration of zones and outputs in the system | 22 |
| 7.1 Numeration of zones..... | 22 |
| 7.1.1 Hardwired zones..... | 22 |
| 7.1.2 Wireless zones PERFECTA 16-WRL / PERFECTA 32-WRL..... | 22 |
| 7.2 Numeration of outputs..... | 23 |
| 7.2.1 Hardwired outputs..... | 23 |
| 7.2.2 Wireless outputs PERFECTA 16-WRL / PERFECTA 32-WRL..... | 23 |
| 8. Specifications | 23 |
| 8.1 Control panel..... | 23 |
| 8.2 PRF-LCD keypad..... | 24 |
| 9. Manual update history | 24 |

1. Introduction

This manual describes the PERFECTA 16, PERFECTA 32, PERFECTA 16-WRL and PERFECTA 32-WRL control panels and how it should be installed. In addition, the manual provides information about devices compatible with the control panel and how they are to be connected.

The PERFECTA series alarm control panels meet the requirements of the following standards: EN 50131-1 Grade 2, EN 50131-3 Grade 2, EN 50131-6 Grade 2, EN 50130-4 and EN 50130-5 Class II.

2. Features

System structure

- 2 partitions (group of zones).
- Each zone can be assigned to two partitions.

Zones

- 8 programmable hardwired zones on the control panel mainboard:
 - support for NO and NC type detectors, as well as roller shutter and vibration detectors,
 - support for Single EOL and Double EOL configuration.
- Electrical protection of all zones.
- Maximum number of programmable zones:
 - 16 (PERFECTA 16 and PERFECTA 16-WRL),
 - 32 (PERFECTA 32 and PERFECTA 32-WRL).
- 20 zone types.

Outputs

- 4 programmable hardwired outputs on the control panel mainboard:
 - 2 high-current outputs,
 - 2 low-current outputs, OC type.
- Maximum number of programmable outputs:
 - 12 (PERFECTA 16 and PERFECTA 32),
 - 16 (PERFECTA 16-WRL and PERFECTA 32-WRL) – outputs with numbers from 13 to 16 are dedicated outputs for operating the MSP-300 wireless sirens.
- 23 performed functions.
- 2 power supply outputs on the control panel mainboard.
- Electrical protection of all outputs.

Communication bus

- Capability to connect keypads and expansion modules.
- Electrical protection of communication bus.

Wireless devices **only PERFECTA 16-WRL and PERFECTA 32-WRL**

- Support for 433 MHz radio devices manufactured by SATEL:
 - up to 16 (PERFECTA 16-WRL) / 32 (PERFECTA 32-WRL) detectors,
 - up to 4 sirens,
 - up to 4 keypads,

- up to 15 keyfobs.
- Encrypted radio communication.
- Two-way communication with wireless keypads and sirens.
- Up to 6 control functions available from keyfob.

Communication

- Built-in GSM/GPRS communicator.
- Dual SIM support (nano-SIM).

Reporting

- Reporting events to two monitoring stations.
- Support for Contact ID and SIA communication formats.
- Sending event codes to the monitoring station via:
 - GPRS,
 - GSM voice channel,
 - SMS messages.
- Defining priority for various ways to report events.

Messaging

- Event notification to 8 phone numbers in the form of:
 - 16 voice messages,
 - SMS messages with automatically generated content.
- Built-in voice module to enable playback of voice messages for the needs of telephone messaging.
- Informing users of the PERFECTA CONTROL application about events using push notifications.

SMS control

- Alarm system control using SMS messages.

PERFECTA CONTROL mobile application

- Operating the alarm system from mobile devices:
 - control of the alarm system,
 - checking the alarm system status.

Acoustic alarm verification

- Possibility of listening in to sounds from the protected premises over the telephone.

Event log

- 3584 events.

Users

- 15 users.
- Capability to assign to the user:
 - code,
 - keyfob.
- Authority level determining the scope of access to the system.

Timers

- 8 timers to automatically:
 - arm/disarm the partitions,
 - control the outputs (switching the lights on/off, watering the garden, etc.).

Programming

- Local programming:
 - keypad,
 - computer with the PERFECTA SOFT program installed, connected to the control panel RS-232 (TTL) port.
- Remote programming using a computer with PERFECTA SOFT program installed, via GPRS.

Control panel firmware update

- Updating the firmware via a computer connected to the RS-232 (TTL) port of the control panel.
- Updating the firmware via GPRS communication and the UPSERV update server (remote update).

Built-in power supply

- Switching-mode power supply 12 V / 2 A.
- Short-circuit protection.
- Battery status monitoring and low battery cut-off circuit.

3. Keypads

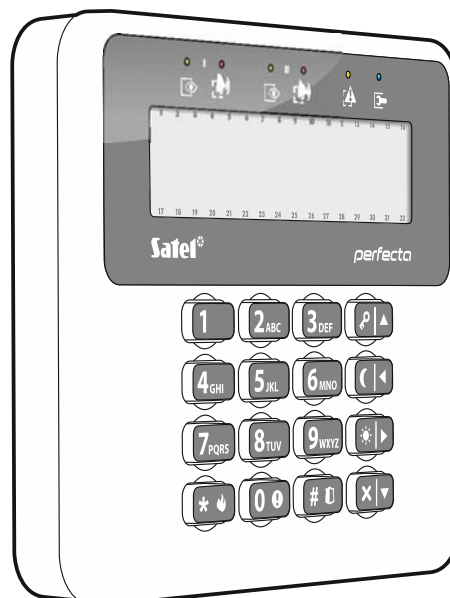

Fig. 1. PRF-LCD / PRF-LCD-WRL keypad.

SATEL offers the following keypads for PERFECTA alarm control panels:

PRF-LCD – hardwired LCD keypad with mechanical keys,

PRF-LCD-WRL – wireless LCD keypad with mechanical keys (supported by PERFECTA 16-WRL and PERFECTA 32-WRL control panels).



The alarm system should include at least one keypad.

The wireless keypads respond to the user actions more slowly than the wired ones.

3.1 Keypads features

- Display 2 x 16 characters with backlight.
- LEDs indicating the status of the partitions and the system.
- 12 keys, bearing designations according to telephone standard and intended for entering data.
- 4 additional keys for menu navigation and arming/disarming.
- Backlit keys.
- Tamper contact reacting to the enclosure opening or detaching from the wall.

4. Expansion modules

You can connect to the control panel the following expanders:

INT-RX-S – 433 MHz keyfobs receiver expansion module. Enables users to control the alarm system using the 433 MHz keyfobs. **only PERFECTA 16 / PERFECTA 32**

INT-E – zone expander. Adds 8 programmable hardwired zones to the security system.

INT-O / INT-ORS – output expander. Adds 8 programmable hardwired outputs to the security system.

5. Wireless devices **PERFECTA 16-WRL / PERFECTA 32-WRL**

The PERFECTA 16-WRL / PERFECTA 32-WRL control panel supports the following 433 MHz wireless devices:

MFD-300 – wireless water flood detector.

MGD-300 – wireless glass-break detector.

MMD-300 – wireless magnetic contact.

MMD-302 – wireless magnetic contact with input for roller shutter detector.

MPD-300 – wireless passive infrared detector.

MSD-300 – wireless smoke and heat detector.

MSP-300 – wireless outdoor siren.

PRF-LCD-WRL – wireless keypad.

6. System installation



Disconnect power before making any electrical connections.

The following tools will be useful during installation:

- blade screwdriver 2.5 mm,
- Phillips screwdriver,
- precision pliers,
- flat nose pliers,
- drill with a set of drill bits.

6.1 Installation plan

The installation must be preceded by preparation of a plan of the security alarm system. It is advisable to draw up a sketch of the premises and mark on it all the devices that are to be included in the alarm system: control panel, keypads, detectors, sirens, expansion modules etc. Thick walls, metal partitions, etc. decrease the range of GSM signal. Keep this in mind when choosing the installation place for control panel. The control panel and other alarm system components should be installed within the protected area.

6.2 Estimation of the system current consumption

At the security system planning stage you should sum up the currents consumed by all devices included in the system (control panel mainboard, keypads, expansion modules, detectors, sirens, etc.). The calculation should take into account the battery charging current. If the sum of currents exceeds the maximum output current of the control panel power supply, expander with power supply or an additional power supply unit should be used.

The sum of currents consumed by the devices connected to the power supply unit (expander with power supply) must not exceed the power supply output current.

If you plan to connect devices to particular power outputs (of the control panel, expander with power supply, etc.), remember that the sum of currents consumed by these devices must not exceed the maximum current carrying capacity of those outputs.

6.3 Cabling

It is recommended that an unshielded non-twisted cable be used for making electric connections between devices included in the system.



If you use the twisted-pair type of cable, remember that CLK (clock) and DTA (data) signals must not be sent through one pair of twisted conductors.

Select cross-section of the power supply wires so that the supply voltage drop between the power supply and the supplied device should not exceed 1 V as against the output voltage.

In order to guarantee correct functioning of the system components it is important that resistance and capacitance of the signal wires be as low as possible. When the distances between the devices are greater, several wires connected in parallel may have to be used for each signal, in order to reduce conductor resistance. This, however, may lead in consequence to an increase in conductor capacitance. Too high resistance or capacitance of the cables connecting the control panel to keypads or expansion modules can prevent the devices from working correctly (e.g. the control panel will be unable to identify devices, absence of devices will be reported, etc.). When selecting the length of cables, follow recommendations set out in sections on connection of particular types of devices.

Avoid running the cables in parallel to or in close vicinity of the 230 V AC wires, as this may result in malfunctioning of the system.

6.4 Installation of control panel



The control panel mainboard contains electronic components sensitive to electric charges.

Before connecting the mainboard to power supply source (battery, alternating voltage from transformer), you must first complete all the installation work with hardwired devices (connection of keypads, expansion modules, detectors etc.).

The control panel should be installed indoors, in spaces with normal humidity of air. The control panel must be protected against unauthorized access. The installer should provide protection for the users and service personnel by using a suitable device enclosure.

A 230 V AC power supply circuit with protective grounding must be available at the control panel installation place.

6.4.1 Description of the mainboards

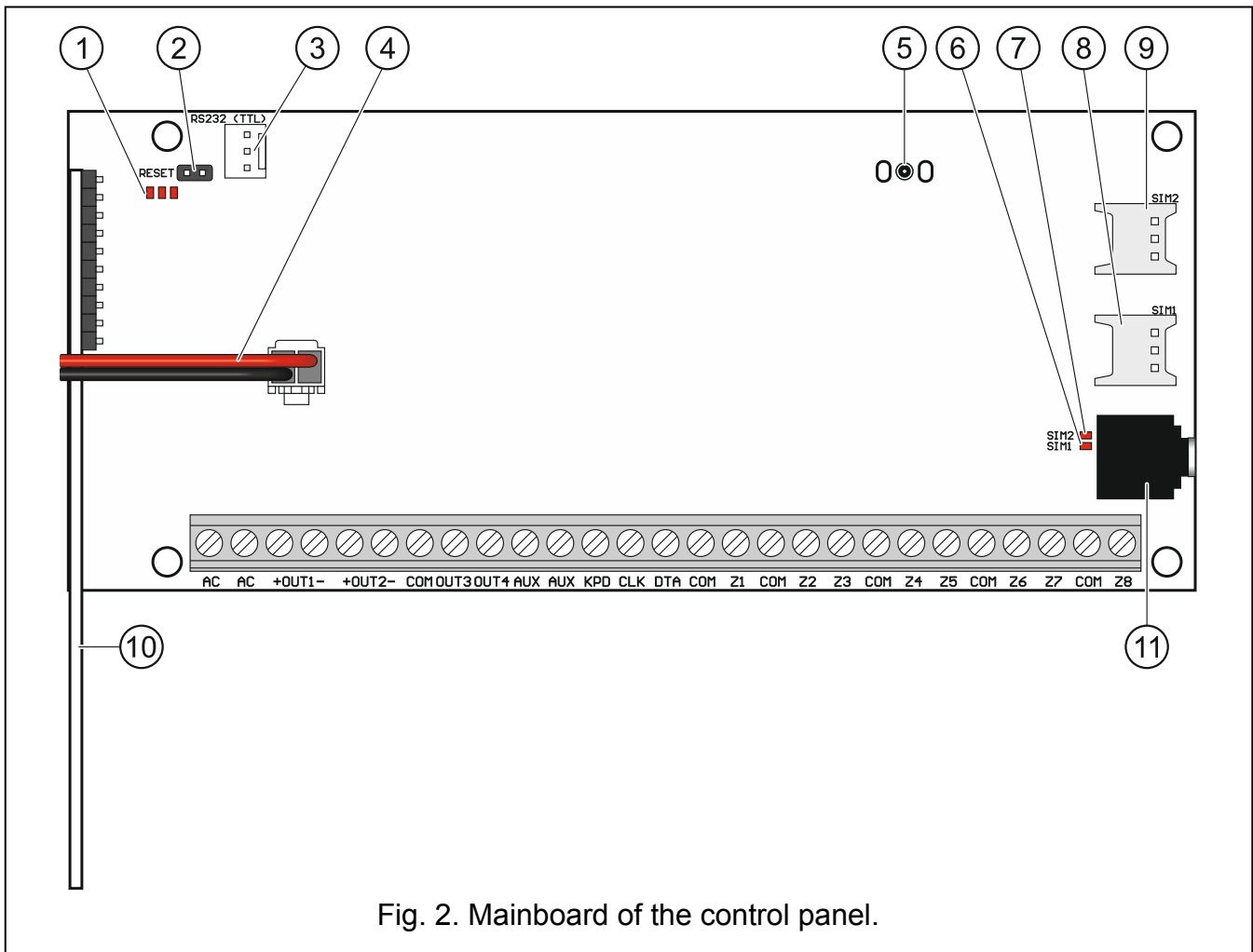

Fig. 2. Mainboard of the control panel.

- ① LED indicators:
 - left – ON when the listen-in function is in use.
 - center – ON when the battery is being tested.
 - right – ON when the GSM/GPRS communicator is on.
 - ② RESET pins for emergency starting the control panel (see: “Emergency procedure of the control panel start-up” p. 17).
 - ③ RS-232 (TTL) port.
 - ④ battery connection cables (red +, black -).
 - ⑤ connector for antenna (the recommended antenna: ANT-GSM-I from SATEL).
- i** *Connect the antenna only when the control panel power is off. Be particularly careful when connecting the antenna. After the antenna has been connected, put in place the plastic locking device of the connector.*
- ⑥ SIM1 LED. The LED is on, when the card installed in the SIM 1 slot is active.

⑦ SIM2 LED. The LED is on, when the card installed in the SIM 2 slot is active.

i | *The SIM1 or SIM2 LED is on even if no card is installed.*

⑧ SIM1 slot in which the first SIM card is to be installed.

⑨ SIM2 slot in which the second SIM card is to be installed.

i | *Inserting the SIM card into its slot before programming the card PIN code in the control panel is not recommended.*

⑩ wireless system module. **only PERFECTA 16-WRL and PERFECTA 32-WRL**

⑪ mini-jack socket for connecting microphone.

Description of terminals:

- AC** - power input (18 V AC).
- +OUT1-, +OUT2-** - programmable high-current outputs. +12 V DC voltage is always present at the “+” terminal. The “-” terminal is either shorted to or disconnected from the common ground, depending on the output status (active/inactive) and polarity.
- OUT3, OUT4** - programmable low-current outputs, OC type (disconnected from common ground / shorted to common ground).
- COM** - common ground.
- AUX** - +12 V DC power output.
- KPD** - +12 V DC power output.
- DTA** - communication bus data.
- CLK** - communication bus clock.
- Z1...Z8** - zones.

6.5 Connecting devices to the communication bus

i | *The bus wires must be run in one cable.*

The total length of the expander bus may not exceed 600 m.

The device can be powered directly from the control panel, if the distance to the control panel does not exceed 300 m. Where the distance is greater, another power source must be provided for the device (power supply or expander with power supply).

The Table 1 shows the number of wires required for correct connection of the device to the expander bus if conductors with 0.5 mm diameter are used.

| | CLK | DTA | COM |
|-------------|-----------------|-----|-----|
| Distance | Number of wires | | |
| up to 300 m | 1 | 1 | 1 |
| 300-600 m | 2 | 2 | 2 |

Table 1.

For most devices to be connected to the communication bus, setting of a suitable address is required. Two devices must not share the same address (otherwise their identification will be impossible). For information on the requirements related to address setting, please refer to the sections describing how specific devices are to be connected.

6.5.1 Connecting keypads

The control panel supports up to 4 keypads. These can be either wired or wireless keypads (the wireless ones can only be installed after starting the control panel). Addresses of the keypads must be set within the range from 0 to 3. For how to program addresses of the keypads, please refer to p. 17.

Mounting the PRF-LCD keypad

The keypad is designed for indoor installation. The place of installation should be readily accessible to the system users.

1. Open the keypad enclosure (Fig. 3).

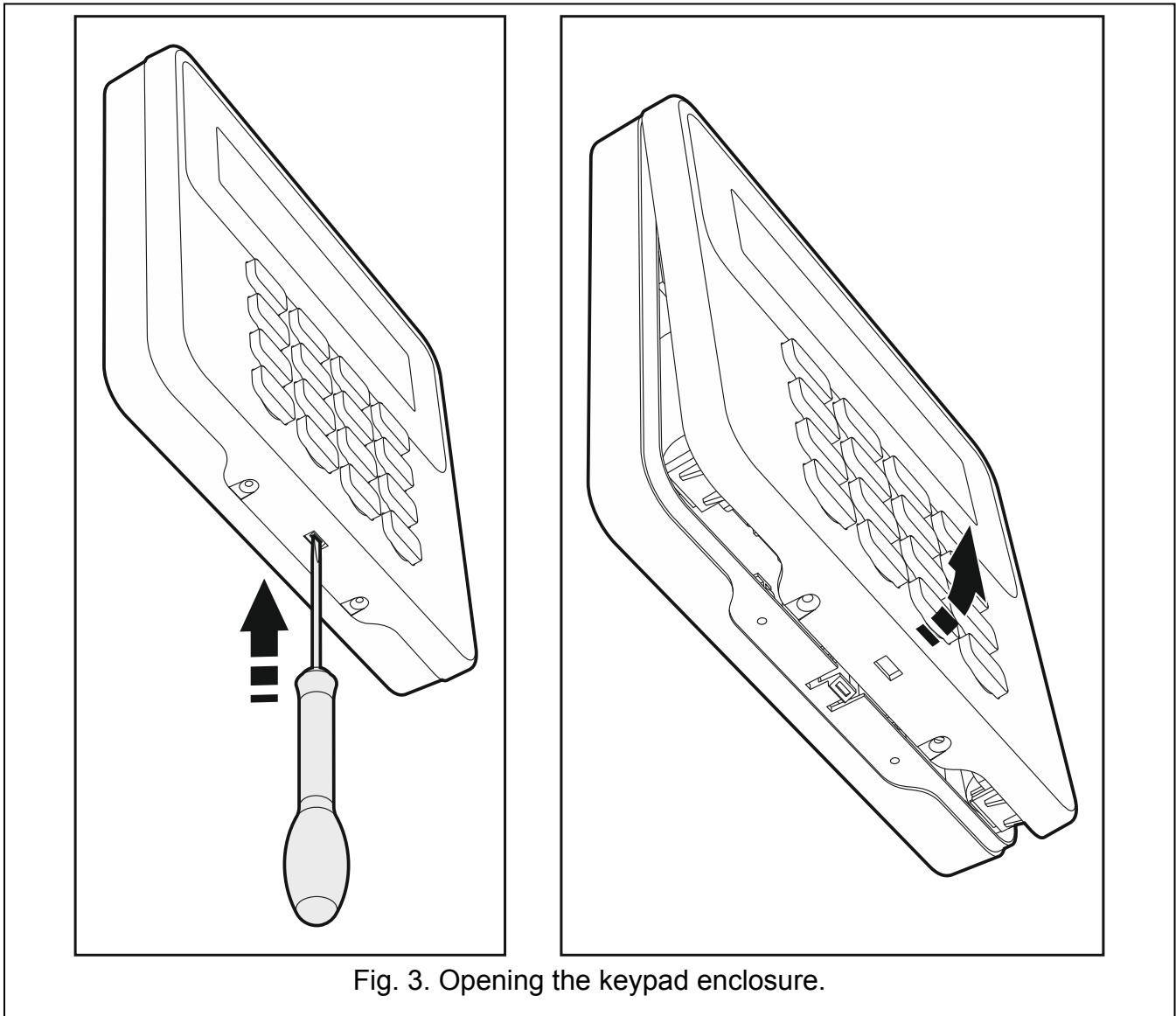

2. Put the enclosure base on the wall and mark the location of mounting holes.
3. Drill the holes in the wall for wall plugs (screw anchors).
4. Run wires through the opening in the enclosure base.
5. Using wall plugs (screw anchors) and screws, fasten the enclosure base to the wall. The wall plugs and screws must be selected so as to suit the mounting surface (must be different for concrete and brick, different for plaster or wood, etc.).
6. Connect the keypad terminals to the corresponding terminals of the control panel (see: Fig. 4).
7. Put the cover on the catches and snap the enclosure shut.

8. Lock the cover using screws.

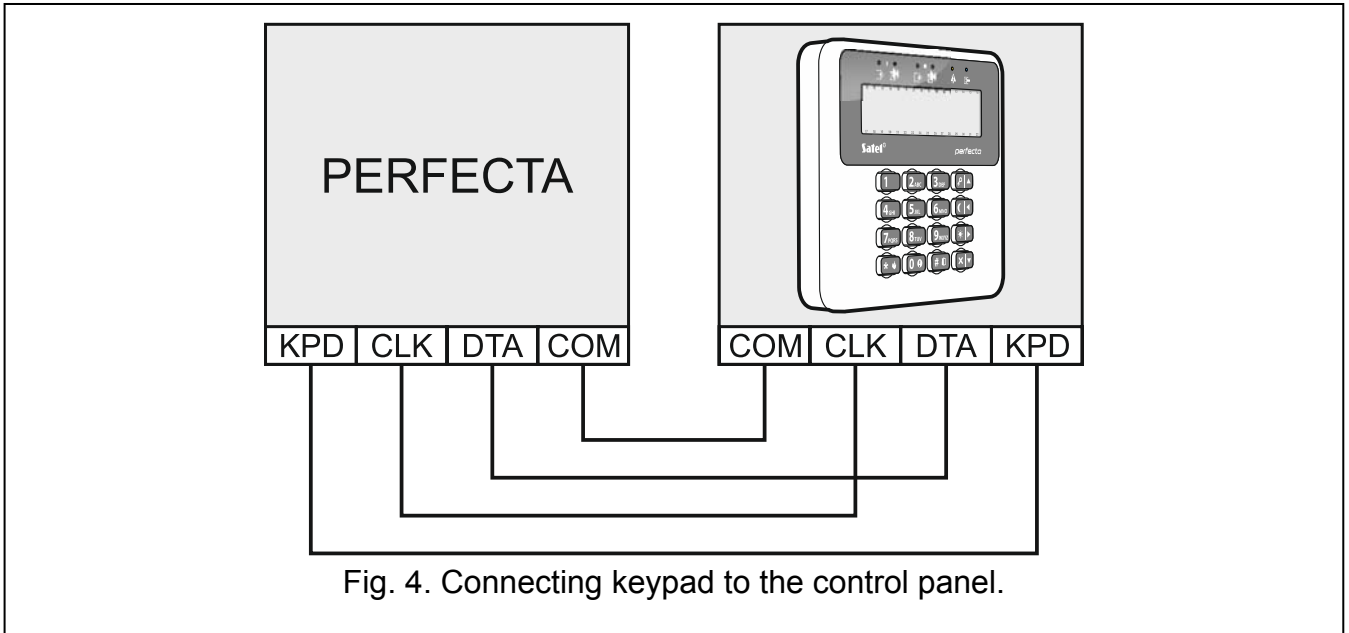

6.5.2 Connecting 433 MHz keyfobs receiver expansion module PERFECTA 16 / PERFECTA 32

You can connect the INT-RX-S expansion module to the PERFECTA 16 / PERFECTA 32 control panel. The module enables 433 MHz keyfobs to be assigned to the users (up to 15 keyfobs). Address 7 (07h) must be set in the module.

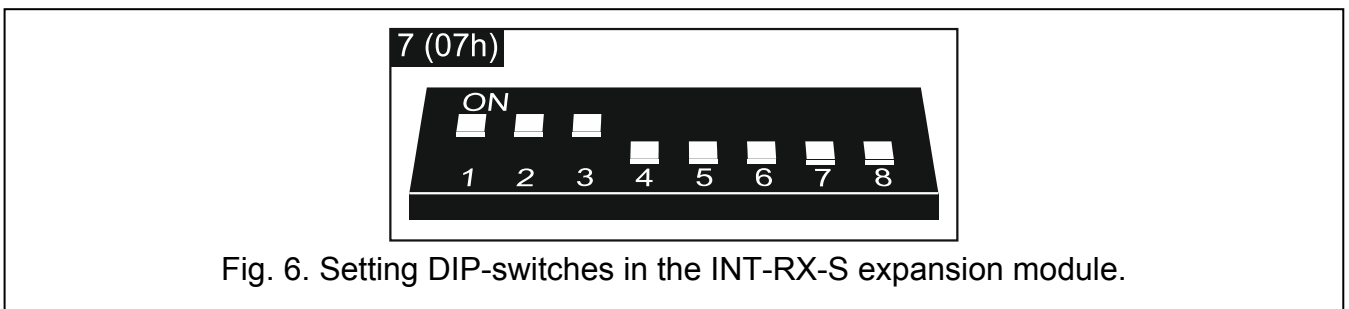
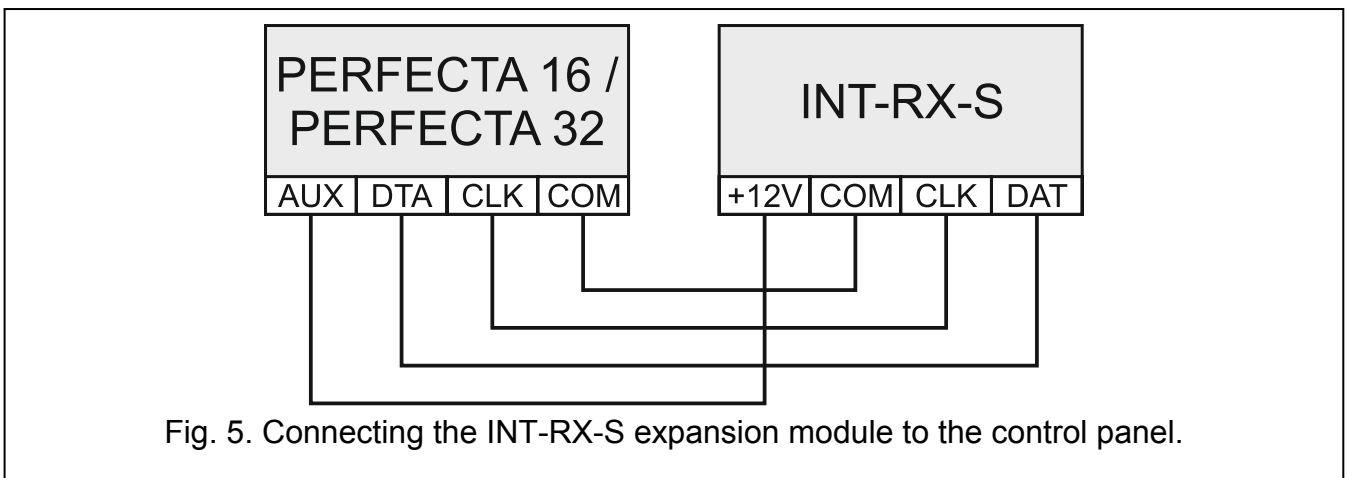

6.5.3 Connecting the hardwired zone expanders

The following expanders can be connected to the control panel:

- PERFECTA 16 / PERFECTA 16-WRL: 1 INT-E zone expander,
- PERFECTA 32 / PERFECTA 32-WRL: 3 INT-E zone expanders.

Each expander allows adding 8 programmable wired zones to the system.

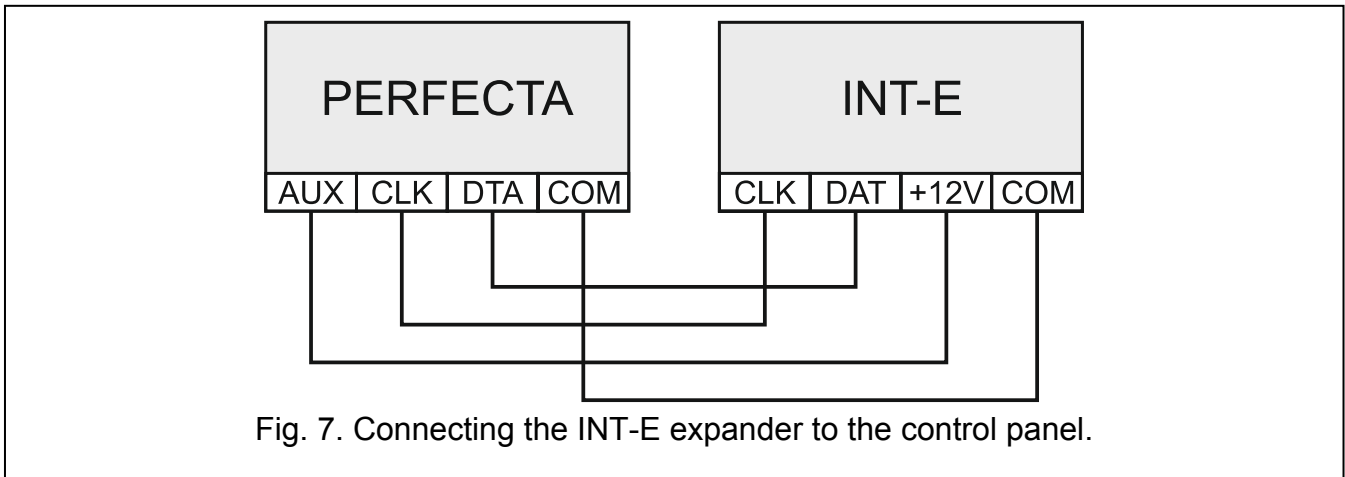

Fig. 7. Connecting the INT-E expander to the control panel.

The following address must be set in the zone expander:

- PERFECTA 16 / PERFECTA 16-WRL: 12 (0Ch),
- PERFECTA 32 / PERFECTA 32-WRL: 12 (0Ch), 13 (0Dh) or 14 (0Eh).

The DIP-switch 10 must be set to the OFF position.

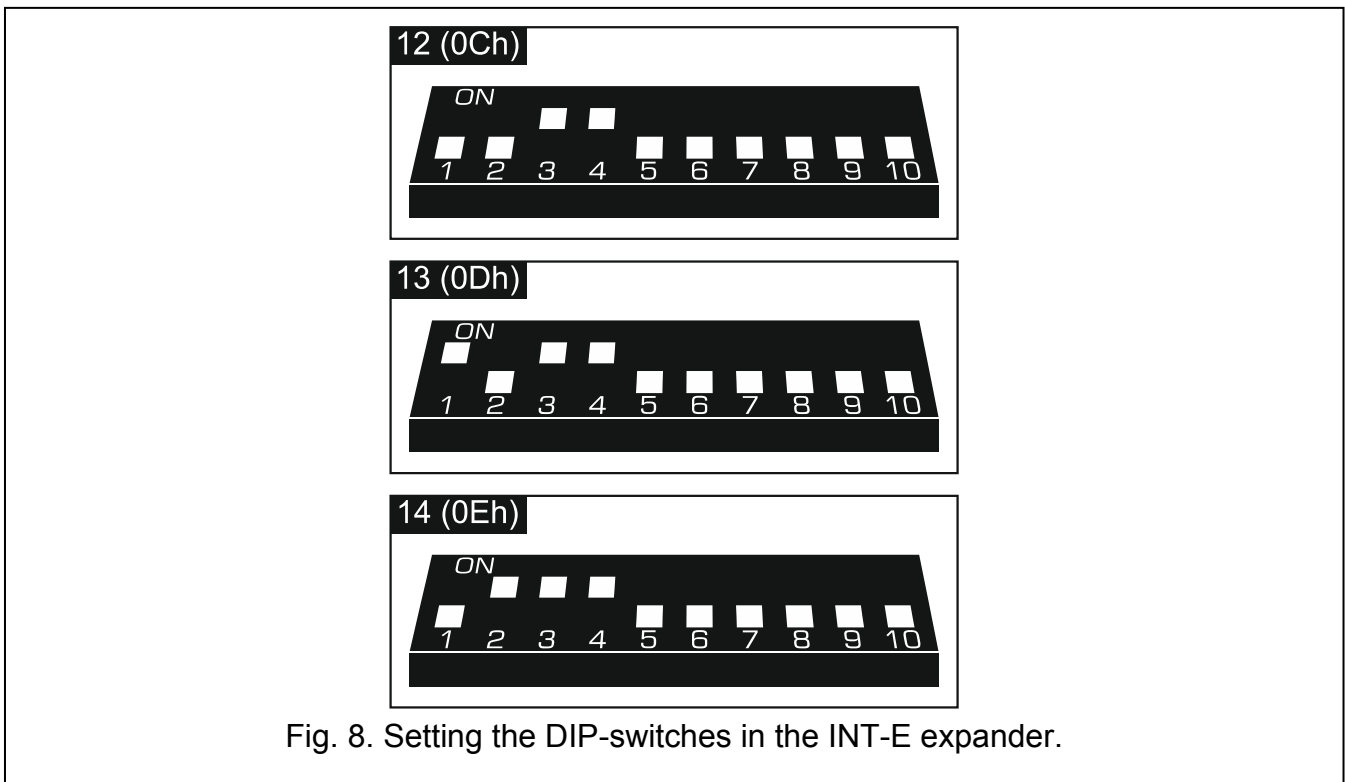

Fig. 8. Setting the DIP-switches in the INT-E expander.

Table 2 shows numbering of the expander zones depending on the address set. If a number of expander zone coincides with a number of wireless zone, the expander zone will not be supported.

| Expander address | | Zone numbers |
|------------------|---------------|--------------|
| decimally | hexadecimally | |
| 12 | 0C | 9-16 |
| 13 | 0D | 17-24 |
| 14 | 0E | 25-32 |

Table 2.

i | The expander can be identified as INT-E (no dedicated power supply is connected to the expander) or INT-EPS (dedicated power supply is connected to the expander).

6.5.4 Connecting the hardwired output expander

You can connect the INT-O or INT-ORS expander to the control panel. This enables expansion of the system by adding 8 programmable wired outputs.

Address 15 (0Fh) must be set in the expander. In the case of the INT-ORS expander, the DIP-switch 10 must be set to the ON position.

i | The expander can be identified as INT-O (no dedicated power supply is connected to the expander) or INT-OPS (dedicated power supply is connected to the expander).

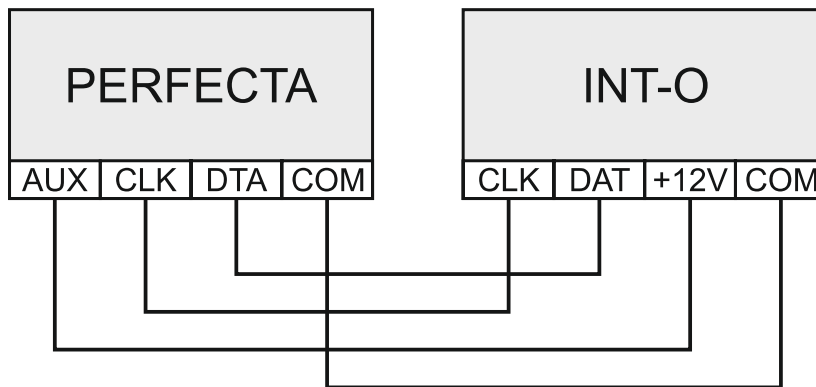

Fig. 9. Connecting the INT-O expander to the control panel.

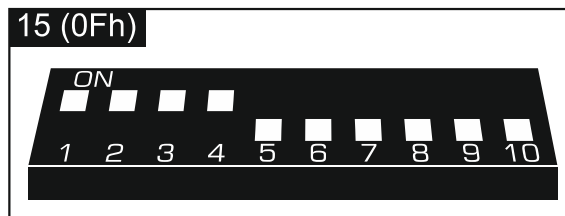

Fig. 10. Setting DIP-switches in the INT-O expander.

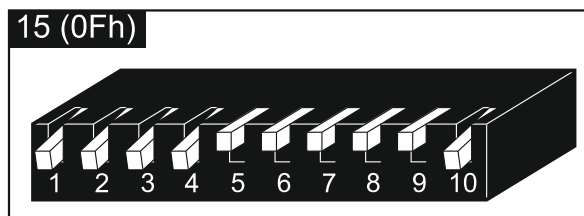

Fig. 11. Setting DIP-switches in the INT-ORS expander.

6.6 Connecting detectors and other devices to the zones

Zones of the control panel support the following wiring configurations:

NC – wiring configuration that allows connecting a detector with NC (normally closed) alarm output. Opening the circuit will trigger an alarm.

NO – wiring configuration that allows connecting a detector with NO (normally open) alarm output. Closing the circuit will trigger an alarm.

EOL – wiring configuration that allows connecting a detector with NC or NO alarm output. An EOL resistor must be used in the circuit. Alarm will be triggered by closing or opening the circuit.

2EOL/NC – wiring configuration that is recommended when connecting a detector with NC alarm output and tamper output. Two EOL resistors must be used in the circuit. The zone can distinguish between 3 states: normal, alarm and tamper.

2EOL/NO – wiring configuration similar as 2EOL/NC, but for detectors with the NO alarm output.

Shutter – wiring configuration that allows connecting a roller shutter detector.

Vibration – wiring configuration that allows connecting a vibration detector. You can also connect to the zone a detector with NC alarm output (e.g. vibration detector and magnetic contact can be connected in series).

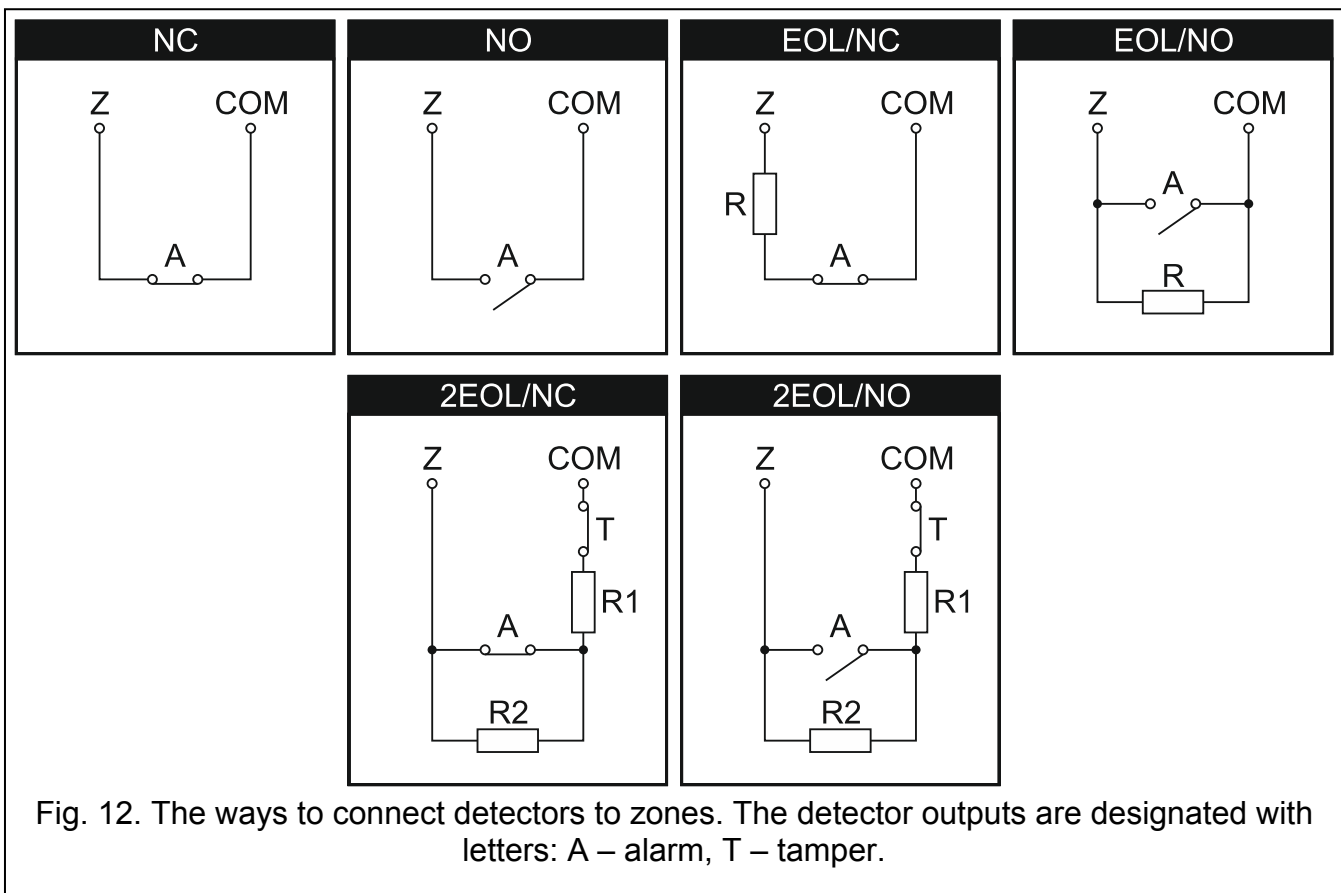

Fig. 12. The ways to connect detectors to zones. The detector outputs are designated with letters: A – alarm, T – tamper.

End-of-line resistors

For the Single EOL configuration, use a 2.2 k Ω resistor to close the circuit. For the Double EOL (2EOL) configuration, use two 1.1 k Ω resistors.

6.7 Connecting the sirens



It is recommended that the control panel be started without connected sirens. This will prevent accidental triggering of the alarm after the control panel is started.

Depending on the siren type:

- sirens without own power supply (e.g. SP-500, SP-4001, SP-4003, SPL-2010, SPW-100, SPW-210, SPW-220) – high-current outputs are to be used to trigger the signaling,

- sirens with own power supply (e.g. SP-4002, SP-4004, SP-4006, SP-6500, SPLZ-1011, SD-3001, SD-6000) – it is recommended to use low-current outputs to trigger the signaling, and high-current ones – to supply power.

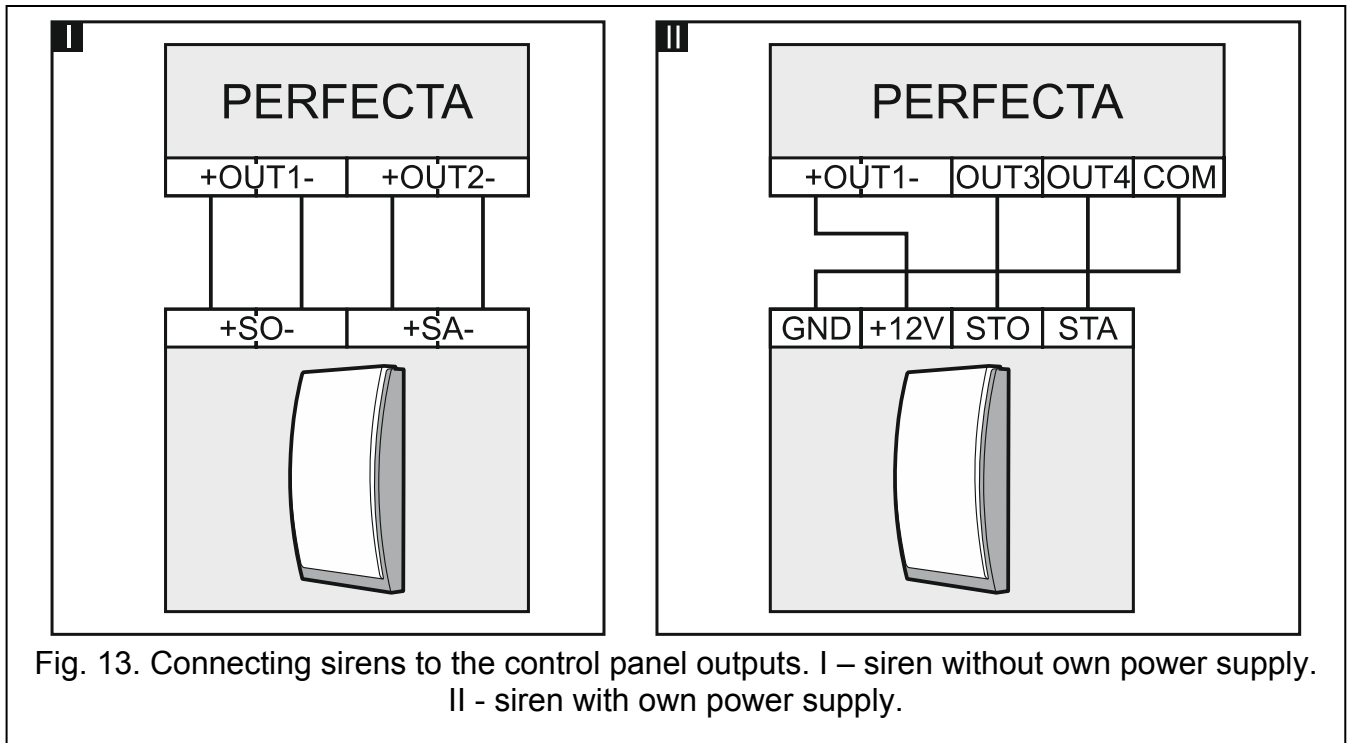

6.8 Connecting the microphone

The microphone will allow the users to listen in to the sounds from the protected premises after establishing telephone connection with the control panel. SATEL offers the MIC-1 microphone, which can be connected to the mini-jack socket on the control panel. If you decide to use another type, it should be an electret microphone, e.g. a typical computer microphone.

When selecting the microphone installation place, bear in mind that curtains, drapes, upholstery, acoustic tiles, etc. absorb sound and, as a result, make it difficult, if not impossible, to use the listen-in feature. It is not advisable to install the terminal in the vicinity of equipment which generates noise during operation (e.g. fans, air conditioners, refrigerators).

6.9 Connecting the power supply and starting the control panel



Do not connect power until all installation operations are completed.

6.9.1 Main power supply

The control panel requires 18 V AC ($\pm 10\%$) power supply. It is recommended that a transformer with 40 VA rating be used.

The transformer should be permanently connected to the 230 V AC mains supply. Before you make the cabling, familiarize yourself with the electrical installation of the facility. Make sure that the circuit you choose for powering the control panel will be always alive. The circuit must be provided with a 2-pole switch disconnecter with at least 3 mm contact separation and/or short-circuit protection with a 16 A time-delay fuse. The owner or user of the alarm system should be instructed on how to disconnect the transformer from the mains (e.g. by indicating the fuse which protects the control panel supply circuit).



Do not connect two devices with power supply to one-section transformer.

Before connecting transformer to a circuit from which it will be powered, make sure the circuit is de-energized.

6.9.2 Backup power supply

A 12 V lead-acid sealed battery should be connected to the control panel as a backup power source. The battery capacity must be adequately selected to match current consumption in the system. According to EN 50131 Grade 2, the battery must ensure operation of the system without mains supply for 12 hours.

If the battery voltage drops below 11 V for longer than 12 minutes (3 battery tests), the control panel will indicate battery failure. When the voltage goes down to approx. 10.5 V, the battery will be disconnected.



Do not connect deeply discharged battery to the control panel (with voltage across unloaded terminals below 11 V). The battery should be precharged with a proper charger.

The used batteries must not be discarded, but should be disposed of in accordance with the existing rules for environment protection.

6.9.3 Control panel power-up / start-up procedure

1. De-energize the 230 V AC circuit to which the transformer is to be connected.
2. Connect the 230 V AC wires to the terminals of transformer primary winding.
3. Connect the terminals of transformer secondary winding to the control panel AC terminals. To make the connection, use flexible conductors with a cross-section of 0.5 – 0.75 mm², or rigid conductors with a cross-section of 1 – 2.5 mm².
4. Connect the battery to the dedicated leads (positive terminal to RED lead, negative terminal to BLACK lead). If the battery has screw-type cable lugs, use adapters delivered with the control panel (do not cut off the battery cable lugs). **The control panel will not start after connecting the battery alone.**
5. Turn on 230 V AC power supply in the circuit to which the transformer is connected. The control panel will start operating.



The above mentioned power-up sequence (first the battery, then the 230 V AC mains) will ensure proper operation of the power supply unit and the electronic protection circuits, thus preventing damage to the alarm system components caused by installation mistakes, if any.



If it is necessary to de-energize the control panel, turn off the main power supply (AC) first, and the backup power supply (battery) afterwards. Observe the above described procedure when reconnecting the power supply.

6.9.4 Starting the service mode

If, after starting the alarm control panel, you want to perform any operations that not require power-off (e.g. to adjust sensitivity in wired detectors), enter the service mode.



When the control panel is running in service mode, tamper alarms are not generated.

1. Enter the **service code** (by default: 12345) and press .
2. User menu appears.
3. Press .

4. When the → cursor shows the SERVICE MODE function, press .
5. Service mode menu will be displayed (the → cursor will show the END SM function).

6.9.5 Emergency procedure of the control panel start-up

If the control panel fails to start properly, keypads are not supported, codes are not accepted by the control panel etc., despite all connections having been made correctly, follow the steps below:

1. Turn off the control panel power supply (first disconnect the AC power, and then the battery).
2. Put a jumper on the RESET pins.
3. Turn on the control panel power supply (first connect the battery and then the AC power).
4. Wait a few seconds (until LEDs next to the RESET pins stop blinking) and remove the jumper from the RESET pins. The control panel will enter the service mode. The service mode menu will be displayed on the wired keypad with the lowest address.



If there is no wired keypad in the alarm system or there is no communication with the wired keypads (e.g. when the communication bus is shorted), you can get access to the service mode menu from the wireless keypad with the lowest address. Press any key on this keypad within 30 seconds of removing jumper from the RESET pins.

The service mode menu will not be displayed, if the DISABLE SERVICE MODE option is enabled in the control panel. The "Factory settings ? 1=Yes" message will be displayed on the keypad with the lowest address. You can press to restore the factory default settings. The service mode menu will not be displayed until the factory settings are restored.

6.9.6 First steps after starting-up the control panel

Control panel with wired keypads

If wired keypads are connected to the control panel, then, after starting the control panel with factory settings:

1. Set correct, individual addresses in the wired keypads.
2. Run the function of identification of devices connected to the communication bus of the control panel.

Control panel without wired keypads **PERFECTA 16-WRL / PERFECTA 32-WRL**

If no wired keypads are connected to the control panel, then, after starting the control panel with factory settings:

1. Connect computer to alarm control panel.
2. Use the PERFECTA SOFT program to add wireless keypads.
3. Run the function of identification of devices connected to the communication bus of the control panel.

6.10 Programming addresses for the hardwired keypads

An individual address from the 0 to 3 range must be set for each keypad. By default, address 0 is preset for all wired keypads. After starting the alarm control panel with factory default settings, all keypads connected to the bus are supported, no matter what their addresses are. This allows you to program individual address for the keypads.



Remember to program an individual address if a new keypad is connected to the already functioning alarm system.

6.10.1 Programming the address by means of the service function



The address programming function can be started from either a wired or wireless keypad, but it will only allow setting addresses in the wired keypads.

1. Start the service mode (see: “Starting the service mode” p. 16).
2. Press successively **2_{ABC}** **0** **#** **0** to run the 20.KPD.ADDRESS function.
3. Information on the current address and permissible address range will be displayed on all wired keypads (see Fig. 14).

The image shows a rectangular LCD display with a pixelated font. The text on the display reads: "This LCD address" on the first line, and "(n, 0-3):" followed by a blank space and a horizontal line on the second line.

Fig. 14. Programming keypad address (n = current address).

4. On the keypad the address of which you want to change, press the key whose digit corresponds to the new address.
5. Press *** 0** to finish the function (the function will be finished automatically after 2 minutes since it was launched). The keypad will be restarted.

6.10.2 Programming the address without entering the service mode

This way of address programming is useful when the keypad operation is blocked and starting the service mode is impossible.

1. Power off the keypad.
2. Disconnect wires from the keypad CLK and DTA terminals.
3. Short the CLK and DTA keypad terminals.
4. Power on the keypad.
5. Information on the current address and permissible address range will be displayed on the keypad (see Fig. 14).
6. Press the key whose digit corresponds to the new address (if you make a mistake, press *** 0** to restart the keypad – current address information will be displayed again).
7. Power off the keypad.
8. Open the CLK and DTA keypad terminals.
9. Connect wires properly to the CLK and DTA keypad terminals.
10. Power on the keypad.

6.11 Identification of devices connected to the bus

Devices connected to the communication bus will not be properly supported, unless they have been identified by the control panel. Identification of the devices is required after the first start-up of the control panel and then each time after a new device is added or the address was changed in a device supported by the control panel.



Disconnecting an identified device from the communication bus will trigger the tamper alarm.

6.11.1 Starting the identification function from keypad

1. Start the service mode (see: “Starting the service mode” p. 16).
2. Press successively **2_{ABC}** **1** **#** **0** to run the 21.IDENTIFICAT. function.

3. "Please wait..." message will appear.
4. After devices connected to the communication bus are identified, information on the number of devices connected to the bus will be displayed.



If information is displayed that there is a problem with a device with specific address, it means that a wrong address is set on the device (invalid for this type of device or the same address is set on at least two devices) or that the device is not supported.

5. Press  to exit the function.

6.11.2 Starting the identification function from PERFECTA SOFT program

1. Click on the "Hardware" tab.
2. Click on "Mainboard".
3. Click on "Detect connected modules".
4. When devices connected to the communication bus has been identified, information on the number of devices connected to the bus will be displayed.



In the event of any problems with identification (e.g. an invalid address is set in the device), a message will be displayed to inform you about the problem.

5. Click on "READ DATA FROM PANEL".

6.12 Installing the SIM card

Slots on the mainboard make it possible to install two nano-SIM cards.



If the control panel is to send data in GPRS technology, it is recommended that you use SIM cards with a dedicated tariff plan for M2M (machine-to-machine) communication.

If the SIM card requires entering the PIN code, program the PIN code before you install the card.

If a wrong PIN code is programmed, a trouble will be reported after using it. After 255 seconds the control panel will retry to use the PIN code. After the third attempt to use a wrong PIN code, the SIM card will be blocked. To unblock the card, enter the PUK code.

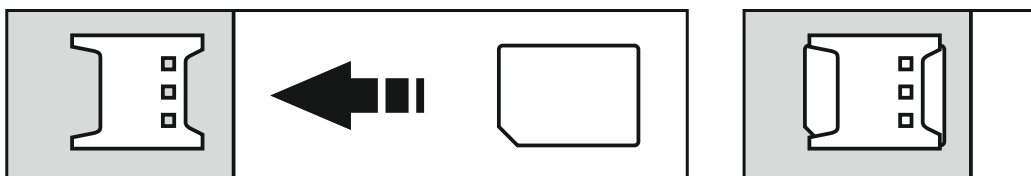

Fig. 15. Installing the nano-SIM card.

6.13 Connecting the computer to the control panel

You can connect the control panel RS-232 (TTL) port with the USB port on a computer. To make the connection, use the USB-RS converter offered by SATEL. Having connected the computer to the control panel, you can:

- configure the alarm system by using the PERFECTA SOFT program (communication is encrypted),
- update the control panel firmware.

6.14 Installation of wireless devices **PERFECTA 16-WRL / PERFECTA 32-WRL**

The PERFECTA 16-WRL / PERFECTA 32-WRL control panel supports:

- up to 4 wireless keypads,
- up to 16 (PERFECTA 16-WRL) / 32 (PERFECTA 32-WRL) wireless detectors,
- up to 4 wireless sirens.



After starting the control panel and identifying the devices used in conjunction with the control panel, you can proceed to install the 433 MHz wireless devices. Before installation of the wireless device:

1. Insert battery into the device.
2. Enroll the device in the control panel. You can do so by using the PERFECTA SOFT program or LCD keypad.
3. Check that transmissions from the device positioned in the planned installation location reach the control panel. To send a transmission, you can, for example, open the tamper switch on the device. If transmissions from the device in the expected place of installation do not reach the control panel, select another location. Sometimes, just moving the device ten to twenty centimeters will do. Do not secure the device permanently until making sure that the control panel receives transmissions from the device.



6.14.1 Adding new wireless devices

PERFECTA SOFT program



Adding wireless keypad

1. Click on the “Hardware” tab.
2. Click on one of the unused keypads. Address of this keypad will be assigned to the wireless keypad after the adding procedure is finished.
3. Click on .
4. The wireless device adding panel will be displayed.
5. In the “Serial no.” field, enter the serial number of the keypad. You will find it on the keypad electronics board.
6. Press any key on the keypad being added.
7. When the “Device's data read” message appears, click “OK”.
8. Click  to save changes to the control panel.











Adding wireless detector

1. Click on the “Zones” tab.
2. Click on one of the unused zones. The wireless detector will be assigned to this zone after the adding procedure is finished.
3. Click on .
4. The wireless device adding panel will be displayed.
5. In the “Serial no.” field, enter the serial number of the detector. You will find it on the electronics board or enclosure of the detector.
6. Open momentarily the detector tamper switch.
7. When the “Device's data read” message appears, click “OK”.
8. Click  to save changes to the control panel.

Adding wireless siren

1. Click on the “Outputs” tab.
2. Click on one of the unused outputs with a number from 13 to 16. The wireless siren will be assigned to this output after the adding procedure is finished.
3. Click on .
4. The wireless device adding panel will be displayed.
5. In the “Serial no.” field, enter the serial number of the siren. You will find it on the electronics board of the siren.
6. Open momentarily the siren tamper switch.
7. When the “Device's data read” message appears, click “OK”.
8. Click  to save changes to the control panel.



Keypad

1. Start the service mode (see “Starting the service mode” p. 16).
2. Press successively      to run the 1271.ADD function.
3. Enter the serial number of the wireless device. You will find it on the electronics board or enclosure of the device.
4. Press .
5. When the “Open tamper device” command is displayed,
 - to add keypad: press any key on the keypad being added,
 - to add detector or siren: open momentarily the tamper switch on the device being added.
6. The type and serial number of the device being added will be displayed (if nothing happens, you may have entered a wrong serial number – if this is the case, press , to exit the function).
7. Press .
8. When the “SELECT...” command is displayed, use the  and  keys to select:
 - when adding a keypad: the address to be assigned to the keypad,
 - when adding a detector: the zone to which the detector is to be assigned,
 - when adding a siren: the output to which the siren is to be assigned.
9. Press . The device will be added.



6.14.2 Removing wireless devices

PERFECTA Soft program



Removing wireless keypad

1. Click on the “Hardware” tab.
2. Click on the wireless keypad that is to be removed.
3. Click on .
4. In the window that will be displayed, click on “Delete” to confirm that you want to remove the keypad.
5. Click  to save changes to the control panel.









Removing wireless detector

1. Click on the “Zones” tab.
2. Click on the zone to which the detector you want to remove is assigned.
3. Click on .
4. In the window that will be displayed, click on “Delete” to confirm that you want to remove the detector.
5. Click  to save changes to the control panel.

Removing wireless siren

1. Click on the “Outputs” tab.
2. Click on the output to which the siren you want to remove is assigned.
3. Click on .
4. In the window that will be displayed, click on “Delete” to confirm that you want to remove the siren.
5. Click  to save changes to the control panel.

Keypad

1. Start the service mode (see “Starting the service mode” p. 16).
2. Press successively      to run the 1273.REMOVE function.
3. Use the  and  keys to select:
 - when removing a keypad: the keypad you want to remove,
 - when removing a detector: the zone to which the detector you want to remove is assigned,
 - when removing a siren: the output to which the siren you want to remove is assigned.
4. Press .
5. The type and serial number of the device to be removed will be displayed.
6. Press . The device will be removed.

7. Numeration of zones and outputs in the system

7.1 Numeration of zones

7.1.1 Hardwired zones

The zones on control panel main board have numbers from 1 to 8.

The zones in expanders are numbered depending on the address which is set in them:

- expander with address 12 (0Ch) – numbers from 9 to 16,
- expander with address 13 (0Dh) – numbers from 17 to 24,
- expander with address 14 (0Eh) – numbers from 25 to 32.

7.1.2 Wireless zones **PERFECTA 16-WRL / PERFECTA 32-WRL**

When adding wireless detectors, you select the numbers of zones that will be wireless ones.



If the number of a wired zone coincides with the number of a wireless zone, the wired zone will not be supported.

7.2 Numeration of outputs

7.2.1 Hardwired outputs

The outputs on control panel main board have numbers from 1 to 4.

The outputs in expander have numbers from 5 to 12.

7.2.2 Wireless outputs **PERFECTA 16-WRL / PERFECTA 32-WRL**

The wireless outputs have numbers from 13 to 16.

8. Specifications

8.1 Control panel

| | |
|--|-------------------------------|
| Supply voltage | 18 V AC $\pm 15\%$, 50-60 Hz |
| Recommended transformer | 40 VA |
| Standby current consumption | |
| PERFECTA 16 / PERFECTA 32 | 150 mA |
| PERFECTA 16-WRL / PERFECTA 32-WRL | 220 mA |
| Maximum current consumption | |
| PERFECTA 16 / PERFECTA 32 | 180 mA |
| PERFECTA 16-WRL / PERFECTA 32-WRL | 240 mA |
| Standby current consumption from battery | |
| PERFECTA 16 / PERFECTA 32 | 100 mA |
| PERFECTA 16-WRL / PERFECTA 32-WRL | 120 mA |
| Maximum current consumption from battery | |
| PERFECTA 16 / PERFECTA 32 | 160 mA |
| PERFECTA 16-WRL / PERFECTA 32-WRL | 180 mA |
| Power supply output voltage..... | 12 V DC $\pm 15\%$ |
| Power supply output voltage range..... | 10.5 V...14 V DC |
| Power supply output current | 2 A |
| Battery charging current..... | 500 mA |
| Battery failure voltage threshold | 11 V $\pm 10\%$ |
| Battery cut-off voltage | 10.5 V $\pm 10\%$ |
| High-current programmable outputs | 1000 mA / 12 V DC |
| Low-current programmable outputs | 25 mA / 12 V DC |
| KPD output | 500 mA / 12 V DC |
| AUX output | 500 mA / 12 V DC |
| Hardwired programmable zones..... | 8 |
| Maximum number of programmable zones | |
| PERFECTA 16 / PERFECTA 16-WRL | 16 |
| PERFECTA 32 / PERFECTA 32-WRL | 32 |
| Hardwired programmable outputs..... | 4 |
| Maximum number of programmable outputs | |
| PERFECTA 16 / PERFECTA 32 | 12 |
| PERFECTA 16-WRL / PERFECTA 32-WRL | 16 |

| | |
|---|--------------|
| Power supply outputs..... | 2 |
| Communication buses..... | 1 |
| Keypads..... | up to 4 |
| Partitions..... | 2 |
| Telephone numbers for messaging..... | 8 |
| Voice messages..... | 16 |
| Users..... | 15 |
| Timers..... | 8 |
| Event log..... | 3584 |
| Security grade according to EN50131..... | Grade 2 |
| Environmental class according to EN50130-5..... | II |
| Operating temperature range..... | -10...+55°C |
| Maximum humidity..... | 93±3% |
| Electronics board dimensions | |
| PERFECTA 16 / PERFECTA 32..... | 160 x 68 mm |
| PERFECTA 16-WRL / PERFECTA 32-WRL..... | 160 x 110 mm |
| Weight | |
| PERFECTA 16 / PERFECTA 32..... | 105 g |
| PERFECTA 16-WRL / PERFECTA 32-WRL..... | 115 g |

8.2 PRF-LCD keypad

| | |
|---|-------------------|
| Supply voltage..... | 12 V DC ±15% |
| Standby current consumption..... | 30 mA |
| Maximum current consumption..... | 50 mA |
| Environmental class according to EN50130-5..... | II |
| Operating temperature range..... | -10...+55°C |
| Maximum humidity..... | 93±3% |
| Enclosure dimensions..... | 139 x 124 x 22 mm |
| Weight..... | 246 g |

9. Manual update history

| Manual version | Introduced changes |
|----------------|---|
| 10/17 | <ul style="list-style-type: none"> Description of how to run the identification function from the PERFECTA SOFT program has been added (p. 19). |
| 10/18 | <ul style="list-style-type: none"> Information on INT-RX-S expansion module has been added (p. 6 and 11). Note about SIM1 and SIM2 control panel LEDs has been added (p. 9). Figure has been added to show the DIP-switches setting in the INT-ORS expander (p. 13). |

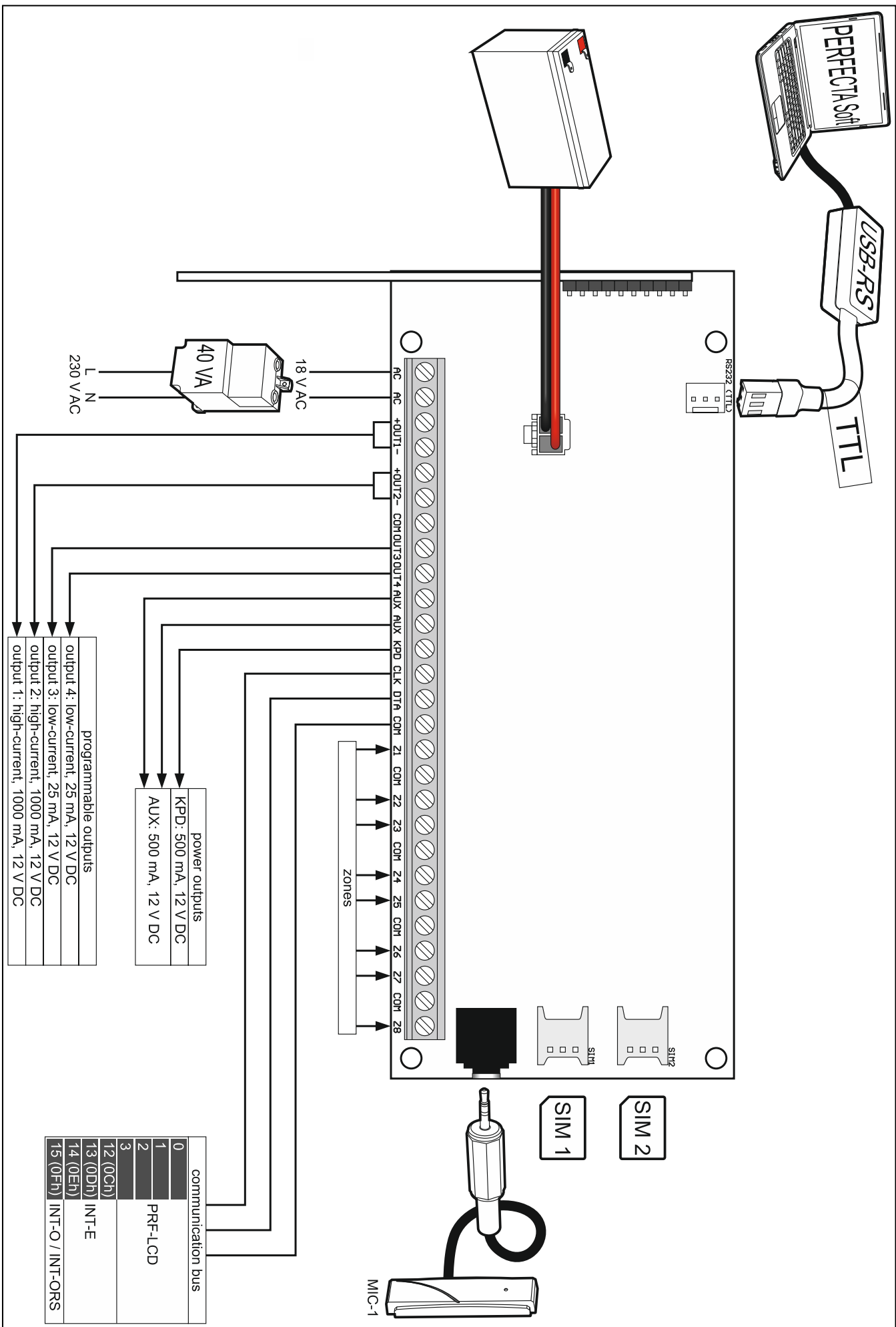

40 VA
230 V AC
L
N

18 V AC

- output 4: low-current, 25 mA, 12 V DC
- output 3: low-current, 25 mA, 12 V DC
- output 2: high-current, 1000 mA, 12 V DC
- output 1: high-current, 1000 mA, 12 V DC

- power outputs
- KPD: 500 mA, 12 V DC
- AUX: 500 mA, 12 V DC

| communication bus | |
|-------------------|-----------------|
| 0 | PRF-LCD |
| 1 | |
| 2 | |
| 3 | |
| 12 (0Ch) | INT-E |
| 13 (0Dh) | INT-E |
| 14 (0Eh) | INT-O / INT-ORS |
| 15 (0Fh) | INT-O / INT-ORS |

MIC-1